

# bRite Standard Retail scale

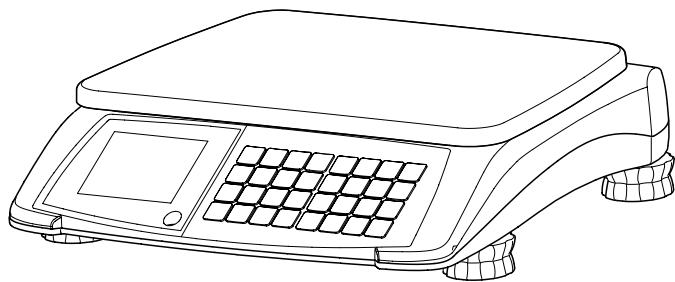

**METTLER TOLEDO**



# Contents

<b>1</b>	<b>Your new retail scale .....</b>	<b>4</b>
1.1	Most important functions.....	4
1.2	Device overview.....	4
1.3	Safety instructions.....	7
1.4	Legal for trade.....	7
<b>2</b>	<b>Setting up .....</b>	<b>8</b>
2.1	Scope of delivery.....	8
2.2	Requirements for scale's location.....	8
2.3	Setting up the scale.....	8
2.4	Inserting the batteries.....	9
2.5	Connecting to mains power.....	10
2.6	Turning scale on/off.....	10
2.7	Cleaning.....	10
<b>3</b>	<b>Operation .....</b>	<b>11</b>
3.1	Free input.....	11
3.2	Working with PLUs.....	11
3.3	Using tare.....	13
3.4	Zeroing.....	14
3.5	By-count operation.....	14
3.6	Accumulating.....	15
3.7	Change function.....	16
3.8	Fix unit price and/or tare.....	17
3.9	Hold function.....	18
3.10	Weighing with 100 g (1/2 lb / 1/4 lb) price unit.....	18
3.11	Switching weighing unit between kg and lb.....	19
3.12	Displaying the price to pay in EURO.....	19
3.13	Backlight function.....	19
<b>4</b>	<b>Operator setup.....</b>	<b>20</b>
4.1	Setup operation.....	20
4.2	Operator setup overview.....	21
<b>5</b>	<b>What do you do if....? .....</b>	<b>23</b>
<b>6</b>	<b>Technical data and accessories.....</b>	<b>24</b>
6.1	Technical data.....	24
6.2	Accessories.....	24
6.3	Compliance.....	25
<b>7</b>	<b>Appendix.....</b>	<b>26</b>
7.1	Periodical verification in the countries of the EEC.....	26
7.2	Disposal.....	27

# 1 Your new retail scale

## 1.1 Most important functions

Congratulations on your new scale.

This robust digital price computing scale with its hygienic design and battery operation facilitates comfortable mobile selling while maintaining the highest accuracy.

## 1.2 Device overview

### 1.2.1 Keyboard

The keyboard is divided into four sections. The advanced function keys depend on the region.

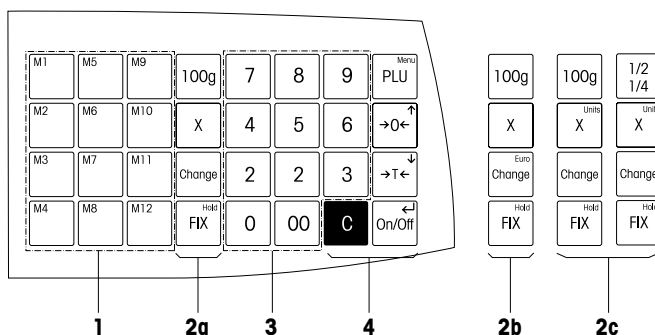

- 1 PLU preset keys
- 2a Advanced function keys, Basic (rest of the world)
- 2b Advanced function keys, Europe
- 2c Advanced function keys, versions for North America
- 3 Numeric keypad
- 4 Basic function keys



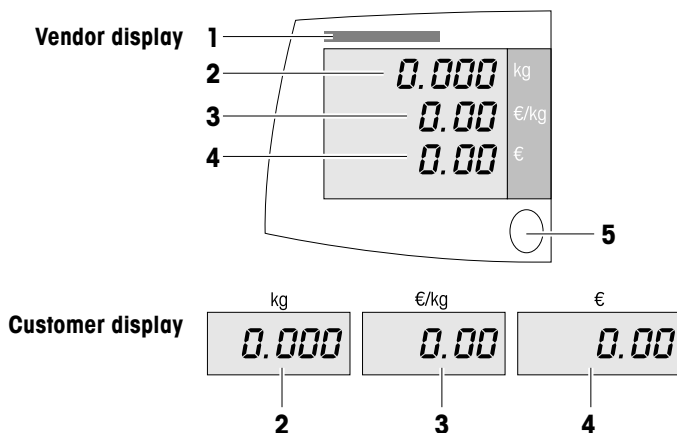

## Display

The display is laid out as follows from the customer and vendor point of view:



- 2 Calibration plate
- 3 Weight display
- 4 Unit price
- 5 Price
- 6 Level indicator

In addition to the weight and price, the following status messages and indicators can be displayed:

- ZERO** Scale is at center of zero
- PT** Keyboard tare or tare recalled from PLU
- NET** Net value (gross minus tare); push button tare exists
- FIX** Unit price and/or tare is fixed
- X** Scale is in by-count mode
- 100 g** 100 g pricing is activated
- 1/2** 1/2 lb pricing is activated
- 1/4** 1/4 lb pricing is activated
- Add** Scale is in accumulation mode; data exists in the accumulation memory
- Total** The displayed total price is added into the accumulation memory
-  Battery is approx. full
-  2/3 battery power left
-  1/3 battery power left
-  Battery power at a critical level

### 1.2.2 Connections and features on the underside

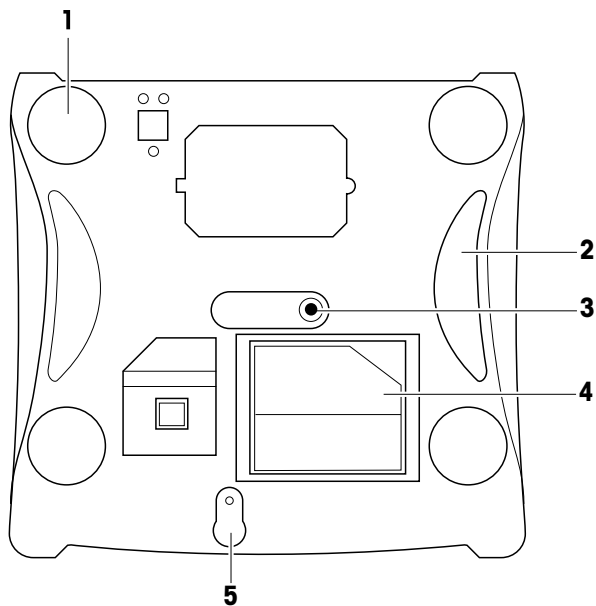

The following connections are located on the underside of the scale:

- 1** Adjustable feet
- 2** Grips
- 3** Power supply connection
- 4** Power supply storage box
- 5** Calibration button

## 1.3

### Safety instructions



#### Basic safety instructions

- ▶ Read these operating instructions prior to using your scale.
- ▶ Store these operating instructions in the vicinity of the scale for future reference.
- ▶ Do not open the scale.
- ▶ Always unplug the scale before cleaning.



#### Safety instructions for battery operation

- ▶ The battery must not come into contact with chemical solvents, oil or water.
- ▶ Keep batteries away from heat and fire.
- ▶ Do not open the battery.

## 1.4

### Legal for trade

When the scale is used in trade or a legally controlled application, it must be set up, verified and sealed in accordance with local weights and measures regulations. It is the responsibility of the purchaser to ensure that all pertinent legal requirements are met. As verification requirements vary by jurisdiction, the purchaser should contact their local weights and measures office if they are not familiar with the requirements.

For products sold in Europe, the verification process has been completed at the place of manufacture. These products have been sealed and the type plate includes supplemental metrology markings. They may be put into service immediately. If required by local W & M authorities, additional stickers will already be applied on the device.

For products sold in other regions, the verification process must be performed at the place of use.

To prevent access to calibration and metrological settings, the scale must be sealed using a paper seal or wire seal.

## 2 Setting up

### 2.1 Scope of delivery

- ▶ Check if the delivery is complete:
  - Scale
  - Stainless steel weighing pan
  - Power supply, stored in the power supply storage compartment under the scale
  - Operating instructions

### 2.2 Requirements for scale's location

The right location is critical to weighing accuracy.

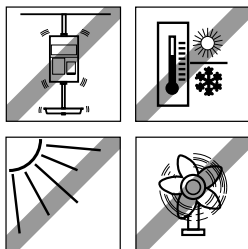

#### Conditions for an ideal location

- No shocks and vibrations
- No excessive temperature fluctuations
- No direct sunlight
- No strong drafts
- Select a stable, vibration-free and preferably horizontal location for your scale.

### 2.3 Setting up the scale

#### 2.3.1 Levelling the scale

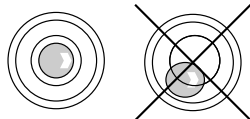

Only a perfectly levelled scale delivers accurate weighing results. The scale is equipped with a level indicator to make it easier to level the scale.

- ▶ To level the scale, turn the scale's adjustable feet until the air bubble in the level indicator is in the inner circle.



## 2.4

### Inserting the batteries

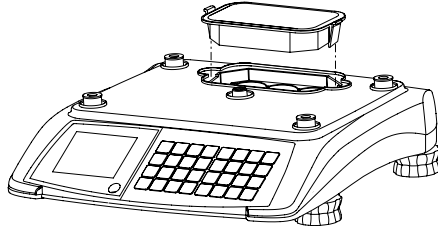

1. Make sure that the external power supply is disconnected.
2. Remove the weighing pan.
3. Remove the battery compartment cover.



#### WARNING

Damage to the battery if it is incorrectly installed.

- ▶ Pay attention to the correct battery polarity.  
If the positive pole (+) and the negative pole (–) are connected wrongly, the display will show "-----".  
After six seconds warning alarm, the scale will turn off automatically.
  - ▶ **Only use original manufacturer batteries.**
4. Place the battery in the compartment so that the terminal ends face upwards.
  5. Connect the red terminal end to the positive pole (red or +) and the black terminal end to the negative pole (black or –).
  6. Close the battery compartment.
  7. Put the weighing pan back on.



- The battery life is affected by charging and discharging conditions.
- If correctly used, the battery life can reach approx. 300 charging cycles.
- The battery's operating time is reduced when the battery has not been used over a longer period of time (two months).
- It is recommended that the battery be charged at least every 3 months.
- If the battery was not used over a longer period of time, then charge the battery at least three times and use it until it is completely discharged.
- The charging time decreases if the battery is not fully discharged.
- 6V Lead Acid batteries

## 2.5 Connecting to mains power

The power supply is stored in a department under the scale to support save transport.

1. Connect the supplied power supply unit to the power connection socket on the underside of the scale.
2. Plug the power supply unit into a correctly grounded power outlet.

## 2.6 Turning scale on/off

- ▶ To turn the scale on press the **On/Off** key.
- ▶ To turn the scale off press and hold the **On/Off** key until a long beep can be heard.



- After the scale is turned on, it runs through a short display test. All segments and status messages briefly light up, the software version is displayed.
- The scale is ready when the weight display appears.

## 2.7

### Cleaning



#### CAUTION

##### Damage to the scale

- ▶ Turn off and unplug the device before cleaning.
- ▶ Do not open the device.
- ▶ Make sure that no fluids get inside the device.
- ▶ Do not use scouring powders or plastic dissolving cleaning agents for cleaning.

##### Cleaning

- ▶ Remove the weighing pan and clean it with a commercially available household detergent.
- ▶ If heavily soiled, clean the surface of the device with a damp cloth that has been dipped in water containing a mild liquid detergent and well wrung out.

## 3 Operation

### 3.1



0 ... 9

#### Free input

You can immediately use your scale for weighing and selling – without prior configuration.

1. Place the item on the scale.
2. Enter the unit price (price/kg).  
The price to pay is displayed.
3. Remove the item from the scale.  
All displays return to 0.



Enter the unit price as usual without the decimal point, but with all the decimal places.

### 3.2

#### Working with PLUs

You can save the price for frequently sold goods in the scale's PLU memory and simply call it up later.

#### 3.2.1

##### Creating a PLU

0 ... 9

PLU



P

0 ... 9



1. Enter the unit price (price/kg).
2. Press and hold the **PLU** key until a long beep can be heard.  
P appears in the weight display.
3. Enter the PLU number (between 1 and 9999).
4. Wait until the scale beeps twice.  
The PLU is stored and all displays return to 0.



The scale can store 50 PLUs. If the memory is full and you want to store a new PLU the messages "Full" and "Delete" are displayed. You can either overwrite a specific PLU or delete the whole PLU memory.

- To overwrite an existing PLU press the **C** key and create a new PLU with the number you want to overwrite.
- To delete the whole PLU memory press the **Enter** (On/Off) key.

### 3.2.2

#### Calling up PLUs

Depending on the setting of operator setup Step 7, there are two ways to call up PLUs.



0 ... 9 **PLU**

#### Calling up via PLU key (factory setting, operator setup Step 7 = OFF)

1. Place the item on the scale.
2. Enter the corresponding PLU number and press the **PLU** key. Unit price and price to pay are displayed.
3. Remove the item from the scale. All displays return to 0.



0 ... 9

#### Calling up PLU automatically (operator setup Step 7 = ON)

1. Place the item on the scale.
2. Enter the corresponding PLU number. The PLU is called up automatically. Unit price and price to pay are displayed.
3. Remove the item from the scale. All displays return to 0.

### 3.2.3

#### Using PLU preset keys

You can save the most important PLUs to the keys in the left-hand key field.

0 ... 9

**M1**



#### Storing a PLU to a preset key

1. Enter the unit price (price/kg) or recall PLU.
2. Press and hold the desired preset key, e.g., **M1**, until a long beep can be heard. Two short beeps indicate that the data has been stored.



**M1**

### Calling up PLUs with preset keys

1. Place the item on the scale.
2. Press the corresponding preset key, e.g., **M1**.  
Unit price and price to pay are displayed.
3. Remove the item from the scale.  
All displays return to 0.

## 3.3

### Using tare

You fill containers with your products or customers bring their own container. The tare function makes sure that only the goods are entered and paid.

If you know the weight of your containers, you can enter the tare weight via keyboard. So you do not have to tare the empty container.



...

### Taring an empty container

1. Place the empty container on the scale.
2. Press the **Tare** key.  
The weight display is reset to 0.000 kg and the NET symbol appears. The tare weight is displayed with negative sign in the first line of the display when the empty container is removed from the scale.
3. Fill the container with the goods to be weighed.
4. Carry out pricing as described above.
5. Remove the container from the scale.  
All displays return to 0.

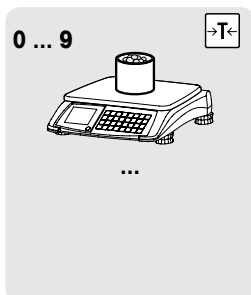

### Keyboard tare

1. Input the known tare value and press the **Tare** key.
2. Place the item with container or wrapping material onto the scale.
3. Carry out pricing as described above.
4. Remove the item with container or wrapping material from the scale.  
All displays return to 0.

### 3.4

#### Zeroing

Due to soiling on the weighing pan or unfavourable external influences, it is possible that the weight display of an unloaded weighing pan may no longer be 0.000 kg. In such cases, the scale must be reset to zero. The maximum allowed deviation to be compensated by zeroing is +/- 2 % of the weighing range.

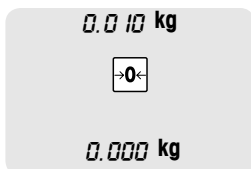

- Press the **Zero** key.

The weight display is set to zero.

### 3.5

#### By-count operation

With the by-count function, you can price non-weighing items, e.g., in the bakery department.

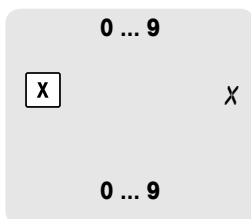

1. Enter the unit price.
2. Press the **X** key to call up the by-count function.  
The by-count icon is displayed.
3. Enter the number of items (1 ... 99).  
The price to pay is displayed.



- The unit price is stored until by-count operation is ended.
- Use the **C** key to leave by-count operation.

### By-count operation (US version)

With the by-count function, you can price non-weighing items, e.g., in the bakery department. Pricing can base on a deal quantity of, e.g., 3 pieces.

1. Enter the deal quantity (1 ... 99).
2. Press the **X** key to call up the by-count function.  
The by-count icon is displayed.
3. Enter the price per deal quantity.
4. Confirm with the **Enter** (On/Off) key.
5. Enter the number of items (1 ... 99).  
The price to pay is displayed.

0 ... 9

X

X

0 ... 9



0 ... 9



- The unit price is stored until by-count operation is ended.
- Use the **C** key to leave by-count operation.

### 3.6

### Accumulating

This functionality is only legal in certain regions.

1. Place the first item on the scale.
2. Carry out pricing as described above.
3. Press the **Enter** (On/Off) key.  
The total price to pay and the number of items is displayed.
4. Remove the item and press the **Enter** (On/Off) key again.  
The weight display is shown.
5. Repeat steps 1 to 4 for more items.
6. To finish the transaction, press the **Enter** (On/Off) key.  
The total price to pay and the number of items is displayed.
7. To clear the total, press and hold the **C** key.  
The total is cleared



...



total  
i



...



total  
5



**3.7****Change function**

Your scale is able to calculate the amount of change.

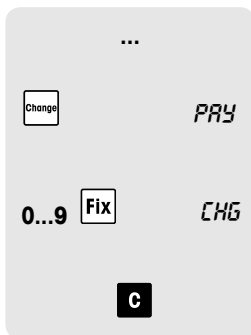
**Single item**

1. Carry out pricing as described above.
2. Press the **Change** key.  
The total price to pay is displayed.
3. Enter the customer's payment and press the **FIX** key.  
The amount of change is displayed.
4. Press the **C** key to return to normal weighing mode.

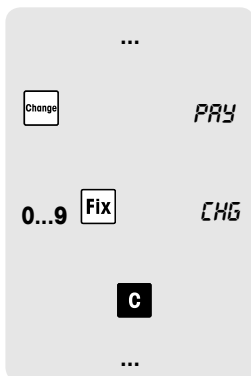
**Multiple items**

1. Carry out accumulating as described above.
2. When the total is displayed press the **Change** key.  
The total price to pay is displayed.
3. Enter the customer's payment and press the **FIX** key.  
The amount of change is displayed.
4. Press the **C** key to finish the change function.
5. Clear total as described above.



### 3.8

#### Fix unit price and/or tare

In normal operation, unit price and tare weight – if applicable – are cleared when the item is removed from the scale.

For weighing and pricing, several samples of the same PLU, e.g., for repackaging or sweet sales, you can fix unit price and/or tare.

#### Fixing price and tare weight

1. Tare the container as described above.
2. Place the first sample on the scale.
3. Carry out pricing as described above.
4. Press the **FIX** key.

When removing the item from the scale, the unit price and tare are still displayed.

5. Place the next sample on the scale.  
The price to pay is displayed.
6. Remove the item from the scale.
7. Repeat steps 5 and 6 for more samples of the same unit price and tare.
8. Press the **FIX** key again to return to normal weighing mode.



...

**Fix**



3.99 E/KG



8.75 E

...

**Fix**



- To fix the price only, just begin with step 2
- To fix the tare weight only, just leave out steps 2 and 3

**3.9****Hold function**

When using the hold function, the price to pay is kept in the display when the item is removed from the scale.

1. Place the item on the scale.
2. Carry out pricing as described above.
3. Press and hold the **Hold** (FIX) key until a long beep can be heard. Weight and unit price are cleared, the price to pay and "Hold" are displayed.
4. When removing the item from the scale, the price to pay is still displayed.
5. To return to normal weighing mode, press and hold the **Hold** key again until a long beep can be heard.

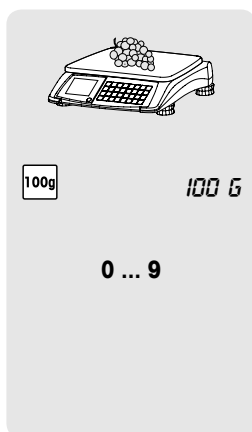
**3.10****Weighing with 100 g (1/2 lb / 1/4 lb) price unit**

For many products, customers are used to a price per 100 g (1/2 lb / 1/4 lb).

This function is only available if permitted by the national W & M regulations.

1. Place the item on the scale.
2. Press the **100 g** (1/2 lb / 1/4 lb) key.  
The icon 100 g (1/2 lb / 1/4 lb) is displayed.
3. Enter the unit price per 100 g (1/2 lb / 1/4 lb).  
The unit price per 100 g (1/2 lb / 1/4 lb) and the price to pay are displayed.
4. Remove the item from the scale.  
All displays return to 0.



100 g (1/2 lb / 1/4 lb) mode stays active until the **100 g** (1/2 lb / 1/4 lb) key is pressed again.

### 3.11

#### Switching weighing unit between kg and lb

This function is only available if permitted by the national W & M regulations.

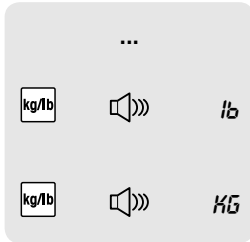

1. Carry out pricing as described above.
2. Press the **Units** key until a long beep is can be heard. The weight is displayed in the second weight unit.
3. Press the **Units** key again until a long beep can be heard to return to the first weight unit.

### 3.12

#### Displaying the price to pay in EURO

Depending on the setting of operator setup Step 10, the price to pay can be converted, e.g., from EURO to the old local currency. This function is only available if permitted by the national W & M regulations.

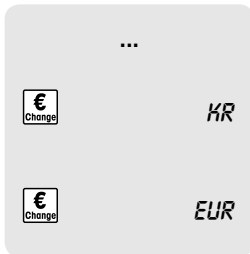

1. Carry out pricing as described above.
2. Press the **EUR** key. The price to pay is displayed in the second currency.
3. Press the **EUR** key again to return to the first currency.

### 3.13

#### Backlight function

If the light of the environment is not bright enough to get a clear reading from the display, the backlight can be switched on.

#### Switching backlight on/off



- ▶ Press and hold the **C** key until a long beep can be heard. The backlight is switched on/off.



When the scale is not used for 15 seconds, the backlight automatically switches off. When a weight is placed on the scale or when a key is pressed, the backlight switches on again.

## 4 Operator setup

### 4.1 Setup operation

#### 4.1.1 Entering operator setup

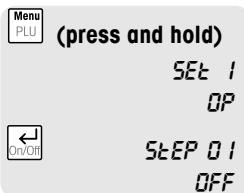

1. Press and hold the **Menu** (PLU) key until a long beep can be heard. SET 1 OP is displayed for "Operator Setup"
2. Press the **Enter** (On/Off) key to enter operator configuration. The first operator setup step and its current setting are displayed.

#### 4.1.2 Navigation in the setup

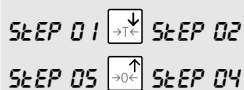

#### Selecting setup step

- To move to another setup step, use the **Arrow down** (Tare) key or **Arrow up** (Zero) key. In the line below, the current setting of the step is displayed.



#### Changing settings

- To toggle between the settings of a setup step, use the **Enter** (On/Off) key. When moving to another setup step, the selected setting is confirmed.

#### 4.1.3 Ending setup

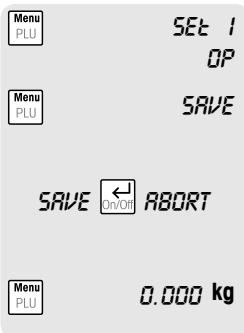

1. Press the **Menu** (PLU) key to leave operator setup steps.
2. Press the **Menu** (PLU) key again to leave the setup mode. SAVE is displayed.
3. If you do not want to save, use the **Enter** (On/Off) key to toggle between SAVE and ABORT.
4. Press the **Menu** (PLU) key a third time to return to the weighing mode.

#### 4.1.4

#### Example: Setting digital filter to low (operator setup Step 8 = 0)

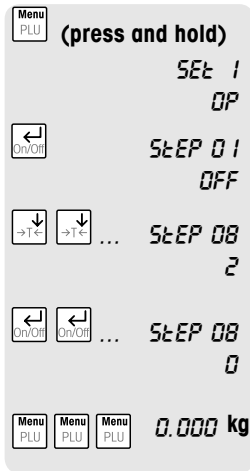

1. Press and hold the **Menu** (PLU) key until a long beep can be heard. SET 1 OP is displayed for "Operator Setup".
2. Press the **Enter** (On/Off) key to enter operator configuration. The first operator setup step and its current setting are displayed.
3. To move to setup Step 8, press the **Arrow down** (Tare) key repeatedly until Step 08 with its current setting is displayed.
4. To change the setting of setup Step 8, press the **Enter** (On/Off) key repeatedly until the setting is 0.
5. End setup by pressing the **Menu** (PLU) key three times.

#### 4.2

#### Operator setup overview

Factory settings are indicated in **bold** print.

No.	Setting	Description
<b>1</b>	<b>Reset</b>	<p>ON Reset operator setup functions to factory settings</p> <p><b>OFF</b> Do not reset operator setup functions</p>
<b>2</b>	<b>Beeper</b>	<p>ON Beep when a key is pressed</p> <p>OFF No sound when a key is pressed</p>
<b>3</b>	<b>Backlighting</b>	<p>ON Backlighting on</p> <p><b>OFF</b> Backlighting off</p>
<b>4</b>	<b>Power off / sleep</b>	<p>0 Both disabled, power off and sleep function</p> <p>1 No sleep funktion, automatic power off after 30 minutes of non-use</p> <p>2 Sleep funktion after 5 minutes of non-use, no automatic power off</p> <p>3 Sleep funktion after 5 minutes of non-use, automatic power off after 30 minutes of non-use</p> <p>4 Sleep funktion after 15 minutes of non-use, no automatic power off</p> <p><b>5</b> Sleep funktion after 15 minutes of non-use, automatic power off after 30 minutes of non-use</p>

#### 1 Reset

- ON Reset operator setup functions to factory settings
- OFF** Do not reset operator setup functions

#### 2 Beeper

- ON Beep when a key is pressed
- OFF No sound when a key is pressed

#### 3 Backlighting

- ON Backlighting on
- OFF** Backlighting off

#### 4 Power off / sleep

- 0 Both disabled, power off and sleep function
- 1 No sleep funktion,  
automatic power off after 30 minutes of non-use
- 2 Sleep funktion after 5 minutes of non-use,  
no automatic power off
- 3 Sleep funktion after 5 minutes of non-use,  
automatic power off after 30 minutes of non-use
- 4 Sleep funktion after 15 minutes of non-use,  
no automatic power off
- 5** Sleep funktion after 15 minutes of non-use,  
automatic power off after 30 minutes of non-use

No.	Setting	Description
<b>5</b>	<b>Auto clear tare</b>	
	<b>ON</b>	Automatic clearing of the tare weight when the load is removed from the platform
	<b>OFF</b>	No automatic clearing of the tare weight
<b>6</b>	<b>Prepack / fix mode</b>	
	<b>ON</b>	Prepack / fix mode enabled
	<b>OFF</b>	Prepack / fix mode disabled
<b>7</b>	<b>Auto PLU</b>	
	<b>ON</b>	Find PLU as soon as a number is entered
	<b>OFF</b>	Find PLU after pressing the PLU key
<b>8</b>	<b>Digital filter</b>	
	<b>0</b>	Low digital filtering
	<b>1</b>	Medium digital filtering
	<b>2</b>	High digital filtering
<b>9</b>	<b>Charging function</b>	
	<b>ON</b>	Battery charging function enabled
	<b>OFF</b>	Battery charging function disabled To change charging function you are asked to enter a password: 55555
<b>10</b>	<b>Function keys</b>	
	<b>0</b>	Function keys disabled
	<b>1</b>	Function keys enabled
<b>11</b>	<b>PLU</b>	
	<b>ON</b>	Storing PLUs enabled
	<b>OFF</b>	Storing PLUs disabled
<b>12</b>	<b>By-count operation</b>	
	<b>ON</b>	By-count operation enabled
	<b>OFF</b>	By-count operation disabled
<b>13</b>	<b>Euro</b>	
	<b>1</b>	Only the local currency is displayed
	<b>2</b>	You are asked to enter the conversion rate from the local currency into EUR. When pressing the EUR key, the local currency is converted into EUR.
	<b>3</b>	You are asked to enter the conversion rate from EUR into the local currency. When pressing the EUR key, EUR is converted into the local currency.
	<b>4</b>	Only EUR is displayed.

## 5 What do you do if....?

### General

If the scale shows an error message, proceed as follows:

1. Turn off the scale and wait for approx. 5 seconds.
2. Turn on the scale.
3. If the error message is still displayed, refer to the error message list.

### Error message list

Error	Cause	Remedy
E11	RAM error	▶ Call service technician
E16	ROM error	▶ Call service technician
E18	EEPROM error	▶ Call service technician
E34	PLU No. too high	▶ Enter PLU No. from 1 to 99
No PLU	PLU not found	▶ Store PLU
nnnnnn	Overload	▶ Reduce load
uuuuuu	Load too small	▶ Re-zero the scale

## 6 Technical data and accessories

### 6.1 Technical data

#### Display

Weight display	6 digits
Unit price display	6 digits
Total price display	6 digits

#### Ambient conditions

Operating temperature	-10 °C to +40 °C
Storage temperature	-25 °C to +50 °C

#### Electrical data

Power supply	12 V DC
Power consumption	50 mA
Plug-in adapter	In: 230 V AC 50 Hz Out: 12 V DC / 800 mA
Charging current	500 mA
Lead acid battery	6 V, 4.5 Ah

### 6.2 Accessories

The following optional accessories are available from your sales representative:

- Weighing platform cover
- Scale cover
- Deep bowl
- Lead acid battery



The offering of accessories may vary by the region.



### 6.3

### Compliance



Compliance to the following standards is indicated by the corresponding mark on the product.

This product conforms to the EMC directive 2014/30/EU, the Low Voltage Directive 2014/35/EU and the Non-automatic Weighing Instruments Directive 2014/31/EU. The complete Declaration of Conformity is available online at

<http://www.mt.com/retail-manuals>

# 7 Appendix

## 7.1 Periodical verification in the countries of the EEC

Country	Period	Date on seal	Verification body	Note
Austria	2 years	Year	MT	W&M if no private body accredited
Belgium	4 years	Year	W&M	
Bulgaria	1 year class III	Month	W&M	
Croatia	1 year	Quarter	W&M	
Czech Republic	2 years	Year	W&M	
Denmark	4 years	Year	Force, MT	MT as of 2009
Estonia	1 year	Month	Metroserf	
Finland	3 years	Year	W&M	
France	2 years	Month	MT	
Germany	2 years	Year	W&M	
Greece	1 year	Year	W&M	
Hungary	2 years	Exact day	W&M	
Iceland	2 years	Year	W&M	
Ireland	1 year	Exact day	W&M	
Italy	3 years	Month	MT	
Latvia	2 years	Year	W&M	
Lithuania	2 years	Year	W&M	
Netherlands	None	–	MT	
Norway	3 years	Year	W&M	
Poland	4 years / 25 months	Year / Month	W&M	4 years after initialisation, 25 months on periodic
Portugal	1 year	Year	W&M	
Romania	1 year	Month	W&M	
Slovakia	2 years	Exact day	W&M	
Slovenia	2 years	Exact day	W&M	
Spain	2 years	Year	W&M	
Sweden	2 (1) years	Year	W&M	1 year when used outdoors
Switzerland	2 years	Year	W&M	
United Kingdom	None	–	W&M	

## 7.2



### Disposal

In accordance with the requirements of European Directive 2002/96 EC on Waste Electrical and Electronic Equipment (WEEE), this device may not be disposed of with domestic refuse. This also applies for countries outside the EU in accordance with their respective national regulations.

- ▶ Please dispose of this product in accordance with local regulations for the separate collection of waste electrical and electronic equipment.

Should you have any questions, please contact the corresponding authorities or the dealer from whom this device was purchased.

If this device is passed on (for example for further private or commercial/ industrial use), this regulation is also to be passed on.

Many thanks for your contribution to the protection of the environment.

**Battery disposal** Batteries contain heavy metals and therefore cannot be disposed of in the domestic refuse.

- ▶ Observe local regulations on the disposal of materials which are hazardous to the environment.

[www.mt.com/retail](http://www.mt.com/retail)

For more information

**Mettler-Toledo GmbH**

Im Langacher 44  
8606 Greifensee, Switzerland  
[www.mt.com/contact](http://www.mt.com/contact)

Subject to technical changes.  
© Mettler-Toledo GmbH 08/16  
30209968C en

