





# METTLER TOLEDO Service

Congratulations on choosing the quality and precision of METTLER TOLEDO. Proper use of your new equipment according to this Manual and regular calibration and maintenance by our factory-trained service team ensures dependable and accurate operation, protecting your investment. Contact us about a service agreement tailored to your needs and budget. Further information is available at ► [www.mt.com/service](http://www.mt.com/service).

There are several important ways to ensure you maximize the performance of your investment:

- 1 **Register your product:** We invite you to register your product at [www.mt.com/productregistration](http://www.mt.com/productregistration) so we will provide you with information tailored to your specific needs. Additionally, you will receive promotions that you as a METTLER TOLEDO product owner can benefit from at your convenience.
- 2 **Contact METTLER TOLEDO for service:** The value of a measurement is proportional to its accuracy – an out of specification scale can diminish quality, reduce profits and increase liability. Timely service from METTLER TOLEDO will ensure accuracy and optimize uptime and equipment life.
  - ➔ **Installation, Configuration, Integration and Training:** Our service representatives are factory-trained weighing equipment experts. We make certain that your weighing equipment is ready for production in a cost effective and timely fashion and that personnel are trained for success.
  - ➔ **Initial Calibration Documentation:** The installation environment and application requirements are unique for every industrial scale so performance must be tested and certified. Our calibration services and certificates document accuracy to ensure production quality and provide a quality system record of performance.
  - ➔ **Periodic Calibration Maintenance:** A Calibration Service Agreement provides on-going confidence in your weighing process and documentation of compliance with requirements. We offer a variety of service plans that are scheduled to meet your needs and designed to fit your budget.

## Safety Instructions

- Read this manual BEFORE operating or servicing this equipment and FOLLOW these instructions carefully.
- SAVE this manual for future reference.

### Safety Instructions for Installation



#### **WARNING**

Do not install or perform any service on this equipment before the area in which the equipment is located has been secured as nonhazardous by personnel authorized to do so by the responsible person at the customer's site.



#### **WARNING**

Only permit qualified personnel to service the equipment. Exercise care when making checks, tests and adjustments that must be made with power on. Failure to observe this precaution could result in bodily harm and/ or property damage.



#### **WARNING**

Refer to the data plate of the equipment to determine if it is approved for use in an area classified as hazardous because of combustible or explosive atmospheres.



#### **WARNING**

All equipment must be installed in accordance with the installation instructions and Control Drawing 30595335 detailed in this manual respectively in the manufacturer manuals of the associated apparatus. Be careful to study and follow the guidance (general notes and application specific notes) in the Control Drawing 30595335. Deviation from the instructions can impair the intrinsic safety of the equipment and void the agency approval.



#### **WARNING**

Install cable seal between differently rated areas per country-specific regulations. For details, refer to Control Drawing 30595335.



#### **WARNING**

For continued protection against shock hazard, connect to properly grounded power source only. Do not remove the grounding connection.



#### **WARNING**

Ensure proper equipotential grounding of the equipment, mounting accessories, and the scale base.





**⚠ WARNING**

Be certain that the communication circuits are wired exactly as shown in the installation section of its corresponding user manual. If the wires are not connected correctly, the equipment or interface board may be damaged.



**⚠ WARNING**

The mains connection of the power supply unit must be made by a professional electrician authorized by the owner and in accordance with the respective terminal diagram, the accompanying installation instructions as well as the country-specific regulations.



**⚠ WARNING**

The explosion-protected weighing system must be checked to ensure compliance with the requirements for safety before being put into service for the first time, following any service work and every 3 years, at least.

**Safety Instructions for Operation and Maintenance**



**⚠ WARNING**

Do not open when an explosive atmosphere is present.



**⚠ WARNING**

Avoid damage to the system components. If danger occurs, immediately put the system out of operation. Immediately replace damaged system components, repaired by authorized service personnel.



**⚠ WARNING**

Avoid plastic covers over the equipment. Wear suitable clothing. Avoid nylon, polyester or other synthetic materials that generate and hold charge. Use conductive footwear and flooring.



**⚠ WARNING**

If the keyboard, display lens or enclosure is damaged, the defective component must be repaired immediately. Remove power immediately and do not reapply power until the display lens, keyboard or enclosure has been repaired or replaced by qualified service personnel. Failure to do so could result in bodily harm and/or property damage.



**⚠ WARNING**

Operation is only permitted when operational and process-related electrostatic charges are eliminated. Use the equipment only when electrostatic processes leading to propagation brush discharge is impossible. Keep the equipment away from processes that generate high charging potential such as electrostatic coating, rapid transfer of non-conductive materials, rapid air jets, and high pressure aerosols.

**Special Conditions for Safe Use**



**⚠ WARNING**

The non-metallic parts (display area of IND500x) incorporated in the enclosure of this equipment may generate an ignition-capable level of electrostatic charge.

- 1 The equipment shall not be installed in a location where build-up of electrostatic charge on such surfaces shall occur.
- 2 The display area of the equipment shall only be gently cleaned with a damp cloth.
- 3 Strong solvents are not allowed to be used for cleaning of the whole ESD protected plastic keypad.
- 4 The entire plastic keypad must be replaced when the ESD protection layer is visibly worn.



**⚠ WARNING**

The Model IND500x Weighing Indicator circuits shall be limited to overvoltage category I or II as defined in IEC 60664-1.



**⚠ WARNING**

The Model IND500x Weighing Indicator shall not be used where UV light or radiation may impinge on the enclosure.

**Safety Instructions for Service**



**⚠ WARNING**

Only permit qualified personnel to service the equipment. Exercise care when making checks, tests and adjustments that must be made with power on. Failure to observe this precaution could result in bodily harm and/ or property damage.



**⚠ WARNING**

Do not perform any service on this equipment before the area in which the equipment is located has been secured as nonhazardous by personnel authorized to do so by the responsible person at the customer's site.



### **WARNING**

Only the components specified in the user manual can be used in this device. All equipment must be installed in accordance with the installation instructions detailed in the user manual. Incorrect or substitute components and/or deviation from these instructions can impair the intrinsic safety of the equipment and could result in bodily injury and/or property damage.



### **WARNING**

To prevent ignition of hazardous atmospheres, disconnect the equipment from its power source before opening the enclosure. Keep cover tightly closed while the circuit is energized. Do not open when an explosive dust atmosphere is present.



### **WARNING**

Before connecting/disconnecting any internal electronic components or inter-connecting wiring between electronic equipment always remove power and wait at least thirty (30) seconds before any connections or disconnections are made. Failure to observe these precautions could result in damage to or destruction of the equipment and/or bodily harm.



### **WARNING**

The explosion-protected weighing system must be checked to ensure compliance with the requirements for safety before being put into service for the first time, following any service work and every 3 years, at least.



### **WARNING**

Observe precautions for handling electrostatic sensitive devices.

## Disposal of Electrical and Electronic Equipment

In conformance with the European Directive 2012/19/EU on Waste Electrical and Electronic Equipment (WEEE) this device may not be disposed of in domestic waste. This also applies to countries outside the EU, per their specific requirements.

Please dispose of this product in accordance with local regulations at the collecting point specified for electrical and electronic equipment. If you have any questions, please contact the responsible authority or the distributor from which you purchased this device. Should this device be passed on to other parties, the content of this regulation must also be related.





# Table of Contents

<b>1</b>	<b>Introduction</b>	<b>11</b>
1.1	IND500x Overview .....	11
1.2	IND500x Features .....	11
1.3	Operating Environment.....	12
1.3.1	Temperature and Humidity .....	12
1.3.2	Environmental Protection .....	12
1.3.3	Hazardous Areas .....	12
1.4	Inspection and Contents Checklist .....	12
1.5	Physical Dimensions .....	12
1.5.1	Harsh Enclosure .....	13
1.6	Specifications .....	14
1.7	Main PCB.....	16
1.8	Communication Board Options .....	17
1.9	Configuration.....	18
1.9.1	System Configuration .....	18
1.9.2	Connections .....	19
1.10	Manufacturing Date .....	20
1.11	Compliance Information .....	20
<b>2</b>	<b>Operation</b>	<b>21</b>
2.1	User Security.....	21
2.1.1	Accessing Setup and Terminal Functions .....	21
2.1.2	Metrology Switch .....	22
2.2	Terminal Operation .....	23
2.3	Understanding the HMI (Human Machine Interface).....	23
2.3.1	Navigation Keys .....	24
2.3.1.1	UP and DOWN Navigation Keys .....	24
2.3.1.2	LEFT and RIGHT Navigation Keys.....	25
2.3.1.3	ENTER Key.....	25
2.3.2	Softkeys and Icons .....	25
2.3.3	Scale Function Keys .....	28
2.3.4	Alphanumeric Keys .....	29
2.4	Data Entry .....	30
2.4.1	Data Entry Modes .....	30
2.4.1.1	Numeric Entry.....	30
2.4.1.2	Upper- and Lower-Case Alpha Entry .....	30
2.4.2	Special Symbols and Punctuation Entry .....	30
2.4.3	Global Character Entry.....	31
2.5	Home Screen .....	32
2.6	Basic Functionality .....	32
2.6.1	Zero .....	33
2.6.1.1	Automatic Zero Maintenance .....	33
2.6.1.2	Power-Up Zero.....	33
2.6.1.3	Pushbutton Zero .....	33
2.6.1.4	Timed Zero .....	33
2.6.2	Tare .....	34
2.6.2.1	Pushbutton Tare .....	34
2.6.2.2	Keyboard Tare .....	34
2.6.2.3	Special Tare Operation in Multi-interval Scale Applications .....	35
2.6.2.4	Tare Table.....	35
2.6.2.5	Loading Records from the Tare Table .....	36
2.6.2.6	Net Sign Correction .....	36
2.6.2.7	Auto Tare .....	37
2.6.2.8	Clearing Tare.....	37
2.6.2.8.1	Manual Clear .....	37
2.6.2.8.2	Auto Clear .....	37
2.6.3	Printing.....	38
2.6.3.1	Enabling Printing .....	38
2.6.3.2	Print Interlock .....	38

2.6.3.3	Automatic Print .....	38
2.6.3.4	Repeat Printing .....	38
2.6.3.5	Custom Print Trigger.....	38
2.6.3.6	Report Printing.....	38
2.6.4	Totalization .....	39
2.6.4.1	Transaction Counter .....	39
2.6.4.2	Grand Total and Subtotal .....	39
2.6.4.3	Totals Recall .....	39
2.6.5	Unit Switching .....	39
2.6.6	Expand By 10 .....	39
2.6.7	Calibration Management.....	40
2.6.7.1	Service Triggers .....	40
2.6.7.2	Service Notification.....	40
2.6.8	MinWeigh .....	41
2.6.9	CalFree™ .....	41
2.6.10	Time and Date.....	41
2.6.11	ID .....	42
2.6.12	Target Comparison.....	42
2.6.12.1	Application Entry.....	43
2.6.12.2	Manual Filling .....	43
2.6.12.2.1	Start Filling with Active Target .....	45
2.6.12.2.2	Configure the Target Table .....	46
2.6.12.2.3	Configure Discrete I/O.....	48
2.6.12.3	Over/Under.....	49
2.6.12.3.1	Start Filling with Active Target .....	49
2.6.12.3.2	Configure the Target Table .....	50
2.6.12.3.3	Configure Target Operation.....	52
2.6.12.3.4	Configure Discrete I/O.....	53
2.6.13	SmartTrac™.....	54
2.6.14	Comparators .....	55
2.6.15	Alibi Memory Direct Access .....	56
2.6.15.1	Creating Alibi Memory Record.....	56
2.6.15.2	View and Print Alibi Memory.....	56
2.7	Information Recall .....	57

<b>3</b>	<b>Setup and Configuration</b> .....	<b>60</b>
3.1	Entering Setup Mode.....	60
3.1.1	To Enter a Username and a Password .....	60
3.2	Exiting Setup Mode.....	60
3.3	Logout .....	60
3.4	Setup Menu Tree .....	61
3.4.1	Setup Screens.....	62
3.4.1.1	Navigation .....	62
3.4.1.2	Data Entry.....	62
3.4.1.2.1	To Change the Field Value in a Selection Box .....	62
3.4.1.2.2	To Change the Field Value Using Alphanumeric Characters .....	63
3.5	Overview of Configuration.....	63
3.6	Scale .....	63
3.6.1	Scale - Analog.....	64
3.6.1.1	Scale Type .....	64
3.6.1.1.1	Name.....	64
3.6.1.1.2	Scale Type .....	64
3.6.1.1.3	Approval.....	64
3.6.1.1.4	Class .....	65
3.6.1.1.5	Verified Interval.....	65
3.6.1.1.6	Power Up Delay.....	65
3.6.1.2	Capacity & Increment .....	66
3.6.1.2.1	Primary Units .....	66
3.6.1.2.2	# Ranges/Intervals.....	66
3.6.1.2.3	Blank Over Capacity.....	66
3.6.1.3	Calibration .....	67
3.6.1.3.1	Geo Code .....	67

3.6.1.3.2	Base Serial Number .....	67
3.6.1.3.3	Calibration Units .....	67
3.6.1.3.4	Linearity Adjustment .....	67
3.6.1.3.5	Calibration Softkeys .....	68
3.6.1.4	Zero .....	70
3.6.1.4.1	AZM & Display .....	70
3.6.1.4.2	Ranges.....	71
3.6.1.5	Tare .....	72
3.6.1.5.1	Tare Types .....	72
3.6.1.5.2	Auto Tare .....	73
3.6.1.5.3	Auto Clear .....	73
3.6.1.6	Units .....	74
3.6.1.6.1	Second Unit .....	74
3.6.1.6.2	Third Unit .....	74
3.6.1.6.3	Power Up.....	74
3.6.1.6.4	Custom Factor.....	74
3.6.1.6.5	Custom Name .....	75
3.6.1.6.6	Custom Increment.....	75
3.6.1.7	Rate .....	75
3.6.1.7.1	Weight Units .....	75
3.6.1.7.2	Time Units .....	75
3.6.1.7.3	Measurement Period .....	75
3.6.1.7.4	Output Average.....	75
3.6.1.8	Filter.....	75
3.6.1.8.1	Low Pass Frequency .....	75
3.6.1.8.2	Low Pass # of Poles .....	76
3.6.1.8.3	Notch Filter Frequency .....	76
3.6.1.8.4	Stability Filter.....	76
3.6.1.9	Stability .....	76
3.6.1.9.1	Motion Range.....	76
3.6.1.9.2	No-Motion Interval .....	76
3.6.1.9.3	Timeout .....	76
3.6.1.10	Log or Print .....	77
3.6.1.10.1	Minimum Weight .....	77
3.6.1.10.2	Interlock .....	77
3.6.1.10.3	Automatic .....	77
3.6.1.10.4	Reset On.....	77
3.6.1.10.5	Threshold Weight.....	77
3.6.1.10.6	Motion Check .....	77
3.6.1.11	MinWeigh .....	78
3.6.1.11.1	MinWeigh .....	78
3.6.1.11.2	MinWeigh Behavior.....	79
3.6.1.12	Reset.....	80
3.6.1.12.1	Initiate Reset .....	80
3.6.2	Scale - IDNet .....	81
3.6.2.1	Scale Type .....	81
3.6.2.1.1	Name.....	81
3.6.2.1.2	Scale Type .....	81
3.6.2.1.3	Class .....	81
3.6.2.1.4	Verified Interval.....	81
3.6.2.2	Capacity & Increment .....	82
3.6.2.2.1	Primary Units .....	82
3.6.2.2.2	x10 Always.....	82
3.6.2.3	Calibration .....	82
3.6.2.3.1	Base Serial Number .....	82
3.6.2.3.2	Service Mode .....	82
3.6.2.4	Zero .....	82
3.6.2.4.1	AZM & Display .....	82
3.6.2.4.2	Ranges.....	83
3.6.2.5	Tare .....	83
3.6.2.5.1	Tare Types .....	83

3.6.2.5.2	Auto Tare .....	85
3.6.2.5.3	Auto Clear .....	85
3.6.2.6	Units .....	86
3.6.2.6.1	Second Unit .....	86
3.6.2.6.2	Third Unit .....	86
3.6.2.6.3	Power Up .....	86
3.6.2.6.4	Custom Factor .....	86
3.6.2.6.5	Custom Name .....	86
3.6.2.6.6	Custom Increment .....	86
3.6.2.7	Rate .....	86
3.6.2.7.1	Weight Units .....	87
3.6.2.7.2	Time Units .....	87
3.6.2.7.3	Measurement Period .....	87
3.6.2.7.4	Output Average .....	87
3.6.2.8	Filter .....	87
3.6.2.8.1	Vibration .....	87
3.6.2.8.2	Weighing Process .....	87
3.6.2.8.3	Update Rate .....	88
3.6.2.9	Stability .....	88
3.6.2.9.1	Stability .....	88
3.6.2.9.2	Timeout .....	88
3.6.2.10	Log or Print .....	88
3.6.2.10.1	Minimum Weight .....	89
3.6.2.10.2	Interlock .....	89
3.6.2.10.3	Automatic .....	89
3.6.2.10.4	Reset On .....	89
3.6.2.10.5	Threshold Weight .....	89
3.6.2.10.6	Motion Check .....	89
3.6.2.11	MinWeigh .....	89
3.6.2.11.1	MinWeigh .....	89
3.6.2.11.2	MinWeigh Behavior .....	90
3.6.2.12	Reset .....	91
3.6.2.12.1	Initiate Reset .....	92
3.6.3	Scale - SICSPRO .....	92
3.6.3.1	Scale Type .....	92
3.6.3.1.1	Name .....	92
3.6.3.1.2	Scale Type .....	92
3.6.3.1.3	Platform Serial Number .....	92
3.6.3.1.4	Approval .....	92
3.6.3.1.5	Class .....	93
3.6.3.1.6	Verified Interval .....	93
3.6.3.2	Advanced Setup Mode .....	93
3.6.3.3	Zero .....	93
3.6.3.3.1	Timed Zero .....	93
3.6.3.4	Units .....	94
3.6.3.4.1	Second Unit .....	94
3.6.3.4.2	Host/Auxillary Unit .....	94
3.6.3.4.3	Custom Factor .....	94
3.6.3.4.4	Custom Name .....	94
3.6.3.4.5	Custom Increment .....	94
3.6.3.5	Rate .....	94
3.6.3.5.1	Weight Units .....	94
3.6.3.5.2	Time Units .....	94
3.6.3.5.3	Measurement Period .....	94
3.6.3.5.4	Output Average .....	95
3.6.3.6	Stability .....	95
3.6.3.6.1	Timeout .....	95
3.6.3.7	Log or Print .....	95
3.6.3.7.1	Minimum Weight .....	95
3.6.3.7.2	Interlock .....	95
3.6.3.7.3	Automatic .....	95



3.6.3.7.4	Reset On.....	96
3.6.3.7.5	Threshold Weight.....	96
3.6.3.7.6	Motion Check.....	96
3.6.3.8	MinWeigh.....	96
3.6.3.8.1	MinWeigh.....	96
3.6.3.8.2	MinWeigh Behavior.....	97
3.6.3.9	Reset.....	98
3.6.3.9.1	Initiate Reset.....	98
3.7	Application.....	99
3.7.1	Memory.....	99
3.7.1.1	Alibi.....	99
3.7.1.1.1	View and Print Alibi Memory.....	99
3.7.1.2	Tare Table.....	100
3.7.1.2.1	View Tare Table Records.....	100
3.7.1.2.2	Edit or Add A Tare Table Record.....	101
3.7.1.3	Message Table.....	101
3.7.2	Operation.....	102
3.7.2.1	Comparators.....	102
3.7.2.2	Totalization.....	104
3.7.2.3	ID1, ID2, ID3 and ID4.....	105
3.7.3	Discrete I/O.....	107
3.7.3.1	Input.....	107
3.7.3.2	Output.....	108
3.7.4	TaskExpert.....	109
3.7.5	Reset.....	110
3.8	Terminal.....	110
3.8.1	Device.....	110
3.8.1.1	Terminal ID#1, ID#2, ID#3.....	110
3.8.1.2	Serial Number.....	110
3.8.1.3	Connected Devices.....	111
3.8.1.3.1	To Add or Modify Connected Device Records.....	111
3.8.1.3.2	To Delete or Clear Connected Device Records.....	111
3.8.2	Display.....	111
3.8.2.1	Backlight Timeout.....	111
3.8.2.2	Tare Display.....	111
3.8.2.3	Auxiliary Display.....	111
3.8.2.4	Metrology Line.....	112
3.8.2.5	Backlight Adjustment.....	112
3.8.3	Region.....	112
3.8.3.1	Format Time & Date.....	112
3.8.3.1.1	Time Format.....	112
3.8.3.1.2	Date Format.....	112
3.8.3.1.3	Date Field Separator.....	113
3.8.3.2	Set Time & Date.....	113
3.8.3.2.1	Hour.....	113
3.8.3.2.2	Minutes.....	113
3.8.3.2.3	Day.....	113
3.8.3.2.4	Month.....	113
3.8.3.2.5	Year.....	113
3.8.3.3	Language.....	113
3.8.3.3.1	Display Message.....	113
3.8.3.3.2	Keypad Selection.....	113
3.8.3.3.3	Print Comma/Decimal.....	114
3.8.3.3.4	Gross Legend.....	114
3.8.4	Transaction Counter.....	114
3.8.4.1	Transaction Counter.....	114
3.8.4.2	Counter Reset.....	114
3.8.4.3	Next Transaction.....	114
3.8.5	Users.....	114
3.8.5.1	To Enter A New Username and Password.....	114
3.8.5.2	To Modify and/or Enter A Password for A Username.....	115

3.8.5.3	Delete A User or Clear All Users.....	115
3.8.6	Auto Logout.....	115
3.8.7	Soffkeys.....	115
3.8.7.1	Editing Soffkeys.....	116
3.8.7.1.1	Inserting Soffkeys.....	117
3.8.7.1.2	Editing Soffkeys.....	117
3.8.7.1.3	Deleting Soffkeys.....	117
3.8.7.1.4	Clearing All Soffkeys.....	118
3.8.8	Reset.....	118
3.9	Communication.....	118
3.9.1	Security.....	118
3.9.1.1	Ethernet Security.....	118
3.9.2	Templates.....	119
3.9.2.1	Input.....	119
3.9.2.2	Output.....	120
3.9.2.2.1	Copy A Template.....	120
3.9.2.2.2	Clear A Template.....	120
3.9.2.2.3	View, Edit or Add A Template.....	121
3.9.2.3	Strings.....	124
3.9.3	Reports.....	125
3.9.3.1	Format.....	125
3.9.3.2	Tare Table.....	126
3.9.3.3	Target Table.....	126
3.9.4	Connections.....	127
3.9.4.1	COM4 and COM5.....	127
3.9.4.2	Reconnect Mode.....	128
3.9.4.3	Communication Port Assignment.....	128
3.9.4.4	Edit and Create Connection Assignments.....	129
3.9.5	Serial.....	131
3.9.5.1	COM1/COM2/COM3/COM4/COM5/COM6.....	131
3.9.6	Network.....	131
3.9.6.1	Ethernet.....	131
3.9.6.2	Port.....	132
3.9.6.2.1	Shared Data Server Port.....	132
3.9.6.2.2	Eprint Port.....	132
3.9.6.3	Print Client.....	132
3.9.7	PLC.....	132
3.9.7.1	Analog Output.....	132
3.9.7.2	Ethernet/IP.....	133
3.9.7.3	PROFIBUS-DP.....	134
3.9.7.4	PROFINET.....	134
3.9.7.5	Data Format.....	135
3.9.8	Reset.....	135
3.10	Maintenance.....	135
3.10.1	Configure / View.....	136
3.10.1.1	Change Log.....	136
3.10.1.2	Maintenance Log.....	136
3.10.1.3	Error Log.....	137
3.10.1.4	Calibration Management.....	138
3.10.1.5	Reset.....	139
3.10.2	Run.....	139
3.10.2.1	Diagostics.....	140
3.10.2.1.1	Display Test.....	140
3.10.2.1.2	Keyboard Test.....	140
3.10.2.1.3	Scale.....	140
3.10.2.1.4	Discrete I/O Test.....	141
3.10.2.1.5	Reset Flash 2.....	141
3.10.3	Reset All.....	141
<b>4</b>	<b>Maintenance and Service</b> .....	<b>143</b>
4.1	Terminal Cleaning and Maintenance.....	143
4.1.1	Overlay and Gasket.....	143

4.2	Service	143
4.2.1	General Safety Guidelines for Service	144
4.3	Upgrade the Firmware	144
4.3.1	Upgrade the Terminal Firmware	144
4.3.1.1	Perform the Terminal Firmware Upgrade with InSite CSL	144
4.3.2	Upgrade the SICSPRO Scale Firmware	145
4.3.2.1	Upload SICSPRO Scale Firmware	145
4.3.2.2	Install SICSPRO Scale Upgrade	146
4.4	Display Messages	148
4.4.1	Application Key Error	148
4.4.2	COM4 Error / COM5 Error	148
4.4.3	Invalid Parameters	149
4.5	Set A Custom Language	149
4.6	Error Management	149
4.6.1	Smart5® Introduction	149
4.6.1.1	Events and Alarms	149
4.6.1.2	NAMUR Alarm / Alert Classification	150
4.6.2	Error Log	151
4.6.3	Error Message	151
4.7	Troubleshooting	157
4.7.1	Power Test	157
4.7.1.1	Load Cell and IDNet/SICSPRO Power	158
4.7.2	Battery Test	158
4.7.3	Internal Diagnostic Testing	158
4.7.3.1	Display Test	159
4.7.3.2	Keyboard Test	159
4.7.3.3	Scale	159
4.7.3.3.1	Load Cell Output	159
4.7.3.3.2	Calibration Values	159
4.7.3.3.3	Statistics	159
4.7.3.4	Discrete I/O Test	159
4.7.4	Master Reset	159
4.8	External Diagnostics	160
4.8.1	Web Server	160
4.8.1.1	Home Page	160
4.8.1.2	Help File	161
4.8.1.3	Device	163
4.8.1.4	Scale	164
4.8.1.4.1	Statistics	164
4.8.1.4.2	Calibration Data	164
4.8.1.5	Terminal	166
4.8.1.5.1	Resource Utilization	166
4.8.1.5.2	Diagnostics	166
4.8.1.6	Communication	168
4.8.1.6.1	Service Alert	168
4.8.1.7	Maintenance	168
4.8.1.7.1	Write Shared Data	168
4.8.1.7.2	Read Shared Data	169
<b>5</b>	<b>Appendix</b>	<b>171</b>
5.1	Approvals	171
5.1.1	Testing Standards	171
5.1.1.1	CENELEC/ATEX	171
5.1.1.2	IECEX	171
5.1.1.3	FMus	171
5.1.1.4	cFM	171
5.1.1.5	UKEX Testing Standards	172
5.1.2	Understanding Approval Parameters	172
5.1.2.1	Entity Value Calculations	172
5.1.2.2	Fiber Optic Interface	172
5.1.3	United States Approvals	172
5.1.3.1	Special Conditions (FMus)	172

5.1.4	European ATEX and UKEX Approvals .....	173
5.1.4.1	Special Conditions (ATEX and UKEX) .....	173
5.1.5	Canadian Approvals .....	173
5.1.5.1	Special Conditions (FMca) .....	173
5.1.6	IECEX Approval .....	174
5.1.6.1	Special Conditions (IECEX) .....	174
5.1.7	FMus, FMc, ATEX, IECEX and UKEX Energy Limitation Parameters .....	174
5.1.8	Manufacturer Information .....	177
5.1.9	Importer Information .....	178
5.1.10	Marking Plate Example .....	178
5.2	Technical Data .....	178
5.2.1	Control Drawing .....	178
5.2.1.1	30595335A.pdf .....	179
5.3	Default Settings .....	194
5.4	Table and Log File Structure .....	198
5.4.1	Memory Tables .....	198
5.4.1.1	Alibi Memory .....	198
5.4.1.1.1	View Alibi Memory Records .....	199
5.4.1.2	Tare Table .....	199
5.4.1.3	Message Table .....	200
5.4.1.4	Target Table .....	200
5.4.1.4.1	Select A Target Record from list .....	201
5.4.1.4.2	Quick Access to A Target Record .....	201
5.4.1.4.3	Clear Totals .....	201
5.4.2	Log Files .....	202
5.4.2.1	Change Log .....	202
5.4.2.2	Maintenance Log .....	202
5.4.2.3	Error Log .....	203
5.5	Communications .....	204
5.5.1	Demand Output Mode .....	205
5.5.2	Custom Triggers .....	205
5.5.3	Output Templates .....	205
5.5.3.1	Template Example .....	206
5.5.4	Continuous Output Mode .....	207
5.5.4.1	Standard Continuous Output .....	207
5.5.4.2	Continuous Template Output .....	208
5.5.5	CTPZ .....	209
5.5.6	Standard Interface Command Set (SICS) Protocol .....	209
5.5.6.1	Data Interface Configuration .....	209
5.5.6.2	Version Number of the MT-SICS .....	209
5.5.6.3	Command Formats .....	209
5.5.6.4	Response Formats .....	210
5.5.6.5	Tips for the Programmer .....	211
5.5.6.6	Commands & Responses MT-SICS Level 0 .....	211
5.5.6.7	Commands & Responses MT-SICS Level 1 .....	215
5.5.7	Remote Discrete I/O (ARM100) .....	217
5.5.8	ASCII Input .....	217
5.5.9	Reports .....	218
5.5.9.1	Alibi Table .....	218
5.5.9.2	Tare Table Report .....	219
5.5.9.3	Target Table Report .....	219
5.5.9.4	Message Table Report .....	220
5.5.9.5	Totals Report .....	220
5.5.10	Shared Data Access .....	220
5.5.10.1	Shared Data Server Login .....	221
5.5.10.2	Shared Data Server Commands .....	222
5.5.10.3	Use Shared Data to Select Target Table and Tare Table Records .....	224
5.5.11	Ethernet .....	225
5.5.11.1	Ethernet Connection to A PC .....	225
5.5.11.1.1	IP Address Setup .....	226
5.5.11.2	Ethernet Demand Output .....	227

5.5.11.3	Ethernet Continuous Output .....	228
5.5.12	File Transfer .....	229
5.5.12.1	FTP Example .....	231
5.6	Metrological information.....	232
5.7	GEO Codes.....	232
5.8	ASCII Standard and Control Codes.....	234
5.8.1	Control Characters .....	236



# 1 Introduction

## 1.1 IND500x Overview

The IND500x represents the latest weighing technology from METTLER TOLEDO and is the most versatile weighing terminal for hazardous area Zone1/21 and Division 1 applications.

The IND500x terminal is a high-performance single- or multiple-range weighing terminal designed for use with analog load cells or high-precision IDNet and SICSpro scale interfaces. The IND500x delivers precision measurement data from milligrams to tons in a single cost effective package that easily integrates into existing systems.

IND500x is powered by an external power supply that converts high level AC voltage to intrinsically safe DC voltages and is still suitable for installation inside the hazardous area.

Enhanced PLC and PC communication interfaces are available through easy to install safe area communication modules. Internal and remote digital I/O options provide control for process applications such as filling. The versatile IND500x can be upgraded with a variety of special application software packages that add performance features where needed. These features make the IND500x the perfect match for nearly any weighing application in many industries, including:

- Pharmaceuticals
- Petrochemicals
- Refining
- Milling
- Agriculture
- Cosmetics and Fragrance
- Specialty Chemical
- Coatings and Inks

## 1.2 IND500x Features

- Basic weighing in hazardous (explosive) areas including zero, tare and printing
- Harsh desk/wall-mount enclosures
- Operates with the intrinsically safe APS768x
- Connect one analog load cell scale base (or up to four 350 ohm load cells), or an IDNet or SICSpro scale base
- 4.3" color display
- Real-time clock (battery backup)
- Electro-static discharge protected keypad
- Includes one standard intrinsically safe serial port (COM1) for asynchronous two-way communication and print output
- Includes standard intrinsically safe DI/Os (3 active inputs and 3 passive outputs)
- Support for the following internal option boards:
  - An additional intrinsically safe serial port
  - Intrinsically safe 4-20 mA analog output
  - Discrete I/O Interfaces
  - Dual channel intrinsically safe active current loop interface
  - Dual channel fiber optic interface
- Support for the following options utilizing the ACM500 communication module in the safe area:
  - Analog Output
  - EtherNet/IP
  - PROFIBUS® DP
  - Ethernet TCP/IP with two serial ports (Ethernet/COM2/COM3)
  - Modbus TCP
  - PROFINET®
- ID mode for prompted transaction sequencing
- Selectable Manual Filling mode for manual filling or dosing
- SmartTrac™ graphical display
- Unit switching between three different units, including custom units
- Alibi memory storage for up to 100,000 records
- Grand total and subtotal registers for accumulating weight

- Ten customizable print templates
- Report printing
- TraxDSP™ digital filtering for analog load cells
- TraxEMT™ performance monitoring and recording
- CalFREE™ calibration without test weights
- Support of the following Application Software Modules:
  - Manual formulation
  - Fill Pac
  - Task Expert™

### 1.3 Operating Environment

- Use the weighing terminal only when electrostatic processes leading to propagation brush discharge is impossible.
- Keep the terminal away from processes that generate high charging potential such as electrostatic coating, rapid transfer of non-conductive materials, rapid air jets, and high pressure aerosols.
- Choose a stable, vibration-free surface to mount the terminal.
- Ensure there are no excessive fluctuations in temperature and no direct exposure to sunlight.
- Avoid drafts on the weighing platform (for example, from open windows or air conditioning).
- Calibrate the terminal after any major change of geographical location.

#### 1.3.1 Temperature and Humidity

The terminal can be stored and operated at temperatures and relative humidity conditions as listed in [Specifications ▶ Page 14]

#### 1.3.2 Environmental Protection

The terminal has environment protection as listed in [Specifications ▶ Page 14].

#### 1.3.3 Hazardous Areas

The intrinsically safe IND500x terminal is designed to operate within an area classified as Division 1, Zone 1, or Zone 21.



#### **! WARNING**

**Refer to the data plate of the equipment to determine if it is approved for use in an area classified as hazardous because of combustible or explosive atmospheres.**

### 1.4 Inspection and Contents Checklist

Verify the contents and inspect the package immediately upon delivery. If the shipping container is damaged, check for internal damage and file a freight claim with the carrier if necessary. If the container is not damaged, remove the product from its protective package, noting how it was packed, and inspect each component for damage.

If shipping the product is required, it is best to use the original shipping container. The product must be packed correctly to ensure its safe transportation.

The product package should include the below items but may vary by region:

- IND500x terminal
- Quick Guide
- Bag of miscellaneous parts
- Safety Instructions

### 1.5 Physical Dimensions

The dimensions for the harsh enclosures of the IND500x terminal are shown below.



## 1.5.1 Harsh Enclosure

The physical dimensions for the harsh desk and wall-mount enclosures of the IND500x terminal are shown in the figures below, in mm and [inch].

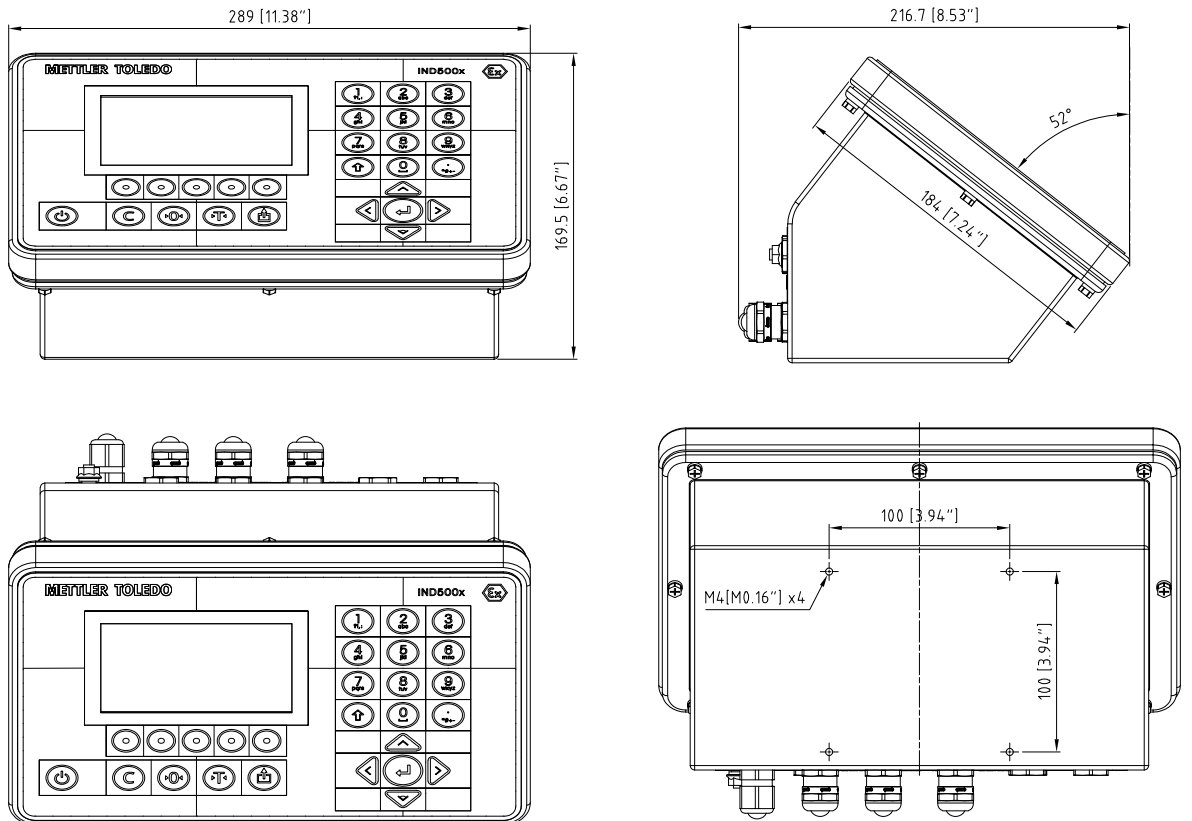

Figure 1: IND500x Harsh, Desk Mount Dimensions

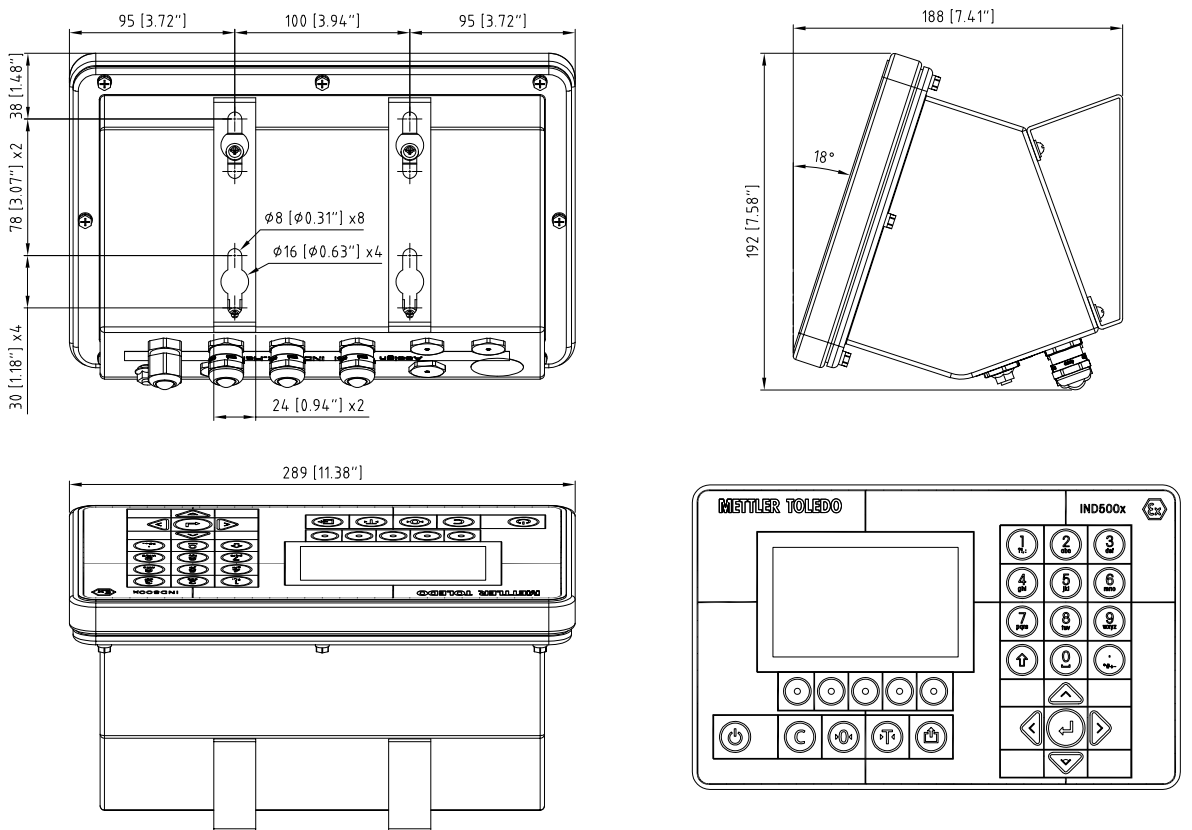

Figure 2: IND500x Harsh, Wall-Mount Dimensions

## 1.6 Specifications

<b>IND500x Specifications</b>	
Enclosure Type	Harsh environment desk/wall/column-mount: type 304 stainless steel enclosure
Dimensions	Harsh Environment: 289 mm x 184 mm x 162 mm (11.4 in. x 7.2 in. x 6.4 in.)
Shipping Weight	4.0 kg / 8.8 lb (net weight)
Package Size	388 mm x 255 mm x 290 mm (15.3 in. x 10.0 in. x 11.4 in.)
Environment Protection	Harsh Environment enclosure meets IP65 requirements.
Storage Environment	-20°C to 60° C (-4° to 140°F), 10% to 95% relative humidity, non-condensing.
Operating Environment	-10° to 40° C (14° to 104°F), 10% to 95% relative humidity, non-condensing.
Hazardous Areas	The IND500x is approved for use in Division 1 and Zone 1/21 hazardous areas. Before installation, check the data plate of the terminal to confirm it is marked with the approval for the environment in which it will be used.
Power	APS768x power supply with intrinsically safe outputs
Display	4.3" TFT color display (480 x 272), with 20 mm high weight display
Weight Display	Displayed resolution of 100,000 counts for analog load cell scales Display resolution for IDNet and SICSpro bases is determined by the specific base used.
Supported Scale Types	Analog load cells, High-Precision IDNet, High-Precision SICSpro
Analog Scale Interface	Load Cell Excitation Voltage: 4.8 VDC Minimum Sensitivity: 0.3µV/e approved Up to four 350 Ohms load cells, 1-3 mV/V
Number of Scales	Interface for one analog or one IDNet scale or one SICSpro scale
Analog/Digital Update Rates	Internal: Analog: >366 Hz; IDNet: determined by base; SICSpro: 50 Hz for bases that include Advanced Setup Mode Target Comparison: up to 50 Hz
Interface and Function Update Rates	Weight display: 25 Hz Internal discrete I/O: 50 Hz External discrete I/O (ARM100): 25 Hz PLC cyclic data: 25 Hz SICS continuous (SIR): up to 20 Hz MT Continuous Output: up to 20 Hz Continuous Template (serial): 18 Hz (115.2Kbaud), 14 Hz (38.4Kbaud) Continuous Template (Eprint): 20 Hz
Clock Accuracy	< 1 second / day (without time server access) at 25° C consistent room temperature.
VESA standard	100 x 100 mm
Keypad	27 keys, polyester overlay (PET) with hardcoating, Electro-static discharge protected, Polycarbonate (PC) display lens

<b>IND500x Specifications</b>	
Communications	<p><b>Standard Interfaces:</b></p> <ul style="list-style-type: none"> <li>• One intrinsically safe RS-232 serial port (COM1), 300 to 115,200 baud (maximum cable length: 10 m / 32.8 ft)</li> <li>• Discrete I/O with 3 active inputs and 3 passive outputs</li> </ul> <p><b>Optional Interfaces:</b></p> <ul style="list-style-type: none"> <li>• Discrete I/O interface with 5 inputs and 8 outputs</li> <li>• Intrinsically safe RS-232 serial port (COM6), 300 to 115,200 baud (maximum cable length: 10 m / 32.8 ft)</li> <li>• Intrinsically safe analog 4-20mA output interface (maximum cable length: 300 m / 984.3 ft)</li> <li>• Dual-channel intrinsically safe active current loop interface to communicate with ACM200 or ACM500 (maximum cable length: 300 m / 984.3 ft)</li> <li>• Fiber optic interface (to communicate with ACM500) (maximum cable length: 300 m / 984.3 ft)</li> </ul> <p><b>Protocols</b></p> <ul style="list-style-type: none"> <li>• Serial Inputs: ASCII commands for CTPZ (Clear, Tare, Print, Zero), SICS (most level 0 and level 1 commands), and Shared Data Server Access</li> <li>• Serial Outputs: Continuous or Demand with up to ten configurable print templates or SICS host protocol, report printing</li> <li>• Profinet: Standard Automation Interface (SAI) 1, 2 and 4 block format</li> </ul>
PLC Interfaces	<p>Interfaces with external ACM200 in safe area for RS232, RS422/RS485</p> <p>Interfaces with external ACM500 in safe area for Ethernet, RS232, RS422/RS485 and Profinet, PROFIBUS DP, EtherNet/IP, Modbus TCP</p>
Approvals	<p><b>Weights &amp; Measures</b></p> <ul style="list-style-type: none"> <li>• USA: NTEP Class II 100,000d; Class III/IIIL 10,000d</li> <li>• Canada: Class II 100,000d; Class III 10,000d; Class IIIHD 10,000d</li> <li>• Europe: OIML R76 Class II approved divisions determined by platform; Class III 10,000e and Class IIII 1,000e; MID R61 (Automatic Gravimetric Filling Instrument); MID R51 (Automatic Catchweigher)</li> </ul> <p><b>Hazardous Locations</b></p> <ul style="list-style-type: none"> <li>• <b>ATEX</b> for Zone 1 and Zone 21 FM21ATEX0033X</li> <li>• <b>IECEx</b> , Equipment Protection Level Gb and Db IECEx FMG 21.0022X</li> <li>• <b>FMus</b> for US, DIV 1 and Zone 1 and Zone 21 FM21US0064X</li> <li>• <b>cFM</b> for Canada, DIV 1 and Zone 1 and Zone 21 FM21CA0040X</li> </ul>

## 1.7 Main PCB

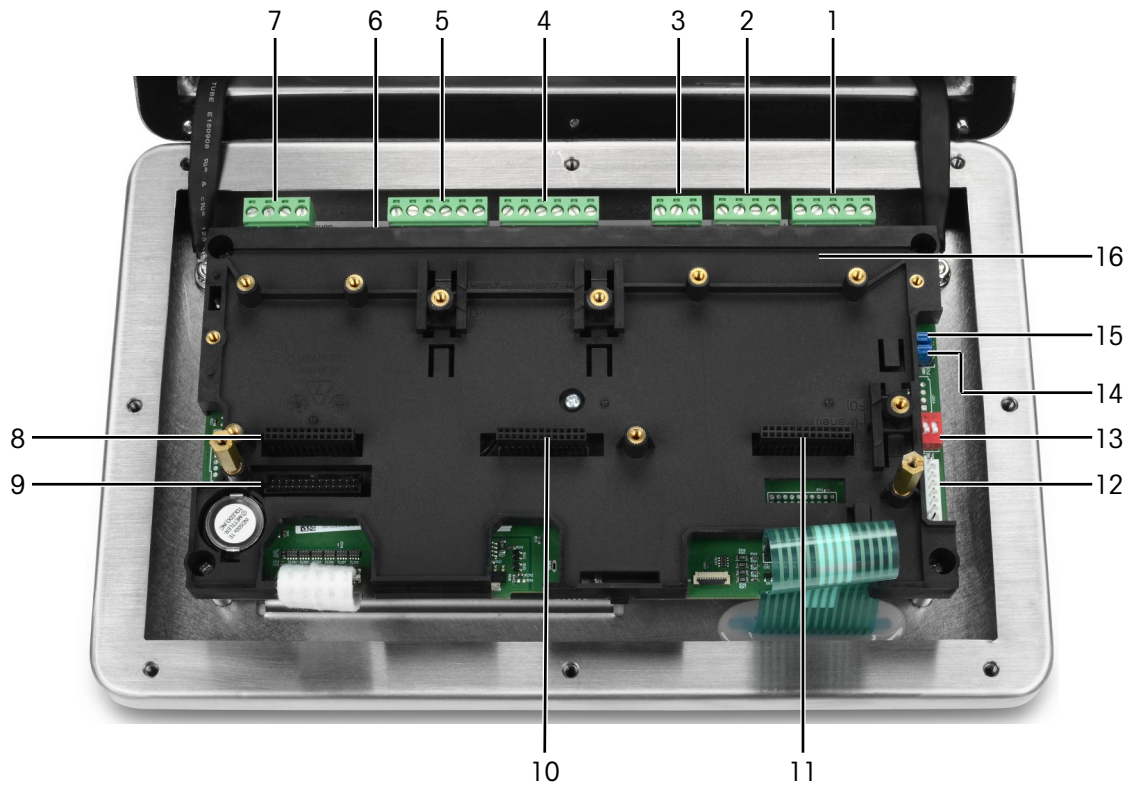

Figure 3: Main Board of IND500x installed with installation bracket

1, 2	Power Input	For connection with APS768x power supply
3	Reserved power input	
4	Active input (3I)	
5	Passive output (3O)	
6	SW2	
7	COM 1 (RS232)	
8	Slot 1	For connection of <ul style="list-style-type: none"> <li>• Analog scale interface</li> <li>• Digital scale interface</li> </ul>
9	Slot 2	For connection of <ul style="list-style-type: none"> <li>• RS232 interface</li> </ul>
10	Slot 3	For connection of <ul style="list-style-type: none"> <li>• 4-20mA interface*</li> <li>• Discrete I/O interface</li> </ul>
11	Slot 4 (J701)	For connection of <ul style="list-style-type: none"> <li>• 4-20mA interface*</li> </ul>
12	Slot 4 (J702)	For connection of <ul style="list-style-type: none"> <li>• Current loop interface</li> <li>• Fiber optical interface</li> </ul>
13	SW1	
14	W2 Jumper	Reserved for future use
15	W1 Jumper	<ul style="list-style-type: none"> <li>• To enable or disable On/Off key, or</li> <li>• Reserved for future use</li> </ul>
16	Main Board Installation Bracket	

\* IND500x supports only one 4-20mA analog output, which can be installed in either Slot 3 or Slot 4.

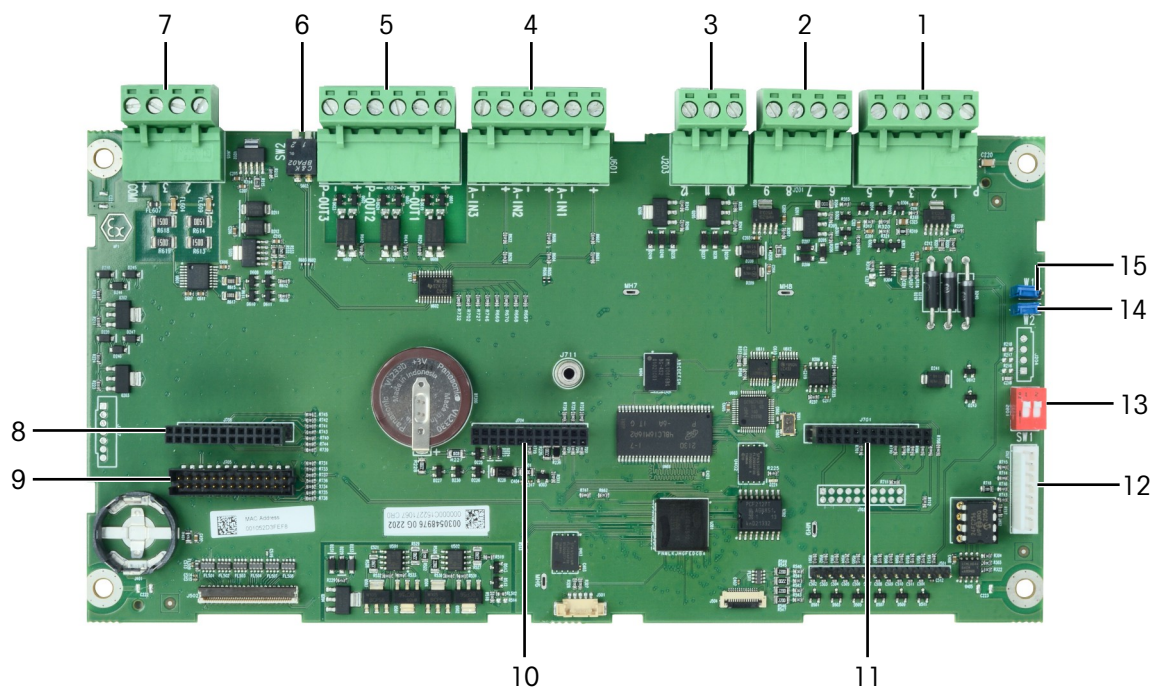

Figure 4: Main Board of IND500x

## 1.8 Communication Board Options

- 4-20mA interface
- RS232 interface (COM6)
- Analog scale interface
- Digital scale interface (for IDNet or SICSpro scale base connection)
- Discrete 5I/8O interface
- Current loop / fiber optic interface (for connection with ACM500)

Refer to [Main PCB ▶ Page 16] for connection possibilities of these interfaces with the main board.

# 1.9 Configuration

## 1.9.1 System Configuration

The following figure shows the configuration options for the terminal.

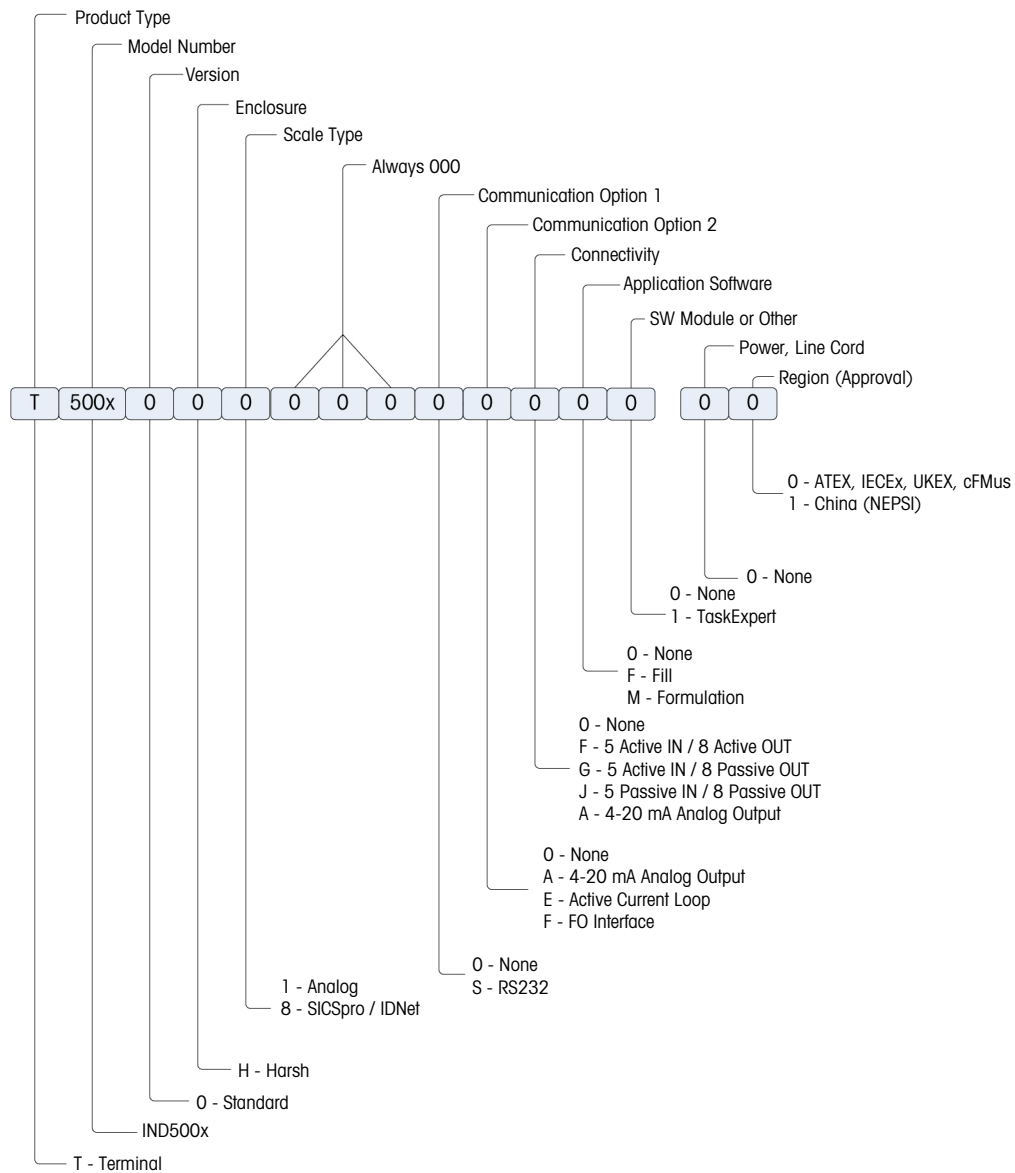

Figure 5: IND500x Configuration Chart

## 1.9.2 Connections

The enclosure entries are blank holes of 16 (+0.15/-0) mm in diameter. See more information in Harsh Enclosure Cable Glands.

The following figure shows the connection locations on the back of the harsh enclosure.

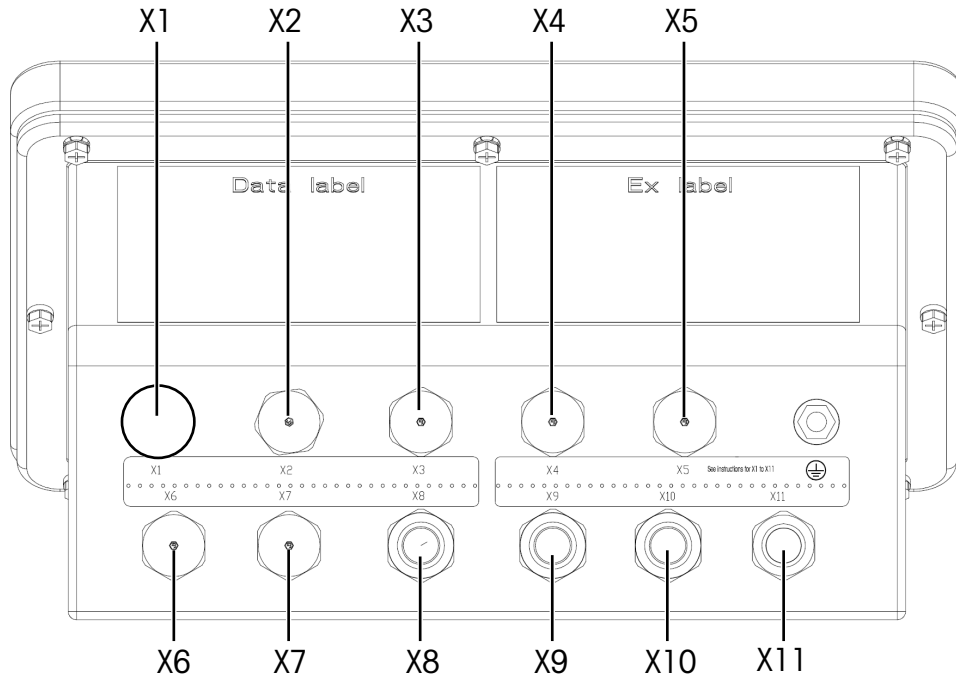

Figure 6: IND500x Connectors

### Cable Gland Usage and Corresponding Cable Diameter

Connection Location NO.	Primary Use		Alternative Use	
	Used Connector for	Cable Diameter	Used Connector for	Cable Diameter
X1 <sup>(1)</sup>	Power supply	6 - 10mm (0.24-0.39in.)	Scale interface	4 - 8mm (0.16-0.31in.)
X2	Discrete 5I/80	6 - 10mm (0.24-0.39in.)	COM1	6 - 10mm (0.24-0.39in.)
X3	Discrete 5I/80 or analog 4-20mA output	6 - 10mm (0.24-0.39in.)	Discrete 3I/30	6 - 10mm (0.24-0.39in.)
X4	Discrete 5I/80 or analog 4-20mA output	6 - 10mm (0.24-0.39in.)	Discrete 3I/30	6 - 10mm (0.24-0.39in.)
X5	COM6	6 - 10mm (0.24-0.39in.)	Power supply	6 - 10mm (0.24-0.39in.)
X6	Current loop or analog 4-20mA output or Fiber optic*	6 - 10mm (0.24-0.39in.) * 2 drill-hole HSK-M-Multi-Ex	COM6	6 - 10mm (0.24-0.39in.)
X7	Current loop or analog 4-20mA output or Fiber optic*	6 - 10mm (0.24-0.39in.) * 2 drill-hole HSK-M-Multi-Ex	Discrete 5I/80	6 - 10mm (0.24-0.39in.)
X8	Discrete 3I/30	6 - 10mm (0.24-0.39in.)	Discrete 5I/80 or analog 4-20mA output	6 - 10mm (0.24-0.39in.)
X9	Discrete 3I/30	6 - 10mm (0.24-0.39in.)	Discrete 5I/80 or analog 4-20mA output	6 - 10mm (0.24-0.39in.)
X10	COM1	6 - 10mm (0.24-0.39in.)	Current loop or analog 4-20mA output or Fiber optic*	6 - 10mm (0.24-0.39in.) * 2 drill-hole HSK-M-Multi-Ex
X11	Scale interface	4 - 8mm (0.16-0.31in.)	Current loop or analog 4-20mA output or Fiber optic*	6 - 10mm (0.24-0.39in.) * 2 drill-hole HSK-M-Multi-Ex



### **⚠ WARNING**

<sup>(1)</sup> X1 is covered with a protective tape before shipping. If X1 is used for power supply or scale interface, remove the protective tape and use the ATEX/IECEx cable gland. If X1 is left not used, remove the protective tape and block it with an ATEX/IECEx Dummy Stopper. Refer to Harsh Enclosure Cable Glands and Power Connection for more information.



### **Important Safety Message**

The cable diameters do not correspond to the enclosure openings, but to the cables used. The cable diameter and the cable gland used must fit.



### **⚠ WARNING**

The IP65 protection must always be maintained. Both the Installation Personnel and customers should not do anything that could damage the terminal.

## **1.10 Manufacturing Date**

The manufacturing date or the date code for the terminal can be found on the serial data plate (on top of the enclosure). See also Chapter 7.1.10 [Marking Plate Example ▶ Page 178].

## **1.11 Compliance Information**

National approval documents, e.g. the FCC Supplier Declaration of Conformity, are available online and/or included in the packaging.

▶ [www.mt.com/ComplianceSearch](http://www.mt.com/ComplianceSearch)





## 2 Operation

This chapter provides information about navigation, basic features and functions, user notifications, easy file transfer and report generation using the terminal. Specific operation of each terminal depends on enabled functions and parameters that are configured in Setup. Individual setup parameters are described in [Setup and Configuration ▶ Page 60]. Configuration and operation of some of the more complex terminal applications are further detailed in [Application ▶ Page 99].

### 2.1 User Security

It is often required that equipment access or use be limited according to the security clearance of the user. These limitations may be due to legal regulations or to customer preference. Some installations operate in a "trusted" environment, where security is managed within the scope of the operation perimeter and no additional security is required from the weighing terminal. The opposite extreme may be found in highly regulated industries where every operation must be recorded and authorized by signature or login.

This terminal supports 3 levels of user security that rely on appropriate username/password entry for access to Setup and terminal functions accessible from the Home screen. Refer to [Default Settings ▶ Page 194], to determine security levels assigned to specific setup parameters and Home screen functions.

- |                      |  |  |
|----------------------|--|--|
| <b>Administrator</b> |   | An Administrator has unlimited access to all areas of the operating and setup system. At the factory, the terminal is configured with a default account <b>Admin</b> and default password is <b>null</b> (no password). The Admin can't be deleted or renamed.   |
| <b>Supervisor</b>    |   | A Supervisor has full access to all features on operating level and limited access to the weight and measurement-related setup.  |
| <b>Operator</b>      |  | The operator has read access only (e.g. call targets, use tables, etc.) to standard operation and setup. At the factory, the terminal is configured with a default operator account with a username of <b>Operator</b> . The factory default password is <b>null</b> (no password). This default account has limited access to Setup. The Operator can be deleted or renamed on the setup. |

User settings can be modified. See Chapter 4.1 [Entering Setup Mode ▶ Page 60], or Chapter 4.8.6 [Users ▶ Page 114].

Auto Logout can be modified. See Chapter 4.8.6 [Auto Logout ▶ Page 115].



#### Important Safety Message

**When setting a password for a user, be sure to remember it and protect it from access by unauthorized personnel. If the password is changed or forgotten, access to the Setup menu and some terminal functions will be lost. To regain access and functionality, a master reset of the terminal must be performed. This will reset all usernames and passwords, but also remove any custom configuration.**

#### 2.1.1 Accessing Setup and Terminal Functions

To save time, the first thing a user should do when entering Setup to view or make modifications to configuration is to Log in with the correct access level by the LOGIN softkey .

If a user doesn't have the security level to access the setting in setup, an Error Message "Invalid - No Access Level" pops up. In such case, user needs to Press the Enter Key to confirm this Error Message Box, and then returns back to the Home Screen and Logs in with the correct access level by the LOGIN softkey .

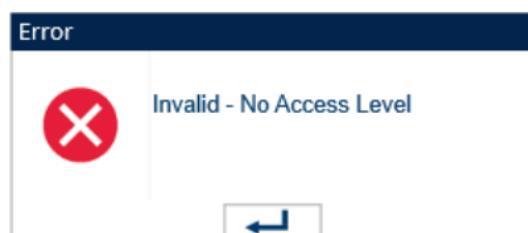

Figure 7: Error Message - No Access Level

The user can enter any username/password stored in the User table. Successful entry will grant security access at the level associated with the entered account.

### See also

[Users](#) ▶ Page 114

## 2.1.2 Metrology Switch

If the Metrology switch (SW1-1) is placed in the approved (ON) position, access to the Scale branch of setup and to other metrologically significant areas is not permitted. The metrology switch can be used to prevent Administrator level users from accessing metrology features even if the region approval is "None".

Selecting a specific region approval and setting the Metrology switch to ON alters some scale functions:

If the approval is **Canada** The terminal's functions are changed as follows:

- The keyboard tare command carries out a rounded tare.
- The center of zero division is 0.2d. The default value for non-approved mode is 0.25d.

If the approval is **OIML**

- The power up zero range should not exceed a total of 20%, and the pushbutton zero range should not exceed a total of 4%. For instance, the power up zero range can be set to 18% to -2%, and the pushbutton zero range can be set to +/- 2%. These parameter should be entered by users.
- The selection of non-SI units is not permitted. The only units available for selection are kg, t, and g.
- The Power Up Delay setting (at [Scale Type ▶ Page 64]) for analog scale types is only shown when approval is OIML.

If the approval is **Argentina**

The terminal's functions are changed as follows:

- When Metrology Switch SW1-1 is ON, changes to metrologically significant areas in the menu tree is prohibited. If an attempt is made to change any metrologically significant parameter, the onscreen message "Access defined. Scale is Approved." appears.
- All shared data server write ability via COM1 (serial) and Ethernet is disabled. Information can still be read from shared data, but writing to shared data is not possible.
- The FTP server (both serial and Ethernet) can only read files from the terminal. It cannot write anything to the terminal. Shared data field nf0101 will automatically be set to 2 (read only).
- If SICS is selected as an assignment for a port, all SICS commands must be disabled. When a SICS command is received, an "EL" response is returned.
- A preset tare from the front panel, from the tare table, received serially (for example 1.00T via the CTPZ input assignment) or received from a PLC, can only be accepted if there is no motion on the scale. If motion is detected, the terminal should wait for the programmed stability timeout period and, if the motion continues, discard the request. The preset tare feature will therefore operate just like the semi-automatic tare feature.

If the approval is **Korea**

The terminal's functions are changed as follows:

- The selection of non-SI units is not permitted. The only units available for selection are kg, t, and g..

Access to the Metrology Switch may be sealed in conformity with local regulations in "legal-for-trade" applications. Refer to [Main PCB ▶ Page 16] for location of the Metrology switch. Refer to PCB Switch Settings for further information about SW1-1 and SW1-2 switch settings.

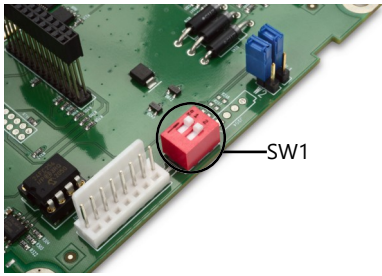

Figure 8: Metrology Switch







## NOTICE

**After setting the terminal to approved, and before exiting Setup, SW1-1 should be switched to ON. Take care when setting the switch in the powered terminal.**

## 2.2 Terminal Operation

Key names and commands are identified in this manual by upper- and lower-case letters. Key names, such as ENTER, are in all upper-case letters, and commands, such as “select,” are in lowercase (unless they begin a sentence, in which case the first initial is upper-case). For example:

“Press START...” means to press the START softkey .

“Select an option...” means to use the UP or DOWN navigation keys ( ) to highlight a setting, then press the ENTER key (.

## 2.3 Understanding the HMI (Human Machine Interface)

Navigation within applications and configure the terminal using:

- Navigation keys
- Scale function keys
- Softkeys
- Shared numeric and alpha keys

The locations of these keys and the display screen area are shown in the following figure.



Figure 9: Key Locations and Display Screen

- 1 Weight and application area

- 2 Softkey labels
- 3 Softkey buttons
- 4 Power On/Off key
- 5 CLEAR key
- 6 ZERO key
- 7 TARE key
- 8 PRINT key
- 9 Navigation keys
  - UP navigation key
  - DOWN navigation key
  - LEFT navigation key
  - RIGHT navigation key
  - ENTER key
- 10 Legend area
- 11 Alphanumeric keypad

### 2.3.1 Navigation Keys

The navigation keys (see [Understanding the HMI (Human Machine Interface) ▶ Page 23]) enable navigation within the Setup menu tree, setup screens, and application screens.

#### 2.3.1.1 UP and DOWN Navigation Keys

The UP and DOWN navigation keys (⬆️⬇️) move the focus up or down to different setup options within the menu tree (focus is indicated by highlighted text), to different fields within a setup page, and to switch to another page of available softkeys. The UP and DOWN navigation keys are also used to move to a next or previous page when a scroll bar indicates that two or three pages are used for configuration fields associated with a specific parameter.

The example in the following figure shows a configuration parameter that requires three pages to display all of the associated configuration fields. The scroll bars indicate which page of the three is displayed.

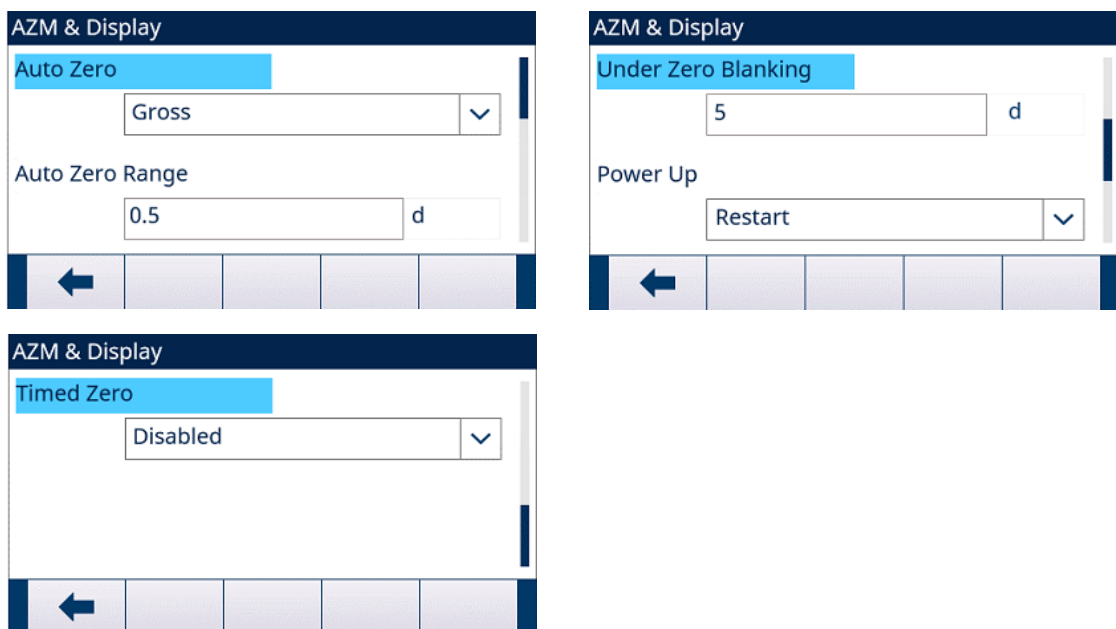

Figure 10: Example of Scroll Bars, Indicating Three Pages of Configuration Fields

Press the DOWN navigation key (⬇️) to move from page 1 to 2 or from page 2 to 3. Press the UP navigation key (⬆️) to move from page 3 to 2 or from page 2 to 1.

### 2.3.1.2 LEFT and RIGHT Navigation Keys

The LEFT and RIGHT navigation keys (◀▶) are used to:

- Expand (RIGHT navigation key ▶) the setup options in the menu tree
- Collapse (LEFT navigation key ◀) the setup options in the menu tree
- Move the cursor position to a specific character in text areas
- Enable left and right scrolling to view all information available on a screen

### 2.3.1.3 ENTER Key

The ENTER key (↵) is used to:

- Open the setup page for viewing and editing setup parameters
- Move the focus from a field label to a setup value for that field
- Accept new values entered in a field and move the focus to the next field label













### 2.3.2 Softkeys and Icons

Five softkey buttons (⊙) (see [Understanding the HMI (Human Machine Interface) ▶ Page 23]) are located along the bottom of the display screen. A graphic icon that identifies a softkey's function is displayed directly above each softkey. Five softkey identifiers or labels can be displayed at one time. The terminal supports up to a total of 15 possible softkey functions, displayed on three separate pages. A MORE LEFT symbol (◀) or a MORE RIGHT symbol (▶) displayed on left or right corner of the screen indicates that more softkey selections are available. Press the LEFT or RIGHT navigation keys (◀▶) to display additional softkey screens.







Configuration | Terminal | Softkeys provides further detail on the configuration and customization of softkeys.

Softkeys and application displays use graphic icons for identification. The following tables list these icons and their functions, categorized according to their use/s within the HMI. Refer to [Default Settings ▶ Page 194], for additional details on the security levels for these softkey associated functions.

#### Icons

Icon	Function	Icon	Function
	Motion		Numeric Data Entry
	Center of Zero		Upper Case Alpha Entry
	x10 Display		Lower Case Alpha Entry
	MinWeigh		Event Alert
	Customized Unit		Range 1
	Range 2		Range 3

#### Softkeys on Home Screen

Icon	Function	Icon	Function
	Alibi Memory (Alibi Table)		Tare Memory (Tare Table)
	Comparators		Time & Date
	Custom Print Trigger 1		Transaction Counter

Icon	Function	Icon	Function
	Custom Print Trigger 2		Unit Switching
	Custom Print Trigger 3		Brightness Adjust
	Expand x10		Totals Recall
<b>ID1</b>	ID 1		Login
<b>ID2</b>	ID 2		Event Alert Recall
<b>ID3</b>	ID 3		Setup
<b>ID4</b>	ID 4		Repeat Print
	Information Recall		MinWeigh











\* Note that for IDNet platforms in the approved mode, in order for the x10 function to operate properly, the Update Rate must be set at 20. Values of 5 or 10 for the update rate will result in longer display of the expanded weight value, which is not permitted.

#### Softkeys on Setup Screens







Icon	Function	Icon	Function
	Clear		Exit
	Copy		Edit
	Delete		OK
	Add	-	-

#### Softkeys of Memory and Table Functions









Icon	Function	Icon	Function
	Clear		Tare

Icon	Function	Icon	Function
	Transfer		View Table
	Edit		Clear Table Total
	Reset		Update
	Clear Subtotal		Delete
	Filter Off		Filter On
	Filter Clear	-	-

#### Softkeys of Calibration Function

Icon	Function	Icon	Function
	CalFree Calibration		Step Calibration
	Start		Zero Calibration
	IDNet Service Mode		Span Calibration
	Skip	-	-

#### Softkeys of Information Recall

Icon	Function	Icon	Function
	Totals Recall		Weight Recall
	System Information Recall		TaskExpert
	Metrology Recall		Terminal Status
	Transfer		Connected Devices
	Service Information Recall	-	-

### Softkeys of Special Control

Icon	Function	Icon	Function
	Clear Total		Bump Up
	Bump Down		Nudge Down
	Next		Nudge Up
	Reset		Output Off (discrete I/O)
	Reset Transaction Counter		Output On (discrete I/O)
	Start		No / Cancel
	Stop		Brightness Bright
	Brightness Dark		Logout
	Pause	-	-

### 2.3.3 Scale Function Keys

The scale function keys, indicated in [Understanding the HMI (Human Machine Interface) ▶ Page 23], are:

- 
**ZERO**

When the scale platform or weighbridge is empty, the terminal should indicate zero. The gross zero reference is recorded during calibration. Press the ZERO scale function key to capture a new gross zero reference point if pushbutton zero is enabled in configuration and the weight is within the zero range.
- 
**TARE**

Tare is the weight of an empty container. Tare is normally used to determine the net weight of the contents of a container. Press the TARE scale function key when an empty container is on the scale. The terminal then displays a zero net weight. As the container is loaded, the terminal then displays the net weight of the contents. Pushbutton tare must be enabled to use this key in this manner.

When an empty weight of the container is a known value, enter the tare weight using the numeric keys and then press the TARE scale function key. Then terminal will display the net weight of the contents of the container. Keyboard tare must be enabled in order to use this key in this manner. If the secondary Tare display is enabled (i.e. Tare Display (under Setup | Terminal | Display | Tare Display) selects Active or Always) , the tare value and type of tare will show in the lower left of the display (see [Home Screen ▶ Page 32]).





### CLEAR

When in the net weight mode, press the CLEAR scale function key to clear the current tare value; the display will revert to the gross weight value. The CLEAR scale function key operates regardless of motion on the scale. Note that once the tare value has been cleared, it cannot be recalled. The complete tare process as described above must be performed.

When in alphanumeric entry mode, the CLEAR key functions like a backspace key. Position the cursor at the end of data to be deleted and press the CLEAR key. Press the CLEAR key once for each character to be deleted. When first entering a data entry box, the previous entry will be in focus. Pressing the CLEAR key at this point will clear the entire previous entry.



### PRINT

Press the PRINT scale function key to initiate a demand output of an assigned print template. A serial or Ethernet print connection must be configured to link a template to the selected serial or Ethernet port. When a print command is issued, "Printing" appears in the system line for 3 seconds (see [Understanding the HMI (Human Machine Interface) ▶ Page 23]).

## 2.3.4 Alphanumeric Keys

When data entry is required, use the terminal's 12-key alphanumeric keypad to enter letters, numbers and special characters.

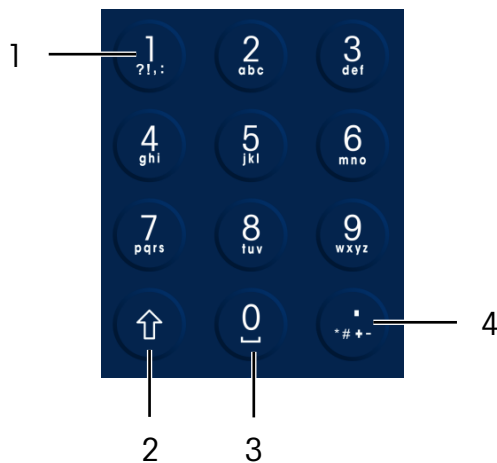

Figure 11: Alphanumeric Keypad

- |   |                              |   |   |
|---|------------------------------|---|---|
| 1 | 1 and punctuation characters | 3 | 0 and space                                   |
| 2 | Shift key                    | 4 | Decimal and additional punctuation characters |

Position the cursor in the field (see [Navigation Keys ▶ Page 24]) and press the alphanumeric keys to enter the appropriate data. Press the DECIMAL key (.) to enter decimal points where necessary. A setup parameter, at [Print Comma/Decimal ▶ Page 114], changes this decimal input to a comma.

During data entry, the CLEAR key (C) functions like a backspace key (see [Understanding the HMI (Human Machine Interface) ▶ Page 23]). Position the cursor at the end of data to be deleted and press the CLEAR key (C) once for each character to be deleted. When a data entry box is first selected, the entire data string will be in focus. Pressing CLEAR (C) at this point will clear the entire previous entry.

The EXIT (←) softkey exits the data entry process without accepting any of the new data typed. Any data that was in the entry field before the new entry was initiated will remain there. Once desired alphanumeric characters have been entered in appropriate fields on the screen, press the ENTER key (↵) to accept the entries.

## 2.4 Data Entry

When data entry is possible, an entry mode graphic will appear at the top right of the terminal display, as shown in the following figure. The entry mode graphic represents one of several possible entry modes as listed in the following table.

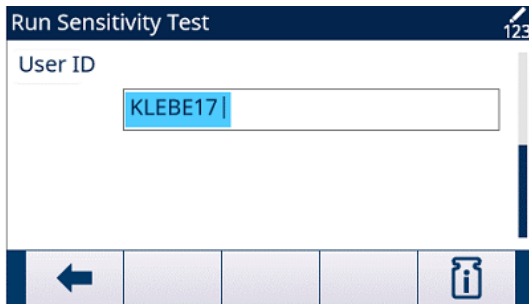





Figure 12: Data Entry Mode Type

### Data Entry Modes

Graphic	Entry Mode
	Numeric Entry
	Upper Case Alpha Entry
	Lower Case Alpha Entry



The SHIFT key (⇧) on the keypad (refer to [Alphanumeric Keys ▶ Page 29]) is used to change between the available entry modes. The modes available depend on the type of entry field selected.

### 2.4.1 Data Entry Modes

#### 2.4.1.1 Numeric Entry

In numeric entry  mode, only the numeric value shown on the key pressed is entered. Multiple presses of the numeric key will result in multiple entries of the same number. The decimal point is also available.

#### 2.4.1.2 Upper- and Lower-Case Alpha Entry

In upper-case alpha entry  or lower-case alpha entry  mode, the first character shown under the large number on the key pressed is entered (either a capital or lower case letter, except for the "1" key (1) and the "." key (.)). Each key supports multiple characters. To enter the second character shown on the key, press the key a second time before the timeout period. To enter the third character shown on the key, press the key one more time before the timeout period. If the key is pressed again before the timeout, it will show the next character (for the "1" (1) and "." (.) keys) or wrap back around to the first character. The space key (space) is also accessed in these modes.

When a language other than English is selected in terminal setup, various unique characters for the selected language will become available when their respective key is pressed.

### 2.4.2 Special Symbols and Punctuation Entry

Two of the keys provide access to punctuation and other special characters and symbols. Due to the number of characters associated with "1" key (1) and "." key (.), these keys function differently than the other alphanumeric keys. When in the upper-case or lower-case letter entry mode, pressing the "1" key (1) or the "." key (.) will generate a pop-up screen with the first character in focus.

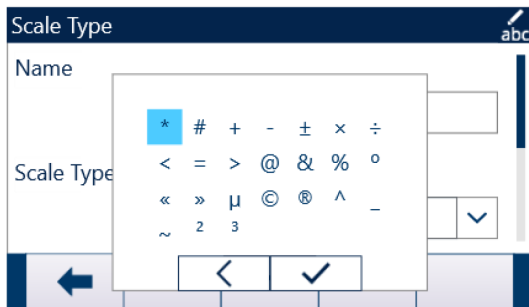

Figure 13: "." Key Characters

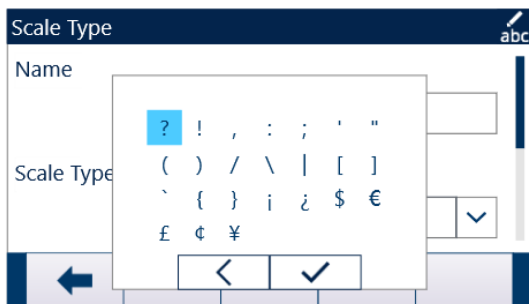

Figure 14: "1" Key Characters

Press the navigation keys (⬆️⬇️⬅️⬇️) until the desired character is in focus, and press the ENTER key (⏎).

The table **Special Symbols and Characters** shows available symbols and special characters and their access key when the Keypad is selected as English, Global, or Russian. If an incorrect character is entered, the CLEAR key (Ⓞ) will delete the character from the data entry box.

To exit without selecting a character, press the far left softkey (⬅️). The far left softkey functions as an ESCAPE or EXIT softkey key when no softkey is actually displayed.

### Special Symbols and Characters

Key	Keyboard Settings
1	? ! , ; ' " ( ) / \   [ ] ` { } i z \$ € £ ¢ ¥
Decimal (.)	* # + - ± × ÷ < = > @ & % ° « » μ © ® ^ _ ~ ² ³

## 2.4.3 Global Character Entry

If **Keypad Selection** (in Setup at **Terminal | Region | Language**) is set to **Global**, all the international characters will be added to the end of the standard alpha character rotation for the associated key. For example, when **Global** is selected, all the international versions of the letter "e" that are supported in the ISO8859-15 character set are added to the end of the character selections on the "d e f" key (Ⓝ) after the letter "f". [Global Character Entry ▶ Page 31] shows which keys support which characters, and the sequence in which they appear.

**Note that no additional characters are associated with the "5" key (Ⓟ).**

**Russian Cyrillic characters are not supported through the shared alphanumeric keypad.**

### Global Characters

Mode	Key	English	Global
	2	A B C	A B C À Á Â Ã Ä Å Æ Ç
	3	D E F	D E F È É Ê Ë
	4	G H I	G H I Ì Í Î
	5	J K L	J K L
	6	M N O	M N O Ñ Ò Ó Ô Õ Ö Ø
	7	P Q R S	P Q R S Š
	8	T U V	T U V Ø Ù Ú Û Ü
	9	W X Y Z	W X Y Z Ý Ž Ž

Mode	Key	English	Global
	2	a b c	a b c à á â ã ä å æ ç
	3	d e f	d e f ð è é ê ë
	4	g h i	g h i ï í î ï
	5	j k l	j k l
	6	m n o	m n o ñ ò ó ô õ ö oe
	7	p q r s	p q r s ß š
	8	t u v	t u v ø ù ú û ü
	9	w x y z	w x y z ý ÿ ž

## 2.5 Home Screen

The Home screen is the only screen that provides operator access to the programmable softkeys.

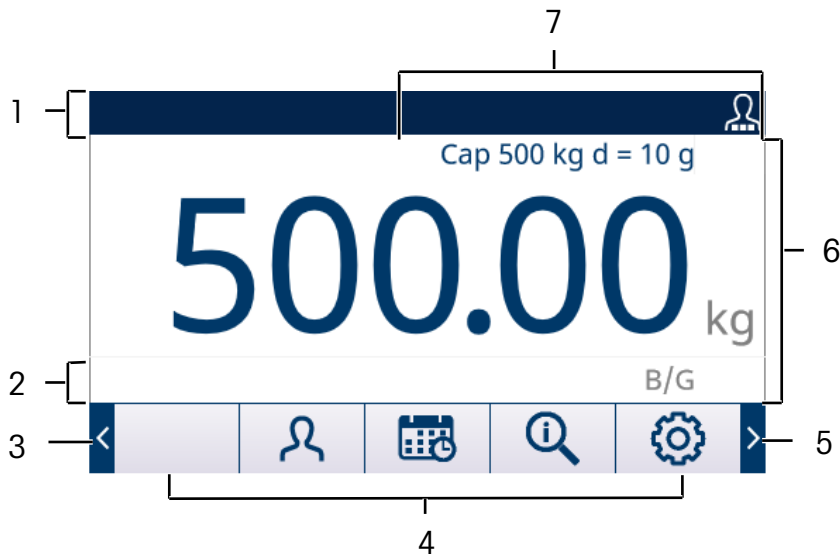





Figure 15: Default Home Screen

The appearance of the Home Screen will vary depending on the terminals' configuration, but it can include\*:

- |   |                             |  |
|---|-----------------------------|--|
| 1 | System Line                 | Displays system messages, application data and the service icon.   |
| 2 | Legend Area                 | Displays Tare value, MinWeigh, Motion, Center of Zero, Range/Interval and weighing mode.   |
| 3 | More Left Symbol            | Press the LEFT navigation key  to display more softkeys.  |
| 4 | Softkey Labels              | Displays the icons for the active softkey functions. The appearance of MORE LEFT or MORE RIGH symbol   indicates that more softkey selections are available. |
| 5 | More Right Symbol           | Press the RIGHT navigation key  to display more softkeys.   |
| 6 | Weight and Application Area | Displays weight, units, tare and other application-specific weighing data.   |
| 7 | Metrology Line              | Displays capacity, increment settings and approval class symbol.   |

\* Not all possible Home screen functions and display items are listed.

## 2.6 Basic Functionality

This section provides information about the terminal basic functionality. Additional areas of functionality specific to application software available for the terminal are addressed in the specific application manuals. Basic functions addressed in this section include:

- Zero
- Expand by 10
- CalFree™
- Calibration Management
- Tare
- Print
- MinWeigh
- Information Recall
- Unit Switching
- Totalization
- Time and Date
- Table Searches

- ID
- Comparators
- Target Comparison
- Alibi Memory
- Reports
- Email

For details on activating some of the more complex functions of the terminal, please refer to [Setup and Configuration ▶ Page 60] and [Application ▶ Page 99].

## 2.6.1 Zero

The Zero function is used to set or reset the initial zero reference point of the terminal.

There are three types of zero setting modes:

- Automatic Zero Maintenance
- Power-Up Zero
- Pushbutton Zero

### 2.6.1.1 Automatic Zero Maintenance

Automatic Zero Maintenance (AZM) enables the terminal to compensate for the buildup of small amounts of weight and track itself back to the center of zero. Within the AZM operating range (programmable from 0.00 to 10.00 divisions), when the terminal is in a no motion condition, it makes small adjustments to the current zero reading to drive the weight reading toward the true center-of-zero. When the weight is outside of the programmed AZM range, this feature is not functional.

### 2.6.1.2 Power-Up Zero

Power-Up Zero enables the terminal to capture a new zero reference point after power is applied. If the terminal detects motion during a power-up zero capture function, it will continue to check for a no-motion condition until zero is captured. Power-up zero can be disabled or enabled, and the acceptable range above and below calibrated zero configured. The range is programmable from 0% to 100% of capacity and can include a positive range and also a range below calibrated zero.

### 2.6.1.3 Pushbutton Zero

The pushbutton (semi-automatic) zero function can be accomplished by:

- Pressing the ZERO scale function key 
- Programming a discrete input for zero and then activating this discrete input
- PLC command to the terminal
- Serial command (SICS or CTPZ protocols)
- A custom application

The range for all types of pushbutton zero is selectable (0% to 100%) plus or minus from either the calibrated zero point (if power-up zero is disabled) or from the initial zero setting point (if power-up zero is enabled).

Remote initiation of the pushbutton zero command is possible via a discrete input, an ASCII 'Z' command sent serially (CPTZ and SICS), a command initiated by the PLC interface, or from an application.

### 2.6.1.4 Timed Zero

The Timed Zero function works to monitor the weighing system to ensure that the scale sees the center of zero at stability within a certain time. This function has been implemented to satisfy requirements of the MID R51 approval for automatic catch weighing equipment.

The Timed Zero function is a combination of internal timer, display messages and a discrete output alarm. Once Timed Zero is enabled, an internal timer is initialized. If the scale sees the center of zero with no motion, the timer resets and the sequence begins again. If the scale does not see zero before the timer expires, the terminal will turn on the Zero Requested discrete output and displays a "Zero Required" message in the system line.

After this, the timing sequence begins again. If the scale sees the center of zero with no motion, the discrete output is turned off, the timer resets and the sequence starts over again. If the timeout expires first, the terminal will turn off the Zero Requested discrete output for 200ms then turn it back ON and display the "Zero Required" message again in the system line.

After this, the timing sequence begins again. If the timer expires a third time without resetting, the terminal will:

- Turn off the Zero Requested discrete output for 200ms then turn it back on
- Display the "Zero Required" message again in the system line

- Shows dashes in the weight display to indicate invalid data
- Activate the System Error Alarm discrete output
- Set the Data Valid bit within the PLC cyclic data as invalid
- Change Status Word B of the Continuous Output data stream to indicate zero not captured

At this point, the scale must see the center of zero at stability or it will remain disabled. After seeing center of zero at stability (a Zero command may be required), all data outputs will return to valid status, the weight display will reappear, the Zero Requested discrete output will turn off and the System Error Alarm output will return to off status.



## NOTICE

**It is recommended to leave Timed Zero disabled (its default setting) unless the application/installation requires MID R51 approval.**

### 2.6.2 Tare

Tare is the weight of an empty container. A tare value is subtracted from the gross weight measurement, providing a net weight (material without the container). The tare function can also be used to track the net amount of material being added to or removed from a vessel or container. In this second case, the weight of the material in the container is included with the tare weight of the container as tare. The display then reflects the net amount being added to or removed from the vessel.

The terminal display area can be configured in Setup to display the active Tare value in the auxiliary display area (see [Home Screen ▶ Page 32] ). Depending on the tare type, the numeric tare value may display with a "T" label or a "PT" label. Tare types and associated operations available on the terminal include Pushbutton Tare, Keyboard Tare (Preset Tare), Net Sign Correction, Auto Tare and Clear Tare.

#### See also

[Home Screen ▶ Page 32](#)

#### 2.6.2.1 Pushbutton Tare

Pushbutton tare can be configured in Setup as enabled or disabled. When disabled, the TARE scale function key  cannot be used to obtain a tare.

If enabled, pressing the pushbutton TARE scale function key  initiates a semi-automatic tare. The terminal will attempt to perform a tare process. If successful, the display changes to a zero net weight indication and the previous weight on the scale is stored as the tare value. The net mode will be indicated on the display. If the Tare display is enabled, the pushbutton tare value will be shown with a T label.

Several conditions could prevent the pushbutton tare function from working:

#### Motion

Pushbutton tare cannot be taken when the scale is in motion. If motion is detected when a pushbutton tare command is received, the terminal will wait up to 3 seconds (default value) for a no-motion condition. If a stable (no motion) weight condition occurs before the 3 second timeout (default value) expires, the pushbutton tare command is executed. If there is still motion at the end of timeout period, the command is aborted and a "Tare Failed–Motion" error displays

#### Pushbutton Tare Disabled

If pushbutton tare is configured as disabled, the TARE scale function key  will not initiate a semi-automatic tare.

#### Negative Gross Weigh

Any pushbutton tare attempted when the gross weight is at or below zero is ignored and a "Tare Failed–Below Zero" error displays. Ensure that the gross weight is above zero for tare to be possible.

#### 2.6.2.2 Keyboard Tare

A Keyboard tare, also called a preset tare, is a numeric tare value that is entered manually through the numeric keypad, received serially or via Ethernet from a peripheral device, or retrieved from the Tare Table memory. The preset tare value cannot exceed the capacity of the scale. A manually entered Tare value is interpreted to have the same units as the current displayed value. Motion does not impact the entry of preset tare values.

Keyboard tare can be configured in Setup as enabled or disabled. When disabled, the numeric keypad and the TARE scale function key  cannot be used to obtain a tare.

- To enter a keyboard tare or preset tare value manually, use the numeric keypad or external to enter the tare value (data entered will display just above the softkeys with a “Data:” label) and press the TARE scale function key .

If configured in Setup, remote equipment can enter a Keyboard Tare or Preset Tare value using a serial command or PLC command (refer to [PLC ▶ Page 132] and Communication).

If the Keyboard Tare or Preset Tare is successful, the display changes to a net weight indication, and the entered preset tare value is stored as the tare value in the active tare register. If Tare display is enabled, the pushbutton tare value will be shown with a PT label.

Several conditions could inhibit the keyboard preset or preset tare function:

- Keyboard Tare Disabled** If keyboard tare is disabled in setup, the numeric keypad and the TARE scale function key  cannot be used to obtain a tare.
- Over-Capacity or Under-Zero Conditions** Preset tare is not allowed when the weight display indicates over capacity or under zero conditions. Any preset tare attempted when the scale is over capacity is ignored and a “Tare Failed—Over Capacity” error displays. Any preset tare attempted when the weight display indicates a blanked under zero condition is ignored and a “Tare Failed—Below Zero” error displays.

Preset tare can be entered in free format. If the entered value does not match the displayed weight decimal point location or display interval, the entered tare value is rounded to the nearest display interval and the decimal point adjusted to match the gross weight. The rounding method is that 0.5 or more of a display interval (d) is increased to the next display interval and 0.49 or less of a display interval is decreased to the next lower display interval.

When entering a preset tare value less than 1.0, the operator can enter the data without the leading zero (left of the decimal point), but all subsequent display, storage, or printing of this value will include the leading zero. For example, a preset tare entry of .05 will display as 0.05.

If a preset tare has already been established and another preset tare is entered, the second preset tare replaces the previous value (it does not add to the previous value). The replacement tare can be larger or smaller than the original tare value.

### 2.6.2.3 Special Tare Operation in Multi-interval Scale Applications

When the terminal is configured for multi-interval operation (refer to [# Ranges/Intervals ▶ Page 66]), the terminal only permits a preset tare to be taken in interval # 1. A preset tare, including the recall of a stored tare from the Tare Table (refer to section [Tare Table ▶ Page 35]) must be a value in interval # 1 as well. If a tare is attempted with a weight value found in interval 2 or 3, a “Tare Failed – Over Range” error is given.

**Note: Because of the way the terminal manages the tare, it is required that the final weighing system has a label displayed that indicates the maximum tare value within the capacity of interval # 1: T = nnn, where nnn is the capacity of interval 1.**

The requirements for this marking are as follows:

- Required only for OIML approved terminals that are programmed for multi-interval (not multiple range).
- The descriptive markings shall be indelible and of a size, shape and clarity allowing easy reading.
- It shall be located in a clearly visible place on a sticker fixed permanently to the instrument.
- In case the sticker is not destroyed when removed, a means of securing shall be provided, e.g. a control mark that can be applied

### 2.6.2.4 Tare Table

The terminal contains a tare table with 199 records for storing tare weights that can be quickly recalled by the operator, instead of manually entering them for each transaction. This is especially useful when certain tare values are used repeatedly.

A 20-character description can be included for each record. This description can be used to help distinguish one tare record from another. Each tare record in the tare table also contains a totalization field. When totalization is enabled for the tare table, each time a transaction is completed using a specific tare ID/record, either the gross or net weight value (as selected in Setup) will be added to the record totalization field and the corresponding counter within the tare record will be incremented by one.





A printed report of the records and totalization in the Tare Table is available. [Table and Log File Structure ▶ Page 198] provides additional details about the tare table.

### 2.6.2.5 Loading Records from the Tare Table

The TARE MEMORY softkey  can be used in two ways to active records from the Tare Table.

**Quick Access to Records** When the ID of the Tare Table record to be used is known, use the Quick Recall method. Enter the ID using the numeric keypad and then press the TARE MEMORY softkey  to load the record into the active Tare register/memory. If the record is available, the data is loaded. If the record is not found, an "ID not found" error displays.

**List Selection** When the ID of the Tare Table record is unknown, use the List Selection method. To use the List Selection mode:

- 1 Press the TARE MEMORY softkey  without any preceding data entry. The Tare Search screen displays.
- 2 Enter any search restrictions required or leave selections as they are to retrieve all records.
- 3 Press the SEARCH softkey  to view the selected records in the table.
- 4 Use the UP and DOWN navigation keys to scroll through the list until the desired record is highlighted.
- 5 Press the OK softkey  to load the selected record from the list
- 6 Press the EXIT softkey  to return to the weighing operation screen without loading the record.

### 2.6.2.6 Net Sign Correction

Net sign correction enables the terminal to be used for both shipping (inbound empty) and receiving (inbound loaded) operations. Net sign correction can be either disabled or enabled on the terminal. Refer to [Net Sign Correction ► Page 72] , for further information about disabling and enabling net sign correction.

If net sign correction is disabled in Setup, any stored weight value in the tare register is assumed to be a tare regardless of the gross weight present on the scale at the time of the final transaction and net values can be negative. If net sign correction is enabled, the terminal will switch the gross weight and tare weight fields when necessary, so that the larger weight is the gross weight, the smaller weight is the tare weight, and the difference is always a positive net weight. Net sign correction affects the display, stored data, weight recall, and printed data.

Net sign correction will operate with pushbutton tare, preset tare, or tare records stored in the Tare Table. An example of weight values with and without net sign correction is shown in the table below. In this example, the tare register value is 53 kg and the live weight on the scale is 16 kg.

#### Weight Values with and Without Net Sign Correction

Printed and Displayed	Net Sign Correction	
	Disabled	Enabled
Gross	16 kg	53 kg
Tare	53 kg	16 kg
Net	-37 kg	37 kg

Note: When net sign correction is enabled, the tare weight field in the recall display will be labeled with the letter "M" to indicate "Memory" instead of "T" or "PT".

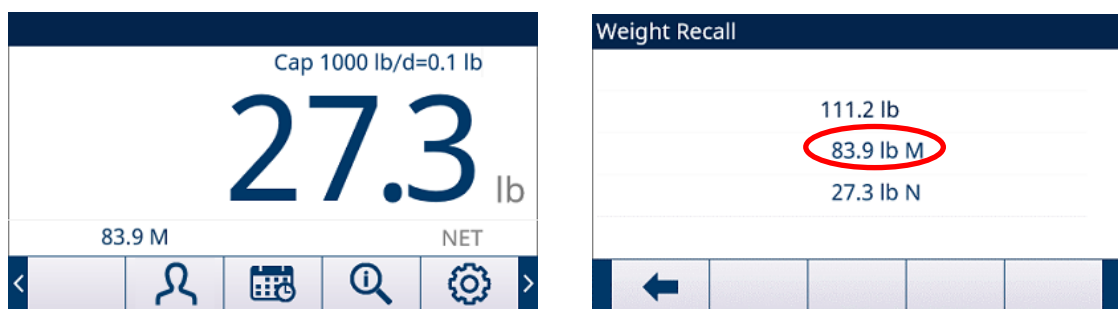

Figure 16: Tare Display with Net Sign Correction Enabled



## See also

 [Net Sign Correction ▶ Page 72](#)

### 2.6.2.7 Auto Tare

The terminal can be configured so that tare is automatically taken (auto tare) after the weight on the scale exceeds a programmed tare threshold weight. Auto tare can be configured in Setup as enabled or disabled. When auto tare is enabled, the display changes to a zero net weight indication after the weight exceeds the threshold value. The previous weight on the scale is stored in the tare register as the tare value.

Auto tare operations involve:

- Tare Threshold Weight** When weight on the scale platform exceeds the tare threshold value, the terminal automatically tares.
- Reset Threshold Weight** The reset threshold weight must be less than the tare threshold weight. When the weight on the scale platform falls below the reset threshold value, such as when a load has been removed, the terminal automatically resets the auto tare trigger.
- Motion Check** A motion check is provided to control the re-arming of the auto tare function. If disabled, the auto tare trigger will be reset as soon as the weight falls below the reset value. If enabled, the weight must settle to no-motion below the reset threshold before the next auto tare can be initiated.

Several conditions could prevent the auto tare function from working:

- Motion** Auto tare cannot be taken when the scale is in motion. If motion is detected after the weight on the scale exceeds a preset tare threshold weight, the terminal will wait for a no-motion condition. If a stable (no motion) weight condition occurs within 3 seconds, the auto tare command is executed.
- Auto Tare Disabled** Auto tare can be configured in Setup as enabled or disabled.

### 2.6.2.8 Clearing Tare

Tare values can be cleared manually or automatically.



#### 2.6.2.8.1 Manual Clear

Press the CLEAR function key  when the terminal is in the net mode and has completed the weighing operation. Motion on the scale will not impact a manual clear.

#### 2.6.2.8.2 Auto Clear

The terminal can be configured to clear tare automatically when the weight returns to a value below a programmable threshold, or when a print command is issued. Once the tare is cleared, the display returns to the gross weighing mode.

Auto clear is disabled or enabled in Setup. If auto clear is enabled the following parameters, configured in Setup, affect the auto clear operation:

- Clear Threshold Weight** The clear threshold weight is the gross weight value below which the terminal will automatically clear a tare after settling to a value above this threshold value.
- Motion Check** A motion check is provided to control the automatic clearing of tare. If the motion check is disabled, the tare value is cleared as soon as the weight drops below the threshold weight (auto clear threshold), regardless of the motion status.  
If the motion check is enabled, after meeting the requirements for weight value above and then below the threshold weight (auto clear threshold), the IND500x waits for a no motion condition before automatically clearing the tare.
- Clear After Print** If enabled, tare is automatically cleared and the scale returned to the gross mode after data has been transmitted by pressing the PRINT scale function key  or from a remote source.
- Clear With Zero** If enabled, pressing the ZERO scale function key  will first clear the tare then issue a zero command.

Refer to [Auto Tare ▶ Page 73] for further information about configuring auto clear.

## 2.6.3 Printing

The print function (demand output) can be initiated by:

- Pressing the PRINT function key 
- Pressing a custom print trigger softkey
- Through the automatic print function

Demand output of data may also be initiated as part of a particular sequence of operation or special application software.

A Printing system message appears for 3 seconds when the terminal is carrying out a demand output command.

### 2.6.3.1 Enabling Printing

To execute a print successfully, a serial, USB or Ethernet connection must be configured with a Demand Output assignment and linked to a template and trigger associated with the selected serial or Ethernet port. If a print command fails because a Demand Output assignment is not programmed on any port, the synchronous error message "Print Failed-No Demand Output" is displayed.

### 2.6.3.2 Print Interlock



Print Interlock is designed to enforce a single demand output per transaction. Print Interlock can be disabled or enabled. If enabled, the print command is ignored until the measured gross weight exceeds the print interlock threshold. After the first print command is executed, subsequent print commands are ignored until the gross weight indication falls below the print interlock reset threshold. If a print command is blocked by print interlock, a synchronous "Print Not Ready" error is generated

### 2.6.3.3 Automatic Print

Automatic initiation of a demand output occurs after the gross weight exceeds the minimum threshold and there is no motion on the scale. After initiation, the gross weight must return below the reset threshold before the next automatic print can occur.



Automatic print may be disabled or enabled. Automatic print can be triggered and reset by weight exceeding set thresholds or by weight deviation from a previously stable reading.

### 2.6.3.4 Repeat Printing

The REPEAT PRINT softkey  permits the data output of the most recent demand output to be printed again with a DUPLICATE header or footer to distinguish it from the original print. To enable the Repeat Print function, simply add the REPEAT PRINT softkey  to the Home Page. Pressing this softkey will initiate a repeat print of the last Demand Output connection listed in the assignments found in [Connections ▶ Page 127].

The repeat output template can be flagged with a "DUPLICATE" header or footer to indicate that the data in the output template was generated as a repeat of a previous communication.

### 2.6.3.5 Custom Print Trigger

The three custom print triggers    available in the terminal can be used to print specific output templates when activated. These custom print triggers will NOT trigger Alibi logging, totalization or transaction counter update. It is recommended that custom print triggers only be used to transmit output templates that do not contain metrologically sensitive data (weight data). However, the user is not blocked from doing so

### 2.6.3.6 Report Printing

To print any of the terminal's standard reports, either through the REPORTS softkey  or from within an application, a serial, USB or Ethernet connection must be configured with a Report assignment. If a report print fails because a Reports assignment is not programmed on any port, the synchronous error message "No Reports Connection" is displayed.

## 2.6.4 Totalization

It is frequently useful for the user of weighing equipment to know how many weighing transactions have been processed and how much material was processed during a particular period of time. Often there is also a need to subdivide this information according to material or item number, customer account, etc. The terminal supports several methods for tracking the number of transactions and processed material. Totalization can occur in the general scale totals register, within the Tare Table and within the Target Table.

### 2.6.4.1 Transaction Counter





A Transaction Counter tracks the total number of transactions processed by the terminal. A transaction occurs when the scale PRINT function is executed directly from the front panel or any of the available remote means (discrete input, PLC or SICS command, etc.) The custom print triggers or duplicate prints do not impact the Transaction Counter.

The Transaction Counter softkey  can be programmed on the Home screen. If Counter Reset is enabled, the transaction counter can be reset to zero through this softkey. The next value for Transaction Counter can be also be cleared or edited in the Terminal branch of setup.

### 2.6.4.2 Grand Total and Subtotal

The terminal provides totalization in both grand total (GT) and subtotal (ST) registers. The total amount of weight processed each time a transaction has completed (PRINT function has been executed) is accumulated in these registers. Each register also has a unique transaction counter. The counters record the number of transactions that have been totalized/accumulated in each register. For details about Grand Total and Subtotal, see [Totalization ▶ Page 104].



### 2.6.4.3 Totals Recall

The Totals Recall softkey , available for assignment to the home screen, displays the sub-total and grand-total transaction counters and total weight for the terminal. Press the CLEAR SUBTOTAL softkey  to clear the sub-total amounts. Press the CLEAR softkey  to clear both the grand-total and sub-total amounts. Press the TRANSFER softkey  to print a report of the totals.

**Note:** If either **Clear Total** or **Clear Subtotal After Print** is enabled in Setup, these values will clear after printing. If security is enabled, Supervisor level log-in or higher is required to execute this PRINT.



## 2.6.5 Unit Switching

In order to support locations and applications that utilize multiple measurement units, the terminal supports unit switching. The UNIT SWITCHING softkey  enables switching between primary units (the main unit of measure) and alternate units (second or third units).

When the UNIT SWITCHING softkey  is pressed, the display changes from the primary unit to the secondary unit. When this softkey is pressed again the display switches to the third unit (if one has been programmed), or returns to the primary unit. Each subsequent time the UNIT SWITCHING softkey  is pressed the terminal continues to switch the unit through the same sequence. When units are switched, the units value changes to the correspondingly selected units, and the conversion of the display value occurs. The display division changes to an equivalent weight value in the switched unit (for example, from 0.02 lb to 0.01 kg) and the decimal location switches to accommodate the conversion.

When switching units, the capacity of the converted units is dictated by the original number of divisions established in the capacity and increments area of setup. In some situations, this may reduce the capacity of the terminal when converting to second or third units.

## 2.6.6 Expand By 10

The EXPAND BY 10 softkey  is used to increase the selected weight display resolution by one additional digit. For example, a weight display of 40.96 could increase by one additional digit to display as 40.958. The Expand By Ten mode is indicated on the display by x10, which displays in the Legend area of the display (see [Understanding the HMI (Human Machine Interface) ▶ Page 23] ). When the EXPAND BY TEN softkey  is pressed again, the display reverts to the normal display of weight. If the terminal is programmed as approved with the metrology switch (SW1-1) ON, the Expand By Ten mode is displayed for five seconds then automatically returns to normal resolution. Printing is disabled when the weight is expanded and the terminal is programmed as approved.

## 2.6.7 Calibration Management

Routine verification of a system’s weighing accuracy is strongly recommended. The terminal provides a method to routinely schedule maintenance and reminder to guarantee the continued accuracy of a weighing system over time. Calibration Management Considers the usage pattern of an equipment to prompt for routine testing, supporting proactive rather than reactive maintenance.

### 2.6.7.1 Service Triggers

A weighing system degrades over time and wears with use. For systems with sporadic heavy use, the number of weighments should determine the test interval while a system that is either lightly used or used in a highly regular fashion might benefit from a time interval as the test trigger.

The terminal offers an elapsed time interval trigger for scale calibration. The exact amount of time between service testing depends on the site specific circumstances, customer expectations, and perhaps on local legal metrology requirements.

### 2.6.7.2 Service Notification

Notification to the user occurs once a calibration service interval has been exceeded. The terminal supports a variety of notification schemes, including:

- System line messages on the terminal display
- Disabling of the scale

The method of clearing or resetting the notification depends on the type of notification. Additional details regarding the setup of Calibration Management, including triggers and notifications can be found in the Section [Calibration Management ▶ Page 138] of Chapter 4, Setup and Configuration.

The overdue display in Home Screen depends on the configuration of On Overdue.

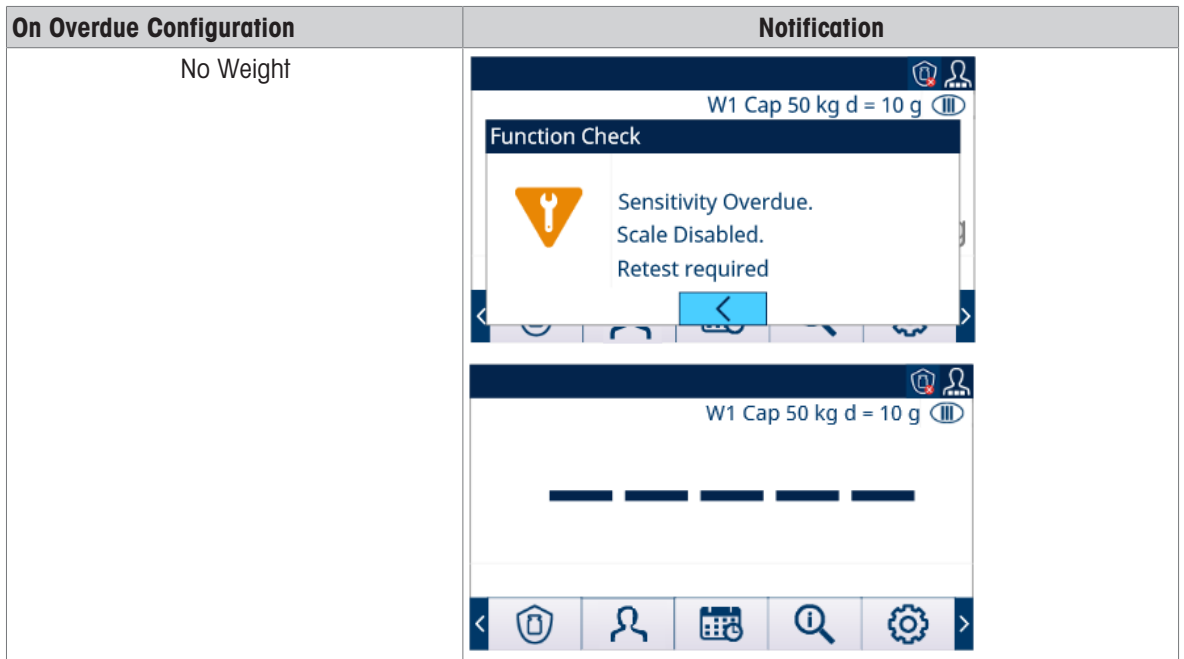

On Overdue Configuration	Notification
No Action	
Orange Weight	



### 2.6.8 MinWeigh

MinWeigh is a METTLER TOLEDO brand for Minimum Weight. The terminal allows the user to set a minimum weight threshold value whereby the terminal will evaluate if the object is too small to be accurately weighed based on the performance of the scale and the customer's process tolerance. In other words, the operator should ideally choose a scale with a lower capacity and a weighing range that more closely matches the accuracy requirements.

In many regions of the world, the minimum weight value is specified by regulations; however a GWP recommendation will determine this value based on the customer's process weighing requirements because in many cases the minimum weight value may be higher than the minimum value specified by legal authorities, based on the process accuracy required by the customer. A GWP Verification is used to confirm this value.

When the MinWeigh function is enabled, the MINWEIGH softkey  on the home screen can be pressed to initiate the normal operation of the MinWeigh function. The MinWeigh function compares the current net weight with the programmed MinWeigh value. If the current net weight is greater than or equal to MinWeigh, all equipment functions behave normally. If the absolute value of the net weight is less than MinWeigh, the weight display includes a flashing MinWeigh symbol . If the user attempts to record the weight while in this condition, the printout will include an asterisk ( \* ) to indicate that the transmitted weight is not valid.

For specific step-by-step instructions on how to set up MinWeigh, refer to [MinWeigh ▶ Page 78].

### 2.6.9 CalFree™

The terminal provides a method to calibrate a scale without using test weights. This is based on manual entry of capacity and performance data from the load cell or load cell platform. This method of calibration can be used for initial check-out and testing of systems or when a large structure is used as the weighing vessel and it is not possible to apply test weights to the structure.

**METTLER TOLEDO strongly recommends that test weights be used whenever possible as this provides the most accurate method of calibration and adjustment. Contact your local METTLER TOLEDO authorized service provider for more information on calibration of the terminal.**

### 2.6.10 Time and Date

Time and date are used for reporting, error and transaction log timestamps, and triggering service events. The TIME & DATE softkey  enables access to the Set Time & Date screen, where the user can set the time and date, including the hours, minutes, day, month, and year. When the time is set, seconds are set to 0.

Although the format for the time and date can be selected according to local preferences, the use of a timestamp in log files is not selectable. Timestamp formats are always fixed as:

**Date:** YYYY/MM/DD (for example, July 20, 2016 becomes the fixed format date 2016/07/20)

**Time:** HH:MM:SS stored in 24 hour format (for example, 10:01:22 PM becomes the fixed format time 22:01:22)

## 2.6.11 ID

The ID function provides a way to collect specific transaction information during a weighing application. Information such as operator, material, purchase order, batch number and similar data can be manually entered through the terminal's alphanumeric keypad, an external keyboard or a barcode scanner. The ID function can also be used to ensure that a specific sequence of operation is carried out the same way every time.

The terminal provides four different ID sequences: ID1, ID2, ID3 and ID4. As many as 30 steps can be programmed in each ID. Some step assignments set up an on-screen message to the user to perform a particular action. Other step assignments cause the terminal to automatically carry out a specific function, such as a Tare. ID assignments are shown below:

<b>Alphanumeric</b>	Allows user to enter freeform data.
<b>Clear Tare</b>	Automatically clears any stored Tare value and returns the scale to gross mode.
<b>Numeric</b>	Allows user to enter data in numeric format only.
<b>Print</b>	Automatically initiates a print. A print connection must be configured in the terminal for the print to execute successfully.
<b>Selection List</b>	Allows the user to select an entry from a pre-programmed dropped down list created within the ID. Up to six selections can be programmed.
<b>Tare – Auto</b>	Automatically executes a Tare.
<b>Tare - Preset</b>	Prompts the user to enter a Tare value. User is required to press ENTER (↵) to accept the Tare.

ID2, ID3 and ID4 can only be triggered manually by an individual softkey. ID1 can be triggered in one of two ways:

<b>Softkey (Manually)</b>	Using the ID1 softkey
<b>Automatically</b>	By threshold and reset weight readings from the scale

If ID1, ID2, ID3 or ID4 is triggered by softkey, it can be programmed to loop, repeating the sequence until either the EXIT softkey  is pressed or an ESC softkey is pressed while an alphanumeric entry field is selected.

When ID1 is set to function automatically, the sequence starts when a weight is placed on the scale that exceeds a programmed threshold value. When all the steps have been performed and the weight is removed, the reading from the scale falls below a reset value. At this point the terminal is ready to begin the next sequence associated with ID1.

For additional details on ID mode configuration, refer to [Terminal ID#1, ID#2, ID#3 ▶ Page 110].

## 2.6.12 Target Comparison

Target comparison is used to compare either the gross or net weight on the scale to a predetermined target value. This feature can be useful in both automatic and manual processes.

As an example, a manual process could be a checkweighing station where an operator checks the net weight of packages. The IND500x can use its target comparison feature to provide a graphic Over - OK - Under indication to help the operator determine if the weight of each package is acceptable or not compared to a programmed target weight.

Target (setpoint) comparison is most often used in two types of applications when no Fill PAC is installed:

- Manual Filling

Manually fill containers with material to target and within the tolerance band.

- Over/Under

Quickly classify a load placed on the scale platform or parameter as OK or above or below an acceptable range.

### 2.6.12.1 Application Entry

The App Entry softkey  in the Home Page provides the only way to run Applications.

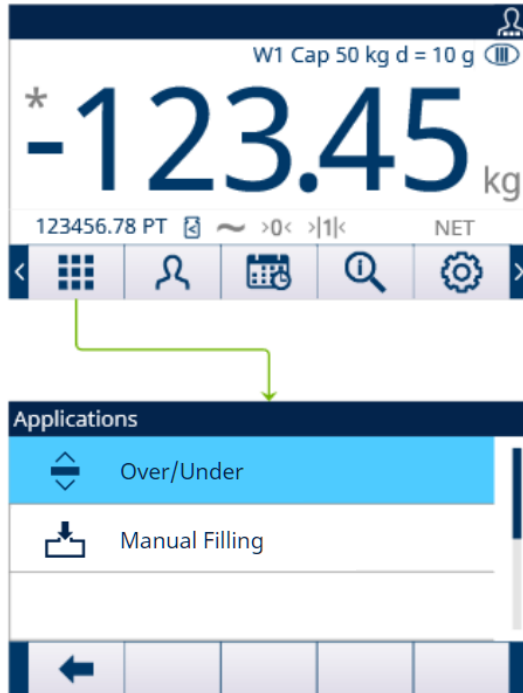







Figure 17: Enter Application via AppEntry

- 1 Press the App Entry softkey  in the Home Page.
  - ➔ The Applications page shows.
- 2 Move the focus with the UP and DOWN navigation keys ( ). Press the EXIT softkey  to go back to the Home Page.
- 3 To select a specific filling mode, press the ENTER key .
  - ➔ The selected filling mode is enabled.

**Attention** The Operator can't switch Application during its running. All Operator changes only can happen within the application.

### 2.6.12.2 Manual Filling

The Manual Filling application is used by customers to manually fill containers with material. No Feeding system is controlled to add weight to or remove weight from scale.

SmartTrac display is used to assist the operator in filling to target, and within the tolerance band.

## Configuration

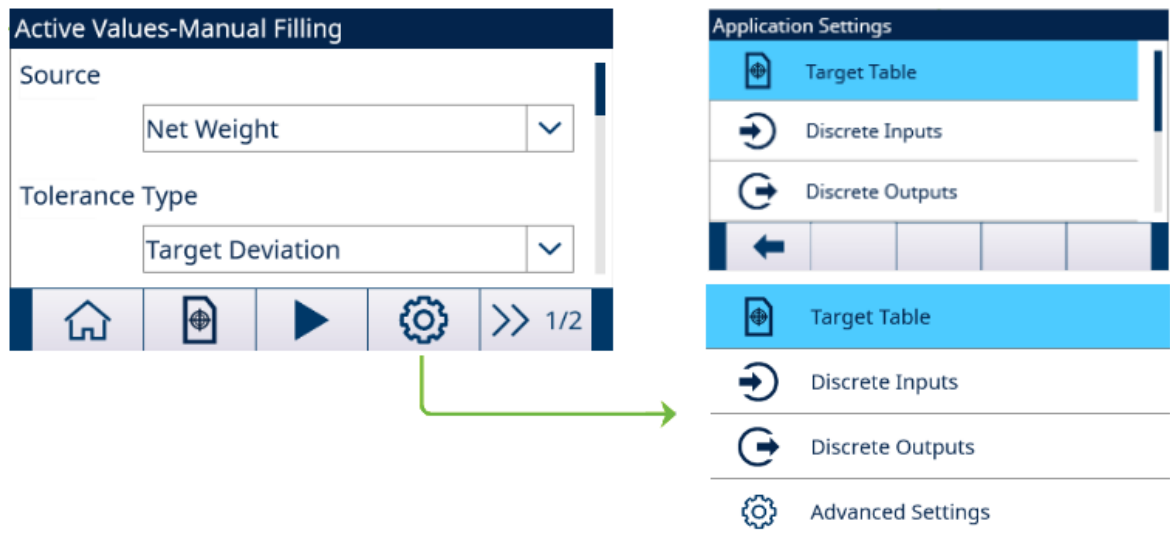

Figure 18: Application Settings

## Operation

SmartTrac™ is used for a graphic display to provide the user with an additional indication of progress of the comparison weight and the target weight.

- No start command is necessary to be issued. Terminal directly and continuously monitors the weight and controls Tolerance Check Outputs and SmartTrac™ Display.
  - ➔ If **absolute value of the weight** < Target - (-Tolerance), Under Zone = Off, Tolerance OK = On, Over Zone = Off.

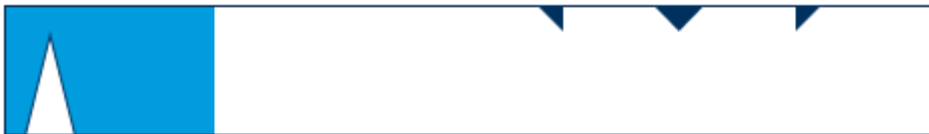

Figure 19: Under Zone

- ➔ If Target - (-Tolerance) ≤ **absolute value of the weight** ≤ Target + (+Tolerance), Under Zone = Off, Tolerance OK = On, Over Zone = Off.



Figure 20: Tolerance OK

- ➔ If **absolute value of the weight** > Target + (+Tolerance), Under Zone = Off, Tolerance OK = Off, Over Zone = On.



Figure 21: Over Zone



### 2.6.12.2.1 Start Filling with Active Target

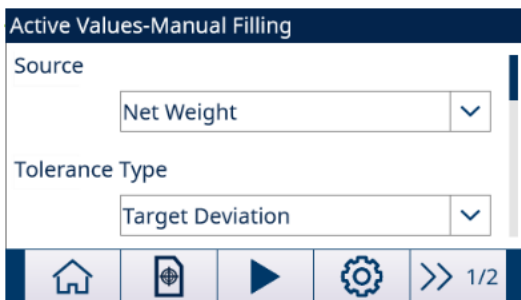

Figure 22: Active Values - Manual Filling

- The Active Values – **Manual Filling** screen shows. Refer to [Application Entry ▶ Page 43].
- 1 Press the UP and DOWN navigation keys (▲▼) to select the specific field and set the Active Values. For definition of each parameter, see Configure the Target Table.



Figure 23: Active Values

- 2 Press the START soffkey (▶).
- ➔ Filling is started with Active Target.

## 2.6.12.2.2 Configure the Target Table

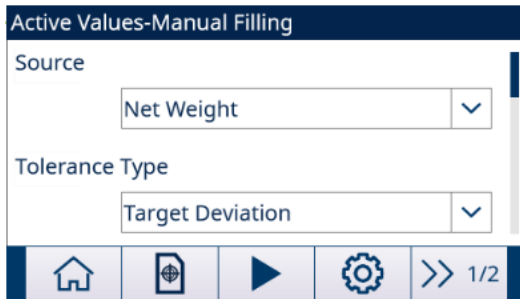

Figure 24: Start-up Screen

### Load A Target Record from the Target Table

#### List Selection







- 1 Press the TARGET TABLE soffkey  in the start-up screen.
  - ➔ The **Target Table** screen shows.



Figure 25: Target Table



- 2 Press the FILTER OFF soffkey .
- 3 In the Filter Settings page, use the selection boxes and data entry fields to enter specific search information to limit the search, or do not enter any search limits to view all Material Table records.
- 4 Press the OK soffkey 
  - ➔ The filtered target records show. Records are ordered by date and time with the most recent record shown last.
- 5 Use the UP and DOWN navigation keys to scroll through the list until the desired record is highlighted. In this screen, user also can press the FILTER ON soffkey  to renew the search information, or press the FILTER CLEAR soffkey  to clear the search information.
- 6 Press the OK soffkey  to load the selected record from the list.
- 7 Press the EXIT soffkey 
  - ➔ A target record is selected.

#### Quick Search







When ID of the Target Table record to be loaded is known, the Quick Recall mode is to be used.



- 1 In the **Target Table** screen, use the numeric keypad to enter the ID and then press ENTER key to load the record.
  - ➔ If the record is available, the data is loaded.
  - ➔ If the record is not found, a message "ID not found" shows.
- 2 Press the OK soffkey 
  - ➔ A record is searched.

#### Create or Add A Target Table Record

- Access Level: Administrator/Supervisor
- Press the EDIT soffkey  to open the setup screen for editing a record or press the ADD soffkey  to open the setup screen to create a new table record.

Parameters Setting for Target Record		
Parameter	Options	Definition or Effect
ID	-	<ul style="list-style-type: none"> <li>ID is the record's serial number identifier.</li> <li>It is unique to replace an existing record with a particular ID number. It must be deleted first, and then a new record can be created with that number entered in the ID field.</li> <li>IND500x can store a maximum of 199 ID records.</li> </ul>
Source	Net Weight	Net Weight is selected as data source for weight comparison.
	Gross Weight	Gross Weight is selected as data source for weight comparison.
Tolerance Type	Target Deviation	<ul style="list-style-type: none"> <li>Target Deviation is measured as an absolute weight value, in the same units as the target value itself.</li> <li>For example, if a target of 100 kg is selected, positive and negative deviations of 5 and 2 kg, respectively, might be defined in the target record, and (unless they are changed) these values will remain fixed regardless of any change to the target value.</li> </ul>
	Percent of Target	<ul style="list-style-type: none"> <li>Percent of Target is measured as a relative value, expressed as a percentage of the target value.</li> <li>In this case, if the target is 100 kg, and the positive and negative tolerances are 5% and 2%, the tolerance band will remain proportionate to the target value even if the target value is changed. Thus, if the record is modified with a new target of 200 kg, the positive and negative tolerances remain 5% and 2%, and represent 10 kg and 4 kg respectively.</li> </ul>
Target	-	The desired measured value for a weighment. Unit: g/kg/lb/t/ton/oz
Tolerance	-	Depending on the Tolerance Type selected, the two tolerance fields, - and +, accept an entry of an absolute weight value, or of a percentage to be applied to the target value.
Description	-	This field allows each target record to have a descriptive identifier. This can be a useful aid when selecting from a list that includes multiple targets, and may note the material involved or the type of vessel into which the feed will be made.
Totalization Type	Net Weight	The Net Weight converted to the unit in the target setting is added to Total.
	Gross Weight	The Gross Weight converted to the unit in the target setting is added to Total.
	Disabled	Totalization for all transactions involving each target in the table will not be tracked.

- 1 Press the UP and DOWN navigation keys ( ) to move the focus to the field name to be edited or inserted.
- 2 Press the ENTER key to select a field value to edit or insert.
- 3 Use the numeric keypad to edit or enter the desired value.
- 4 Press the OK softkey  to accept the modifications or additions to the Target Table.
- 5 Press the EXIT softkey  to return to the previous page without saving modifications or additions.
- 6 Press the DELETE softkey  to delete a target record in the list.
- 7 Press the TRANSFER softkey  to generate Target Table reports to any connection with a Reports assignment.

- 8 Press the RESET softkey  to clear all configuration change records.
  - 9 Press the EXIT softkey  to return to the Target Table page.
- ➔ The **Target Table** is configured.

### 2.6.12.2.3 Configure Discrete I/O

In some circumstances, filling tasks are necessary to be performed without pressing buttons on the terminal's front panel, but controlled by remote devices by configuring discrete inputs or outputs.

- 1 Press the SETUP softkey  in the Active Values – Manual Filling screen.

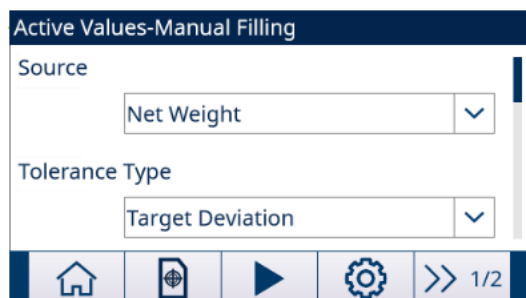



Figure 26: Start-up Screen

- 2 In the Application Settings screen, select **Discrete Inputs** or **Discrete Outputs**.
- 3 In the **Discrete Inputs** or **Discrete Outputs** page, press the EDIT softkey  to open the setup page for editing an existing input or output assignment or press the ADD softkey  to add a new discrete input or output assignment.

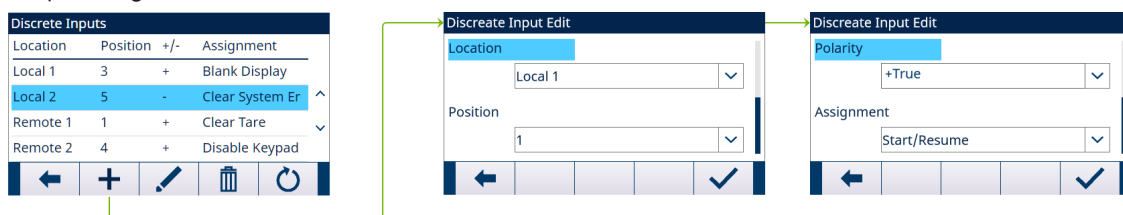

Figure 27: Discrete Inputs

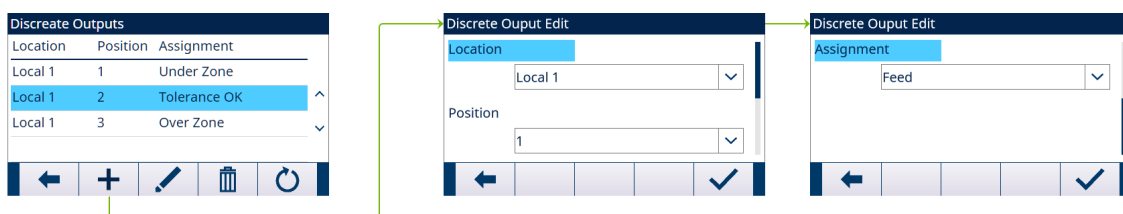





Figure 28: Discrete Outputs

- 4 To select an input or output assignment, refer to the table **Input and Output Assignment Selections**.

Input Assignment Selections	
Input	Effect
Start/Resume	<ul style="list-style-type: none"> <li>• The Start Input is equivalent to START/RESUME softkey .</li> <li>• This parameter can be triggered by 3 ways:               <ul style="list-style-type: none"> <li>– Setting parameter directly.</li> <li>– PLC Command 119</li> <li>– Pressing START/RESUME softkey in Filling directly.</li> </ul> </li> </ul>

Output Assignment Selections	
Output	Effect
Tolerance OK	Active after Tolerance check.
Over Zone	When a new Target comparison starts, all Tolerance check Output (Tolerance OK , Over Zone, Under Zone, Out of Tolerance) will be reset.
Under Zone	

- 5 Press the OK softkey  to confirm the entry.
  - 6 In the **Discrete Inputs** or **Discrete Outputs** page, press the DELETE softkey  to delete a specific input or output assignment and press the RESET softkey  to clear the entire table.
- ➔ The **Discrete I/O** is configured.

### 2.6.12.3 Over/Under

If the target comparison of the IND500x is used to statically check the weight of an item or product, the application can be classified as an Over/Under application. These types of applications are usually manual processes but can also be automated. The SmartTrac display indicates the classification of the weight placed on the scale and discrete I/O can be used to trigger external equipment such as indication lights or reject switches. The terminal compares the current weight to a previously entered target with tolerance values or zone limits and indicates the results.

#### Configuration

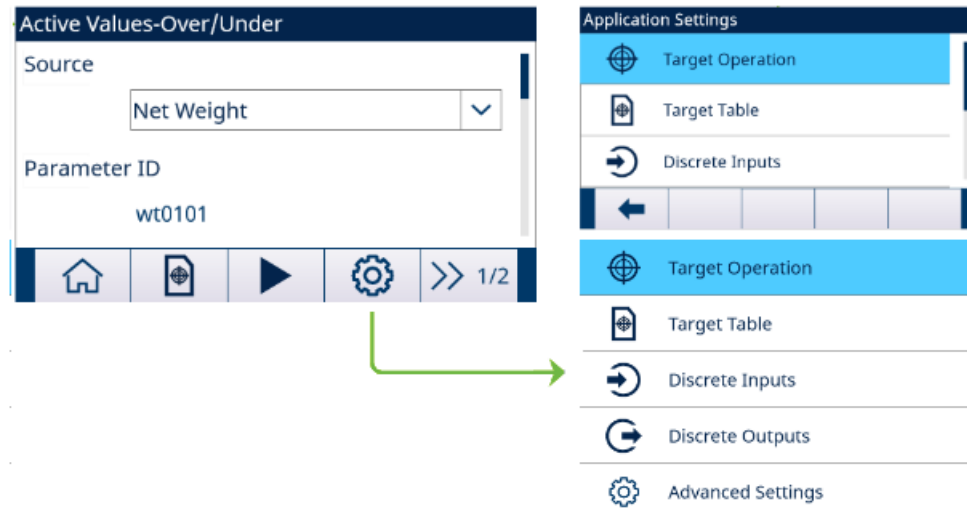

Figure 29: Application Settings

#### Operation

- A target is loaded from the Target Table.
- Load a weight on the scale.
  - ➔ The weight is shown in graphic state on the screen.

#### 2.6.12.3.1 Start Filling with Active Target



Figure 30: Active Values - Over/Under

- The Active Values – **Over/Under** screen shows. Refer to [Application Entry ▶ Page 43].
- 1 Press the UP and DOWN navigation keys (⬆️⬇️) to select the specific field and set the Active Values. For definition of each parameter, see [Configure the Target Table ▶ Page 50].

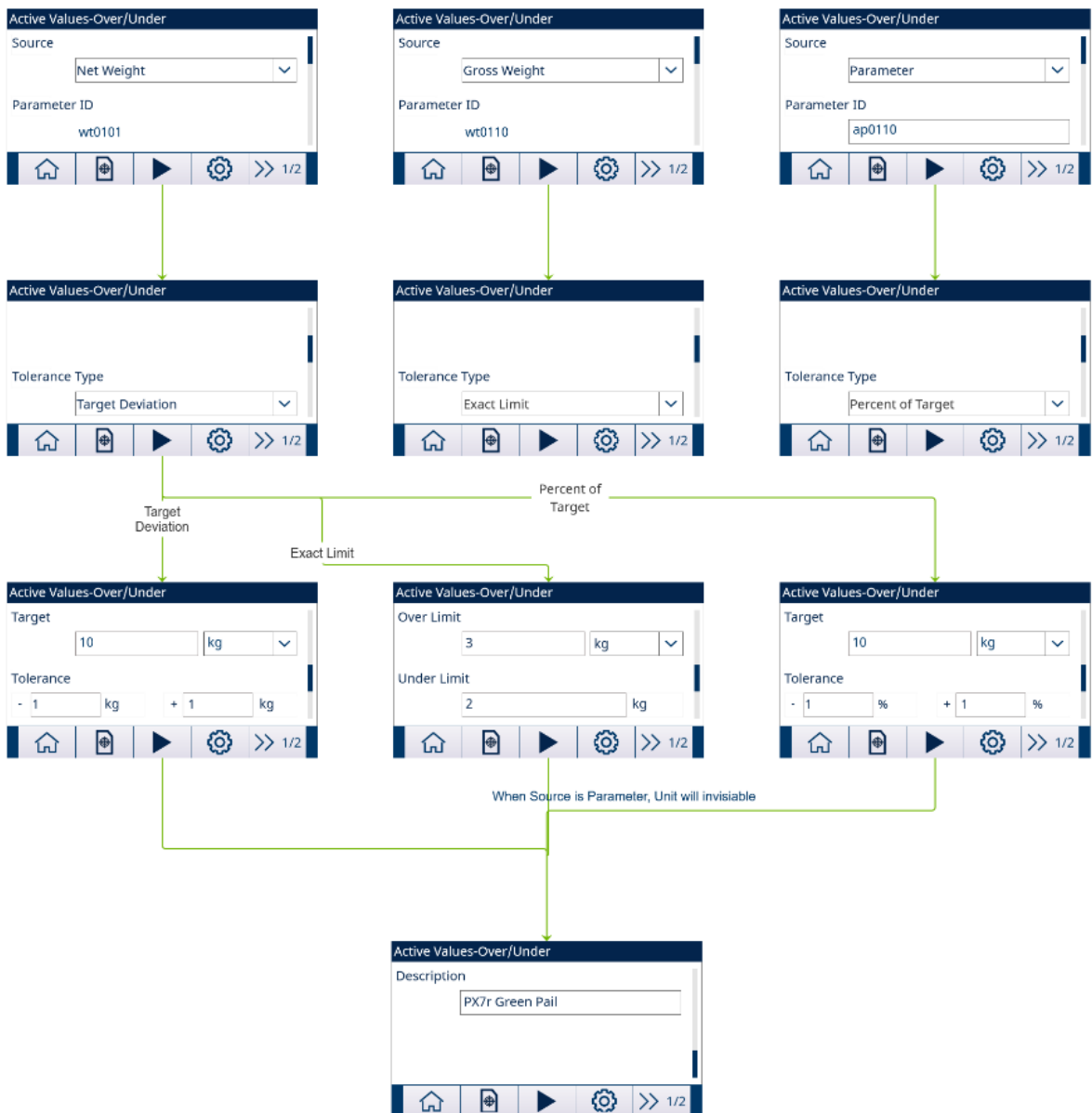

Figure 31: Active Values - **Over/Under**

- 2 Press the START softkey (▶️).
- ➔ **Over/Under** is started with Active Target.

### 2.6.12.3.2 Configure the Target Table



Figure 32: Start-up Screen

## Load A Target Record from the Target Table







### List Selection

- 1 Press the TARGET TABLE softkey  in the start-up screen.
  - ➔ The **Target Table** screen shows.



ID	Description
001	PX7r Green Pail
006	MRRG Blue Pail
007	WOPW Red Pail
008	RKAL Green Pail

Figure 33: **Target Table**



- 2 Press the FILTER OFF softkey .
- 3 In the Filter Settings page, use the selection boxes and data entry fields to enter specific search information to limit the search, or do not enter any search limits to view all Material Table records.
- 4 Press the OK softkey .
  - ➔ The filtered target records show. Records are ordered by date and time with the most recent record shown last.
- 5 Use the UP and DOWN navigation keys to scroll through the list until the desired record is highlighted. In this screen, user also can press the FILTER ON softkey  to renew the search information, or press the FILTER CLEAR softkey  to clear the search information.
- 6 Press the OK softkey  to load the selected record from the list.
- 7 Press the EXIT softkey  to return to the weighing operation screen without loading the record.
  - ➔ A target record is selected.

### Quick Search

When ID of the Target Table record to be loaded is known, the Quick Recall mode is to be used.

- 1 In the **Target Table** screen, use the numeric keypad to enter the ID and then press ENTER key to load the record.
  - ➔ If the record is available, the data is loaded.
  - ➔ If the record is not found, a message "ID not found" shows.
- 2 Press the OK softkey .
  - ➔ A record is searched.









### Create or Add A Target Table Record

- Access Level: Administrator/Supervisor
- Press the EDIT softkey  to open the setup screen for editing a record or press the ADD softkey  to open the setup screen to create a new table record.

### Tolerance Configuration

Tolerance Type	Configuration	Effect
Exact Limits	Over Limit	<ul style="list-style-type: none"> <li>• Maximum acceptable weight classified as OK</li> <li>• Any weight above this value classified as Over</li> </ul>
	Under Limit	<ul style="list-style-type: none"> <li>• Minimum acceptable weight classified as OK</li> <li>• Any weight below this value classified as Under</li> </ul>

Tolerance Type	Configuration	Effect
Target Deviation	Target	Desired measured value for a weighment
	+Tolerance	<ul style="list-style-type: none"> <li>Highest acceptable tolerance above a target value</li> <li>Any weight above weight =Target + +Tolerance) classified as Over</li> </ul>
	-Tolerance	<ul style="list-style-type: none"> <li>Lowest acceptable tolerance below a target value</li> <li>Any weight below weight =Target - (-Tolerance) classified as Under</li> </ul>
Percent of Target	Target	Desired measured value for a weighment
	+Tolerance (%)	<ul style="list-style-type: none"> <li>Highest acceptable tolerance in <b>percent</b> of target above a target value</li> <li>Any weight above weight = Target + +Tolerance *Target/ 100) classified as Over</li> </ul>
	-Tolerance (%)	<ul style="list-style-type: none"> <li>Lowest acceptable tolerance in <b>percent</b> of target below a target value</li> <li>Any weight below weight = Target - (-Tolerance *Target/ 100) classified as Under</li> </ul>

- 1 Press the UP and DOWN navigation keys ( ) to move the focus to the field name to be edited or inserted.
  - 2 Press the ENTER key to select a field value to edit or insert.
  - 3 Use the numeric keypad to edit or enter the desired value.
  - 4 Press the OK softkey  to accept the modifications or additions to the **Target Table**.
  - 5 Press the EXIT softkey  to return to the previous page without saving modifications or additions.
  - 6 Press the DELETE softkey  to delete a target record in the list.
  - 7 Press the TRANSFER softkey  to generate **Target Table** reports to any connection with a Reports assignment.
  - 8 Press the RESET softkey  to clear all configuration change records.
  - 9 Press the EXIT softkey  to return to the **Target Table** page.
- ➔ The **Target Table** is configured.

### 2.6.12.3.3 Configure Target Operation

- 1 Press the SETUP softkey  in the Active Values – **Over/Under** screen.



Figure 34: Start-up Screen



- 2 In the Application Settings screen, select **Target Operation**.
- 3 In the **Target Operation** screen, select to Enable or Disable the **Motion Check** function.

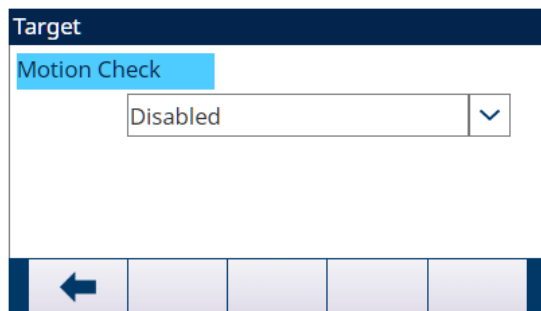

Figure 35: **Motion Check**



- ➔ **Enabled:** The discrete outputs for Over, Under and OK are activated when a no-motion condition is detected.
- ➔ **Disabled:** The discrete outputs for Over, Under and OK shows a dynamic result when the scale is in motion.
- ➔ **Target Operation** is configured.

#### 2.6.12.3.4 Configure Discrete I/O

- 1 Press the SETUP softkey  in the Active Values – **Over/Under** screen.



Figure 36: Start-up Screen

- 2 In the Application Settings screen, select **Discrete Inputs** or **Discrete Outputs**.
- 3 In the **Discrete Inputs** or **Discrete Outputs** page, press the EDIT softkey  to open the setup page for editing an existing input or output assignment or press the ADD softkey  to add a new discrete input or output assignment.

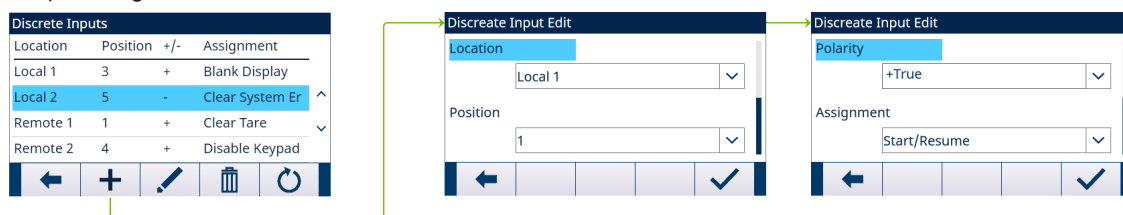

Figure 37: **Discrete Inputs**

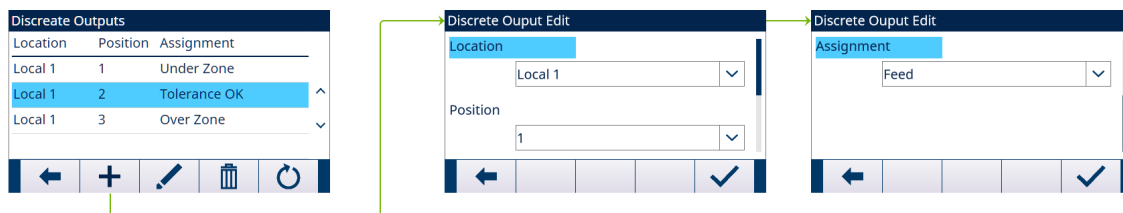





Figure 38: **Discrete Outputs**

- 4 To select an input or output assignment, refer to the table **Input and Output Assignment Selections**.

Input Assignment Selections	
Input	Effect
Start/Resume	<ul style="list-style-type: none"> <li>The Start Input is equivalent to START/RESUME softkey .</li> <li>This parameter can be triggered by 3 ways: <ul style="list-style-type: none"> <li>Setting parameter directly.</li> <li>PLC Command 119</li> <li>Pressing START/RESUME softkey in Over/Under directly.</li> </ul> </li> </ul>

Output Assignment Selections	
Output	Effect
Tolerance OK	Active after Tolerance check.
Over Zone	When a new Target comparison starts, all Tolerance check Output (Tolerance OK , Over Zone, Under Zone, Out of Tolerance) will be reset.
Under Zone	
Out of Tolerance	

- Press the OK softkey  to confirm the entry.
  - In the **Discrete Inputs** or **Discrete Outputs** page, press the DELETE softkey  to delete a specific input or output assignment and press the RESET softkey  to clear the entire table.
- ➔ The **Discrete I/O** is configured.

### 2.6.13 SmartTrac™

SmartTrac™ is a graphic visualization of the weight on the scale, either gross or net weight. SmartTrac™ on the IND500x uses a bar graph visualization type for Filling mode (Basic Auto/Manual/Advanced Auto/Drum Filling) and a three-zone graph visualization type for Over/Under mode.

#### Bar Graph Display

The bar graph display appears to be one continuous display, and can be broken into four separate zones.

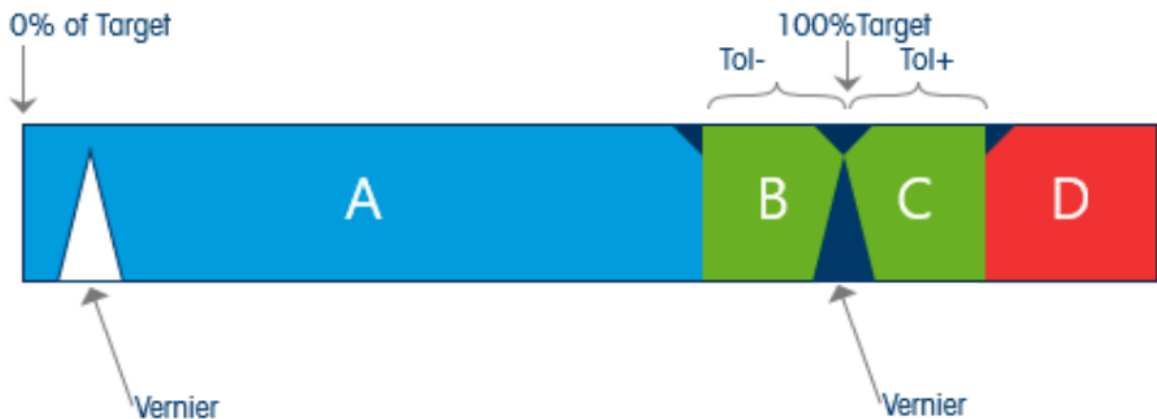

Figure 39: Bar Graph Display

#### Under Zone

Under Zone range is labeled A, with Weight < Target -(Tol-). The bar graph begins to populate the "A" range when more than 0% of the target is added.

#### Tolerance OK

In the range from Target - (Tol-) to Target + (Tol+), the zone of acceptable tolerance below the target value is labeled B, while the zone of acceptable tolerance above the target value is labeled C.

#### On Target

The measured value exactly equals the target value.

#### Over Zone

Over Zone is labeled D, and it represents the zone of unacceptable tolerance above the target value and more than Tol+.

#### Rate of Bar Graph Fill

In a filling operation, material is weighed into a vessel on the scale (or dosed out of a vessel on the scale) until the measured weight is within an acceptable tolerance limit. Typically, material is added quickly when the container is closer to empty and more slowly as the measured weight on the scale approaches the desired target value. This is especially true in manual filling and batching operations. To help maintain a good dynamic range in both regions (closer to zero and near to target), the rate at which the SmartTrac™ fills in is different for the various sections of the bar graph.

In most filling applications, sections A and D appear to fill in at much slower rate than sections B and C. This is because sections A and D usually represent a much larger weight range, while sections B and C typically represent only a few increments. The overall proportion of bar graph fill rate to weight gain is much higher in sections A and D.

When the bar graph fill reaches section B, the SmartTrac™ appears to move very fast toward the target. This is an important concept to understand for proper operator training. The operator must understand that when SmartTrac™ is used during a manual filling process, the rate of material addition to the scale must slow down as the graph approaches section B, or the target and upper tolerance values will quickly be exceeded.

### **Vernier**

A Vernier is implemented as part of the bar graph. The Vernier is shown as a triangle in bar graph that moves at a consistent rate at an expanded sensitivity range to help an operator judge the final value more accurately during a manual fill. It moves from left to right across the top of the bar graph.

- When the measured value is at zero, the Vernier does not show.
- When the measured value reaches a threshold value large enough that the number of dot columns for the Vernier range is met, the unfilled Vernier shows and begins to move right in the bar graph. In section B, the Vernier moves at 1/3 of the bar graph rate, and its rate/weight proportion remains constant while it is shown.
- When the measured value equals to the target value, the Vernier turns from unfilled triangle into filled triangle.
- When the measured value continues increasing, the Vernier reverts into unfilled triangle, and then moves right in the bar graph.
- If the measured value exceeds the maximum value where the Vernier would be not shown at the right edge of the display, the Vernier disappears at the far right edge of the display. If the measured value is reduced, the Vernier shows again.

## **2.6.14 Comparators**

The five Comparators in IND500x are simple, non-latching setpoints used to compare the active weight (or rate) value with an absolute target (or rate) value or a defined weight range. The source for the comparison can be Application related or Weight related.

Comparators are controlled either by coincidence (either below or above an absolute target value) or by comparison with a range. The Operator setting within Comparator setup determines the control mode in which a Comparator operates.

- When the Operator setting is  $<$ ,  $\leq$ ,  $=$ ,  $<>$ ,  $\geq$  or  $>$ , the selected source (weight or rate) is compared to a single target value.
- When the Operator value is  $>\_ \_ <$  (within a range) or  $\_ <> \_$  (outside a range), the selected source (weight or rate) is compared to a range defined by (low) Limit and High Limit values.

The Comparator softkey  permits direct viewing and editing of the Comparators from the home screen.

### **Comparators and Discrete Outputs**

Comparators are intended to be used with discrete outputs. The function of a comparator is to trigger a discrete output based on the parameters of the comparator. Each comparator in the IND500x has an assignable discrete output that will activate when the comparator's settings are met. Refer to Chapter [Application ▶ Page 99] for more information on the setup and use of comparators with discrete I/O.

### **Target Value Comparators**

The assigned discrete output for a Target Value (coincidence) comparator is triggered when the selected source is TRUE in regards to the selection in the comparator's Operator setting.

#### **Example:**

- Source: Rate.
- Operator:  $\leq$  (less than or equal to)

- Limit: 100 kg/min

The output is ON when the rate is under 100 kg/min and turns OFF when the measured value reaches 100 kg/min.

### Range Comparators

In the case of a Range mode Comparator, the assigned output is triggered when the selected source is TRUE in regards to the Operator setting(s). The Limit setting establishes the lower of the two values that define the range. The High Limit setting defines the upper value of the range.

#### Example:

- Source: Gross Weight
- Operator: >\_ \_< (within a range)
- Limit: 300 kg
- High Limit: 800 kg

The output is ON when the measured gross weight is between 300 and 800 kg. If the weight falls below 300 kg or exceeds 800 kg, the output turns OFF.

#### Example:

- Source: Gross Weight
- Operator: \_><\_ (outside a range)
- Limit: 200 lb
- High Limit: 400 lb

The output is ON when the measured gross weight is 200 lbs or less and 400 lbs or higher. If the gross weight measures between 201 lbs and 399 lbs, the output turns OFF.

## 2.6.15 Alibi Memory Direct Access

The Alibi Memory stores individual transaction data that can be retrieved for verification purposes. Information stored in the Alibi Memory includes:

- Transaction counter value
- Date and time of transaction
- Gross, net, and tare weights including units of measure



### NOTICE

**If the IND500x terminal has been programmed as "approved", Alibi memory enabling or disabling is only accessible if the security switch (SW1-1) is in the OFF position.**

**The Alibi memory can not be cleared unless a Factory Reset is implemented. Refer to PCB Switch Settings for more information on Factory Reset.**

### 2.6.15.1 Creating Alibi Memory Record

Alibi memory records can be created automatically or manually:

- **Auto Print:** Through an automatic initiation of a demand output print request
- **Semi-automatic Print - Pushbutton:** Through pressing of a scale key which specifically designated for printing.
- **Semi-automatic Print - Remote:** Through a printing command initiated via a discrete input, an ASCII P serial command or a PLC interface.





### 2.6.15.2 View and Print Alibi Memory

- 1 Press the VIEW TABLE softkey .

➔ The Alibi screen displays.

Alibi			
Date	Time	Transaction	Gross W
04-Aug-2020	11:06:25	0000003	6.35
04-Aug-2020	11:07:25	0000004	13.98
04-Aug-2020	11:08:25	0000005	13.55
04-Aug-2020	11:09:02	0000006	2.20

Figure 40: Alibi

- 2 Press the FILTER OFF softkey .
- 3 Use the selection boxes and data entry fields to enter specific search information to limit the search, or do not enter any search limits to view all Alibi Memory Table information.
- 4 Press the OK softkey .
  - ➔ The filtered search results are shown. Records are ordered by date and time with the most recent record shown last.
- 5 Use the navigation keys to view the records: Date, Time, Transaction, Gross Weight, Net Weight, Tare Weight, Preset Tare, and Unit. Note: In the column of Preset Tare, "PT" is shown if the transaction uses a preset tare. In this screen, user can press the FILTER ON softkey  to renew the search information, or press the FILTER CLEAR softkey  to clear the search information.

Date	Time	Transaction	Gross Weight	Net Weight	Tare Weight	Preset Tare	Unit
04-Aug-2020	11:06:25	0000003	6.35	6.00	0.35		kg
04-Aug-2020	11:07:25	0000004	13.98	13.00	0.98	PT	kg
04-Aug-2020	11:08:25	0000005	13.55	13.00	0.55		oz
04-Aug-2020	11:09:02	0000006	2.20	2.20	0.00		Custom

Figure 41: Records

- 6 Press the TRANSFER softkey  on this screen to print the entire selected Alibi Memory Table.

## 2.7 Information Recall

User can press the Information Recall softkey  in the Home Page to access the Recall screen.

Recall	
Model:	IND500x
S/N:	B1232477868
IP:	192.168.0.15

Figure 42: Information Recall

If no Network, IP does not show on the screen.

### Weight Recall

- Press the Weight Recall softkey .
  - ➔ The Weight Recall page shows, indicating the Gross Weight, Tare Weight, and Net Weight.

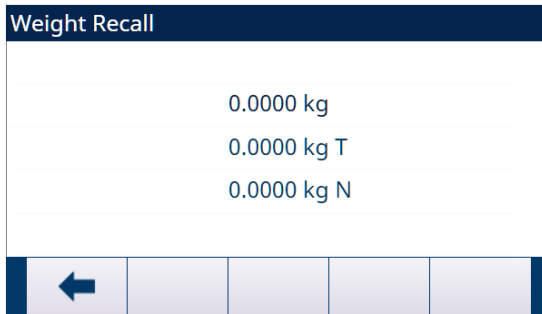

Figure 43: Weight Recall

### System Information Recall

- 1 Press the System Information Recall softkey .
  - ➔ The System Info Recall page shows with system information.

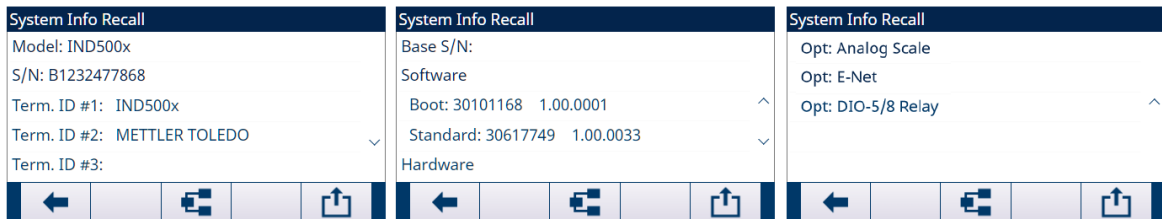

Figure 44: System Information Recall (Analog)

- 2 Press the Connected Devices softkey to show peripheral device information that has been manually entered by the service provider or user. See [Connected Devices ▶ Page 111]

### Metrology Recall

- Press the Metrology Recall softkey .
  - ➔ The Metrology Recall page shows the terminal metrology control number (MCN), whether the terminal is programmed as approved or not, along with the last calibration date and time.

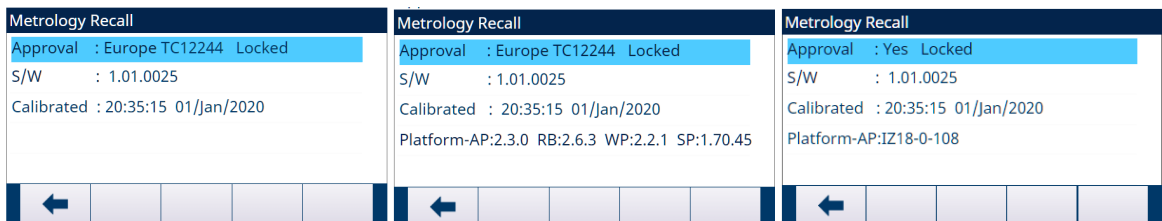

Figure 45: Metrology Recall screen of Analog (left), SICSpro (middle), or IDNet (right) scale

### TaskExpert™ Checksum

If TaskExpert™ is installed in the terminal, the TaskExpert™ Checksum softkey will appear on the Metrology Recall screen. The TaskExpert™ Checksum softkey displays the terminal calculated checksum for the custom application that has been loaded into the terminal. This calculated checksum is compared to the checksum embedded in the TaskExpert™ application. A match must occur for the application to run.

### Service Information Recall

- 1 Press the Service Information Recall softkey .
  - ➔ The Service Information Recall page shows the service provider contact information.

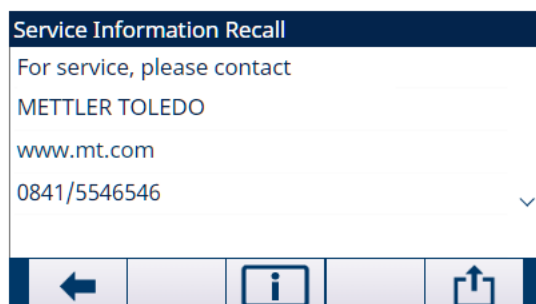





Figure 46: Service Information Recall

- 2 Press the Terminal Status softkey  to show the Terminal Status Report page, where additional system performance details are available.

Terminal Status Report			
Status	Report Category	Value	
	Scale Excitation	4.8V	4.8V
	Signal Quality	80.0	
	Current SDS Logins	0	▼
	Total Weighments	15	







Figure 47: Terminal Status Report (Analog)

- 3 Press the TRANSFER softkey  to transmit a comprehensive report via any communication connection with a Reports assignment.

## 3 Setup and Configuration

### 3.1 Entering Setup Mode

- 1 To enter the Setup mode, press the SETUP softkey  when the terminal displays the default weighing operation screen.
- 2 The Setup menu tree displays. Most of the Setup menu is viewable by any user at any time.
- 3 If user security has been enabled and a user is attempting to enter Setup for the purpose of modifying terminal configuration, go to the Home Page and Press the LOGIN softkey . See also [Accessing Setup and Terminal Functions ▶ Page 21].

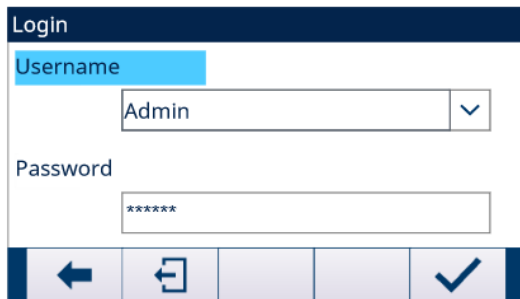









Figure 48: Login Screen

If user presses the LOGOUT softkey , the Default User is logged in.

#### 3.1.1 To Enter a Username and a Password

- 1 Press  to access the **Username** entry box. The current data entry mode is identified at the right of the top line (see Login Screen). Refer to [Data Entry ▶ Page 30] for details on entering alphanumeric characters.
- 2 Use the keypad or external keyboard to enter the user name in the Username entry box. This field is case sensitive.
- 3 Press .
- 4 With focus on the **Password** field label, press  and focus moves to the Password entry box.
- 5 Use the keypad or external keyboard to enter the password in the Password entry box. This field is case sensitive. Note that asterisks are shown instead of the actual character entered.
- 6 Press .
- 7 After both the username and password have been entered, press .
  - ➔ If the username and password are correct, the terminal goes into Setup mode and the Setup menu tree displays.

### 3.2 Exiting Setup Mode

- 1 To exit the Setup mode, select **Home** from the Setup menu tree and then press .
  - ➔ The default weighing operation screen displays.
- 2 As a quick alternative, press the far left softkey  whenever the Setup menu tree is displayed to exit the Setup mode. If no other function is indicated on the far left softkey, it will typically function as an EXIT softkey .

### 3.3 Logout

There are two ways to Logout:

- Logout by timeout of Auto Logout
- Logout manually

#### Auto Logout

If Auto Logout is enabled, the time will be remembered while login and terminal checks if timeout is expired periodically. If timeout is expired, the active user will log out and default user will log in.

For more details about this function, see [Auto Logout ▶ Page 115] in chapter Configuration>Terminal.



## Logout Manually

- 1 Press the LOGIN softkey  in the Home Page.
  - ➔ The Login page shows with the Active User.

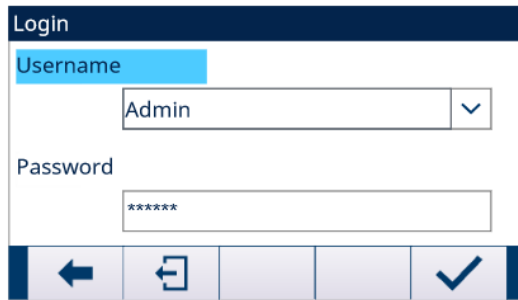



Figure 49: Login

- 2 Press the LOGOUT softkey .
  - ➔ The Active User is logged out.

### After Logout

If default user has empty password and logout happens (manual or auto), terminal directly logs in the default user without requiring a password.

If default user has password and logout happens, a Login page shows to require password entry.

## 3.4 Setup Menu Tree

Each line of the setup menu tree is referred to as a branch (see [Setup Menu Tree ▶ Page 61]). Some branches have additional sub-branches that become visible when the view of the main branch is expanded. If a branch has sub-branches, the collapsed symbol ( + ) initially displays in front of the branch name. After the branch view has been expanded, the expanded symbol ( - ) displays in front of the branch name and the additional branches become visible. Any branch that is not expandable is called a leaf node.

The first branch of the menu tree shown with focus is the Scale branch ([Setup Menu Tree ▶ Page 61]).

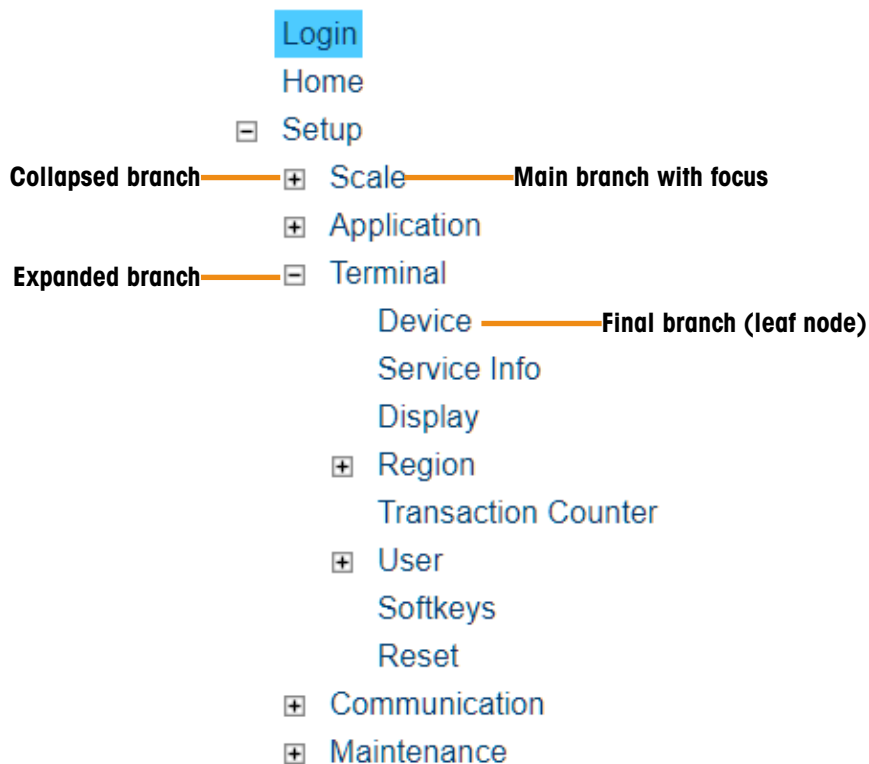







Figure 50: Setup Menu Tree

Use the UP and DOWN navigation keys ( ) to move focus through the branches of the Setup menu tree. Press the RIGHT navigation key  to expand a branch and the LEFT navigation key  to collapse a branch. When the focus is on a sub-branch, focus can quickly be moved back to the main branch by pressing the LEFT navigation key .

When a leaf node (singular, non-expandable) branch such as Device or Display is in focus, pressing the ENTER key (↵) will display the setup screen for that function.

### 3.4.1 Setup Screens

Setup screens enable access to data fields where parameters can be viewed, entered, or modified to configure the terminal to meet specific application function needs.

#### 3.4.1.1 Navigation

Press the UP and DOWN navigation keys (⬆️⬇️) to move through the field labels displayed on each setup screen, and to move to a second or third setup screen when more than one screen is used for configuration fields associated with a specific parameter (indicated by the presence of a scroll bar). The shaded portion of the scroll bar (see figure below) indicates which screen is displayed.

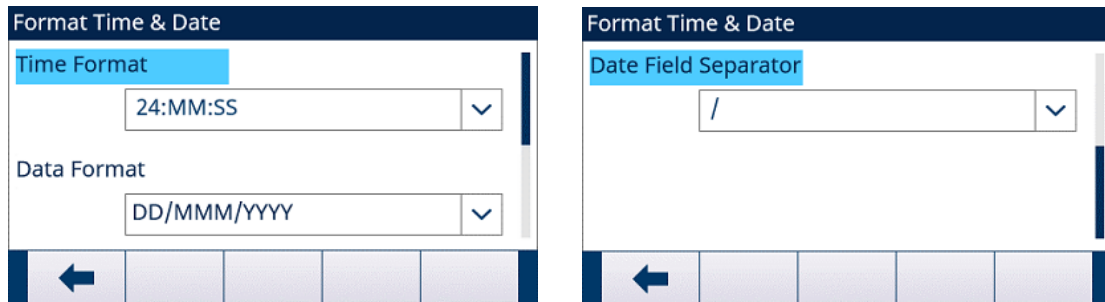

Figure 51: Examples of Setup Screens (Format Time & Date)

#### 3.4.1.2 Data Entry

Press the ENTER key (↵) to move the focus from the field label to either the selection box or data entry box where data is to be entered to edited (see figure below).

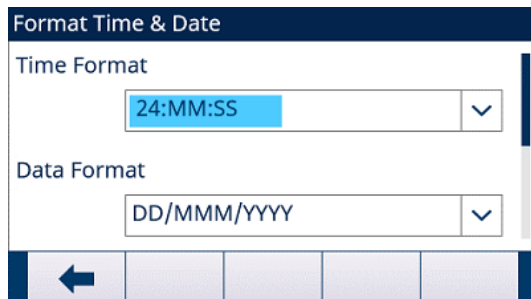

Figure 52: Setup Screen

If the field values are presented in a selection box, the current selection will have focus when the ENTER key (↵) is pressed.

##### 3.4.1.2.1 To Change the Field Value in a Selection Box

- 1 Press the UP and DOWN navigation keys (⬆️⬇️) to scroll through the list and place the focus on the value to be selected. Note that when viewing the last field in a selection box, pressing the DOWN navigation key (⬇️) again will move the focus to the top of the selection list. When viewing the first field in a selection list, pressing the UP navigation key (⬆️) will move focus to the last selection.
- 2 Press the ENTER key (↵) to accept the selection as the value for the field. The selection displays as the value for the field and the focus moves to the next field label.
- 3 To exit a setup screen, press the EXIT softkey (⬅️) (the far left softkey).
  - ➔ The Setup menu tree displays with the focus on the branch for the setup screen that was exited.

### 3.4.1.2.2 To Change the Field Value Using Alphanumeric Characters

- 1 When a data entry box is first entered, the previous data (if present) is in focus. To replace previous data, use the alphanumeric keypad to enter the desired value; Or press the LEFT and RIGHT navigation keys (◀▶) to move the cursor into position if the value needs to be edited from a specific point rather than replaced. Position the cursor at the end of the data to be deleted and press the C key © once for each character to be deleted.
- 2 Press the ENTER key ↵ to accept the entered alphanumeric characters for the field. The entry displays as the value for the field and the focus moves to the next field label.
- 3 To exit a setup screen, press the EXIT softkey ← (the far left softkey).
  - ➔ The Setup menu tree displays with the focus on the branch for the setup screen that was exited.

## 3.5 Overview of Configuration

The Setup menu tree can be expanded to show every branch and leaf node in the terminal's configuration. Use the navigation keys to select the desired setup screen.

The Setup menu tree includes the following major branches:

- Scale
- Application
- Terminal
- Communication
- Maintenance

Note: The presence of Setup menu branches depends on installed options and, in some cases, configuration selections made in other areas of setup. For example, the TaskExpert branch is only available if the optional TaskExpert software module has been installed into the terminal.

## 3.6 Scale

**Note: if the Metrology switch is in the approved position (SW1-1 = ON), changes to protected parameters in the Scale branch are not permitted.**

The Scale branch provides the following access to the configuration of the connected scale:

Note: Leaf nodes that are marked with an asterisk (\*) above will have different parameters depending on the connected scale type.

Each type of scale in the terminal offers different parameters in the Scale branch. To simplify the scale programming process, each scale type is described in a separate section in this chapter. Refer to the correct section for the type of scale used.

- Analog Scale Interface Refer to [Scale - Analog ▶ Page 64].
- IDNet Scale Interface Refer to [Scale - IDNet ▶ Page 81].
- SICSpro Scale Interface Refer to [Scale - SICSpro ▶ Page 92].

### 3.6.1 Scale - Analog

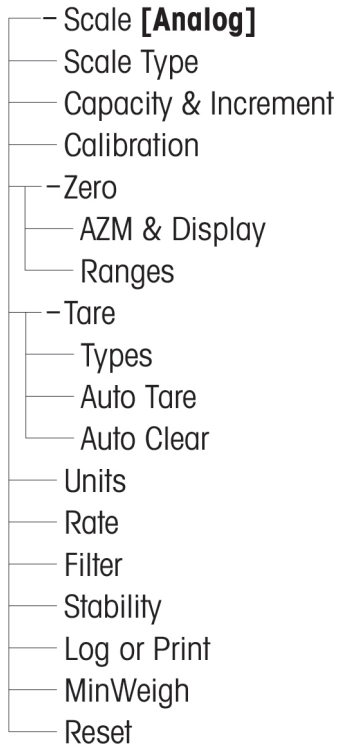

Figure 53: Setup Menu of Scale - Analog

#### 3.6.1.1 Scale Type

The Scale Type screen permits a name to be assigned to the scale, displays the scale PCB type in the terminal, provides a selection list for the Approval mode, and allows entry of the approval class and interval for the metrology line.

##### 3.6.1.1.1 Name

The Name field enables entry of the scale identification. Enter the scale name (an alpha-numeric string of up to 20 characters) in the Name entry box.

Default: **Scale 1**

##### 3.6.1.1.2 Scale Type

The Scale Type field indicates which type of scale this terminal supports.

Available option (s):

**Analog** [default for analog version]

##### 3.6.1.1.3 Approval

Approval refers to the metrological (weights and measures) approval configuration for the specific scale.

Available option (s):

**None** [default], USA, OIML, Canada, Australia, Argentina, Thailand, Korea

If the approval is configured as USA, OIML, Canada, Australia, Thailand or Korea and the Metrology Switch, SW1-1, is set to ON, access to the Scale setup parameters in the menu tree will be limited to view only.

Note that when OIML is selected and the ENTER key  is pressed, the Approval selects OIML and, at the same time, the metrology line will show "Max/Min/e" (see figure below) and default values of legally relevant parameters will change accordingly.

Legal Relevant Parameters	Factory Default Value	OIML Default Value
Scale (Analog)   Capacity & Increment   Blank Over Capacity	5 d	9 d

Legal Relevant Parameters	Factory Default Value	OIML Default Value
Scale (Analog)   Zero   AZM & Display   Auto Zero Range	0.5 d	0.5 d
Scale (Analog)   Zero   AZM & Display   Under Zero Blanking	5 d	20 d
Scale (Analog)   Zero   AZM & Display   Power Up	Restart	Reset (When Approval selects OIML, select Restart if Power Up Zero is disabled, or Reset if Power Up Zero is enabled)
Scale (Analog)   Zero   Ranges   Power Up Zero	Disabled	Enabled
Scale (Analog)   Zero   Ranges   Power Up Zero Range	+0%, -0%	+18%, -2%
Scale (Analog) >Tare> Auto Clear>Power Up	Restart	Reset



If the approval is configured as Argentina and the Metrology Switch, SW1-1, is set to ON, changes to metrologically significant areas in the menu tree is prohibited. If an attempt is made to change any metrologically significant parameter, the onscreen message "Access defined. Scale is Approved." appears.

If an approval is selected but SW1-1 is not ON, it will not be possible to leave Setup, and the message "Switch UNSECURED" appears.



## NOTICE

**After setting the terminal to approved, and before exiting Setup, SW1-1 should be switched to ON. Take care when setting the switch in the powered terminal.**

### 3.6.1.1.4 Class

The Class field selection is shown if the scale terminal is selected as approved. This selection must match the Weights and Measures approval class when the terminal is used in an approved mode. The Class information is included in the data shown in the metrological line at the top of the display.

Available option (s):

II, III [default], III HD, III L, IIII

### 3.6.1.1.5 Verified Interval

Verified Interval shows only when the scale is approved and Class has been selected as II.

The Verified Interval indicates if the approved increment size is equal to the displayed increment size or if it is 10 times the displayed increment size. This information is included in the data shown in the metrological line at the top of the display.

Available option (s):

e=d [default], e=10d

### 3.6.1.1.6 Power Up Delay

Power Up Delay only appears when the Approval on an analog scale has been set as "OIML". This parameter supports approval to the most stringent performance requirements of the European MID.

Settings for Power Up Delay include:

**Disabled** [default], Enabled

When enabled, operation of the terminal is prohibited (except for Setup access) until 5 minutes have expired. A process timer is provided in the terminal system line, and updates every 3 seconds.

It is strongly recommended to leave Power Up Delay disabled (default condition) unless the application/installation requires MID R61 approval for automatic gravimetric filling.

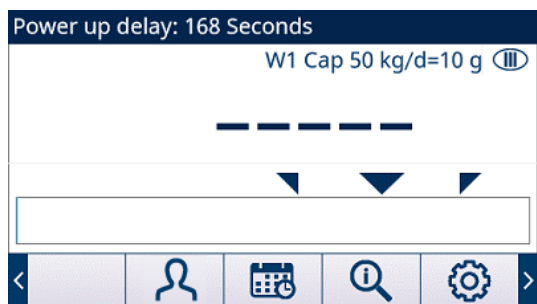

Figure 54: Power Up Delay Shown in System Line

### 3.6.1.2 Capacity & Increment

Use the Capacity and Increment setup screen to select primary units, set the number of ranges or intervals, program the capacity and increments sizes, and the blanking over capacity value.

#### 3.6.1.2.1 Primary Units

Set the primary units from the selection box choices.

Available option (s):

grams (g), **kilograms (kg)** [default], pounds (lb), tonnes (t), tons (ton)

#### 3.6.1.2.2 # Ranges/Intervals

Select the multi-interval or multiple range mode and set the number of ranges or intervals from the available options.

Available option (s):

1 [default], 2 intervals, 2 ranges, 3 intervals, 3 ranges

#### >| 1 |< - Range/Interval 1 Values

Specify the capacity and then the increment size for range or interval 1.

#### >| 2 |< - Range/Interval 2 Values

When more than one range is selected, these parameters provide entry of the capacity and then the increment size for the second range or interval.

#### >| 3 |< - Range/Interval 3 Values

When three ranges or intervals are selected, these parameters provide entry of the capacity and then the increment size for the third range or interval.

#### 3.6.1.2.3 Blank Over Capacity

Blanking of the display is used to indicate an over-capacity condition. Set the blank over capacity for the number of display increments that the terminal is permitted to go over capacity. For example, if capacity is set at 500 kg by 0.1 kg increments and the blank over capacity setting is 5 d, the terminal can display weights up to 500.5 kg. At weights over 500.5, dashed lines (-----) will display instead of a weight and demand data output is inhibited.

The factory default of Blank Over Capacity is **5 d**, and OIML default is **9 d**(refer to [Approval ▶ Page 64] for more information).

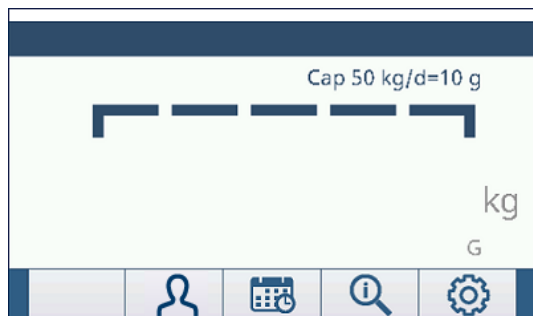



Figure 55: Overcapacity Dashed Lines

### 3.6.1.3 Calibration

The Calibration screens enable entry of a geo code, the base serial number, calibration units, linearity adjustment. This screen also provides access to the Service Mode (  ) of an IDNet scale.

#### 3.6.1.3.1 Geo Code

Enter the geo code for the appropriate geo adjustment value for the current geographical location. Geo codes are numbered 0 - 31. Refer to [Geo Code Table B ▶ Page 233] to find the appropriate Geo Code for the installation location.

Default: **16**

#### 3.6.1.3.2 Base Serial Number

If appropriate, enter the connected scale base serial number in this field. An entry of up to 14 characters is possible.

#### 3.6.1.3.3 Calibration Units

Calibration units are the same as the primary units selections.

Available option (s):

grams (g), **kilograms (kg)** [default], pounds (lb), tonnes (t), tons (ton)

#### 3.6.1.3.4 Linearity Adjustment





Select the linearity adjustment from the selection box.

Available option (s):

<b>Disabled</b> [default]	Use only zero and one span point (test load #1)
3 point	Use zero, midpoint (test load #1), and highpoint (test load #2)
4 point	Use zero, lowpoint (test load #1), midpoint (test load #2), and highpoint (test load #3)
5 point	Use zero, lowpoint (test load #1), midpoint (test load #2), mid-highpoint (test load #3), and highpoint (test load #4)
3 point with Hysteresis	Use zero, midpoint (test load #1), and highpoint (test load #2), then unload to midpoint (test load #1)
4 point with Hysteresis	Use zero, lowpoint (test load #1), midpoint (test load #2), and highpoint (test load #3), then unload to midpoint (test load #2) and lowpoint (test load #1)
5 point with Hysteresis	Use zero, lowpoint (test load #1), midpoint (test load #2), mid-highpoint (test load #3), and highpoint (test load #4), then unload to mid-highpoint (test load #3), midpoint (test load #2), and lowpoint (test load #1)

### 3.6.1.3.5 Calibration Softkeys





The softkeys shown on the Calibration setup screen are used for calibration procedures.

	Capture Zero
	Capture Span
	Step Calibration
	CalFree

#### Capture Zero

The CAPTURE ZERO soft key  triggers an independent operation to reset the zero condition of the scale.





#### To Capture Zero

- 1 Press the CAPTURE ZERO softkey .
  - ➔ The message "Empty scale then press start" displays. The text box shows the raw counts in real time.
- 2 Empty the scale.
- 3 Press the START softkey .
  - ➔ The status of the capture operation displays.
  - ➔ Press the EXIT softkey  to abort the capture process and return the display to the previous screen.
- 4 When the operation is complete, a status message displays that verifies the completion of the capture operation.
  - ➔ If motion is present during the zero capture process, the terminal will process the dynamic weight readings then display a warning message indicating dynamic weight values were used. This message provides choices of No and Yes to either reject or accept the dynamic weight calibration. Move focus to the desired action then press the ENTER key .
- 5 If the capture operation was successful, the message "Capture Zero OK" displays. If the capture operation was not successful, the message "Calibration Failure" displays. If the calibration fails, repeat the capture procedures. If the calibration continues to fail, contact a local METTLER TOLEDO representative for assistance.
- 6 Press the EXIT softkey  to return to the CALIBRATION screen.



#### Capture Span

The CAPTURE SPAN softkey  initiates a sequence to capture span that can be performed independently of capturing zero.

#### To Capture Span

- 1 Press the CAPTURE SPAN softkey .
  - ➔ The SPAN screen displays.
- 2 Enter the weight of Test Load #1 and all other test loads if 3, 4, or 5 point are enabled in Linearity Adjust. Each test load value must be greater than the previously entered test load value. Press the ENTER key .
  - ➔ The message "Place xx kg. Press START." displays. The text box shows the raw counts in real time.
- 3 Place test load # 1 on the scale.
- 4 Press .
  - ➔ The status of the capture operation displays.
  - ➔ Press the EXIT softkey  to abort the calibration process and return the display to the previous screen.
- 5 When the operation is complete, a status message displays that verifies the completion of the capture operation.
- 6 After the first test load calibration is completed, the terminal will either display a message asking to add the next test load (if 3, 4, or 5 point are enabled in Linearity Adjust), or will show a successful or failed calibration result.



- ➔ If motion is present during the zero capture process, the terminal will process the dynamic weight readings then display a warning message indicating dynamic weight values were used. This message provides choices of No and Yes to either reject or accept the dynamic weight calibration. Move focus to the desired action then press the ENTER key .
- 7 Repeat steps 3 - 6 for test load 2, 3, and 4 if enabled by linearity adjustment.
  - 8 If the capture operation was successful, the message "Capture Span OK" displays. If the capture operation was not successful, the message "Calibration Failure" displays. If the calibration fails, repeat the capture procedures. If the calibration continues to fail, contact a local METTLER TOLEDO representative for assistance.
  - 9 Press the EXIT softkey  to return to the CALIBRATION screen.







**For a linearity adjustment method using 3 points, 4 points or 5 points with hysteresis:**

- 1 Refer to the 3-point, 4-point or 5-point linearity adjustment method for the calibration operation. Depending on the linearity adjustment method selected, the process will include removing weight from the scale to achieve better linearity performance.
- 2 Ensure that the scale is unloaded to the test load value always by removing weights. If the scale is unloaded below the test load value, do not add weight to reach the displayed test load value. The process must be restarted from the beginning.

**Step Calibration**

The STEP CALIBRATION softkey  initiates a procedure that enables a "build-up" calibration for tanks and hoppers. For step calibration, the same amount of test weight is added for each step of the calibration procedure.

**To Perform A Step Calibration**

- 1 Press the STEP CALIBRATION softkey .
  - ➔ The STEP CALIBRATION screen displays.
- 2 Enter the weight value of the test weight, then press the ENTER key . Note that the same amount of test weight is used in each step.
  - ➔ The message "Press START" to begin displays.
- 3 Press the START softkey .
  - ➔ The screen shows an active (live) weight display (using the current span factor), the intended target weight entered on the previous screen, and the message "Add test weight" for the next step.
- 4 Add the test weight to the tank/hopper. Each time the test weight is added to the scale, the active display shows the weight.
- 5 When the full amount of test weight has been added, press the OK softkey .
  - ➔ The test weight is captured and span factors are saved. During the time, the message "Add test weight" changes to "Capturing test load", and then to "Remove test weight then fill to target" when the capture is done.
- 6 Remove the test weight. The active display returns to zero.
- 7 Fill the tank/hopper with a substitute material up to near the target weight. It does not have to be the exact target weight.
- 8 Press the OK softkey .
  - ➔ The target weight value recalculates to show the substitute material weight plus the initial intended target weight. The message "Add test weight" displays.
- 9 Add the test weight to the tank/hopper. The active display shows the weight.
- 10 Press the OK softkey .
  - ➔ If the actual weight does not equal the target, a new span factor calculates and the message changes to "Capturing test load". The active weight display changes to match the target weight value. The message changes to "Remove test weight then fill to target".
- 11 Remove the test weight.
  - ➔ The active display returns to the previous weight that displayed for the last test load.
- 12 Repeat steps 7 - 11 until an appropriate number of calibration steps have been completed for the specific application.







13 Press the EXIT softkey  at any step in the procedure to stop the calibration process and return to the STEP CALIBRATION screen.

14 Press the EXIT softkey  to return to the CALIBRATION screen.

## CalFree

The CALFREE softkey  provides access to the CalFree screen for calibration of a scale without test weights.

### To Perform Calibration of Span with CalFree

- 1 Press the CALFREE softkey .  
➔ The CalFree screen displays.
- 2 Enter the load cell capacity, select the appropriate unit, and then press the ENTER key . **Note that the total load cell capacity should be entered here.** For example, for a tank with three 5000 kg cells, cell capacity would be  $3 \times 5000$  kg or 15000 kg.
- 3 Enter the rated load cell output value, then press the ENTER key . **Note that if multiple load cells are used, the average output of all cells should be entered here.** The average output is determined by adding the output values of all cells together and dividing the sum by the number of cells.
- 4 In the Use Zero selection list, choose Calibrated or Estimated. If Estimated is selected, proceed at step 5. Otherwise, continue at step 6.
- 5 If Estimated is selected in Use Zero, enter an estimated preload value in the Estimated Preload text field, then press the ENTER key .
- 6 Press the OK softkey .  
➔ The span is calculated using the parameters entered.
- 7 If the capture operation was successful, the message "Calibration OK" displays. If the calibration operation was not successful, the message "Calibration Failure" displays. If the calibration fails, repeat the capture procedures. If the calibration continues to fail, contact a local METTLER TOLEDO representative for assistance.
- 8 Press the EXIT key  to return to the CALIBRATION screen.

### 3.6.1.4 Zero

This section provides access to Auto Zero Maintenance (AZM) settings, under zero blanking, power-up zero, and pushbutton zero parameters.

#### 3.6.1.4.1 AZM & Display

AZM (Automatic Zero Maintenance) is a means of tracking zero when the scale is empty. AZM compensates for conditions such as terminal or load cell drift or slow debris buildup on a scale platform.

##### Auto Zero

Use the Auto Zero parameter to select the auto zero maintenance parameter.

Available option (s):

Disable, **Gross** [default], Gross and Net

##### Auto Zero Range

Set the auto zero range for the number of divisions (d) around the current zero setting in which auto zero will operate.

Default: **0.5 d**, OIML Default: **0.5 d**

##### Under Zero Blanking

Blanking of the display (\_\_\_\_\_) is used to indicate an under-zero condition when the weight on the scale falls below the current zero reference. Set the under zero blanking for the number of divisions (d) that the terminal is permitted to go under zero before blanking.

Default: **5 d**, OIML Default: **20 d**

**Note: A value of 99 disables blanking under zero and the terminal will display a weight as far under zero as possible.**

### Power Up

Power Up determines if at power up, the terminal will restart with the most recent zero reference point it had before power down or if it will reset to the calibrated zero reference. If Restart is selected, the terminal reuses the most recent zero reference weight after a power cycle so it returns to the same, previously displayed gross weight value. If Reset is selected, the last zero calibration value is used as the zero reference point.

Available option (s):

Reset, **Restart** [default], OIML default: Reset

**Note:** When OIML default values are used (refer to [Approval ▶ Page 64]), Restart must be selected if Power Up Zero (refer to [Power Up Zero ▶ Page 71] ) is disabled, or Reset must be selected if Power Up Zero is enabled.

### Timed Zero

When enabled, the Timed Zero function monitors the weighing system to ensure that the system sees the center of zero condition at stability within a certain pre-determined time or the scale is disabled.

It is strongly recommended to leave Timed Zero disabled (default condition) unless the application/installation requires MID R51 approval for automatic catchweighing equipment.

Available option (s):

**Disabled** [default], 10 minutes, 15 minutes, 30 minutes

#### 3.6.1.4.2 Ranges

Use the settings on the Ranges screen to enable or disable Power Up Zero capture and Pushbutton Zero and to set the ranges around the original zero condition for the scale for applying these functions.

### Power Up Zero

If Power Up Zero is enabled, the terminal tries to capture zero upon power up and a range within which zero will be captured is shown and is programmable. If Power Up Zero is disabled, the initial zero reference at power up will revert to the most recent zero reference point or to calibrated zero based on the Power Up selection on the AZM & Display screen.

Available option (s):

**Disabled** [default], Enabled, OIML default: Enabled

### Power Up Zero Range

If Power Up Zero is enabled, **+Range** and **-Range** fields display for setting the range around the original calibrated zero of the scale within which Power Up Zero can be applied. The range units are percent.

Value range:

+Range: +0% - +99%, default: **+0%**, OIML default: **+18%**

-Range: -0% - -99%, default: **-0%**, OIML default: **-2%**

For example, if the +Range setting for Power Up Zero is set at 2%, Power Up Zero will only occur when the weight reading on the scale is less than 2% of scale capacity above the original calibrated zero reference. If the -Range setting for pushbutton zero is set at 2%, Power Up Zero will only occur when the weight reading on the scale is less than 2% of scale capacity below the original calibrated zero reference.

**Note: If Power Up Zero capture is enabled and the weight on the scale is outside of the zero capture range, the display indicates "EEE" until the weight is adjusted to be within this range and zero is captured.**

### Pushbutton Zero

If Pushbutton Zero is enabled, the ZERO scale function key  will operate to capture new zero reference points.

If Pushbutton Zero is disabled, execution of a remote zero is still possible via SICS, CPTZ, SMA commands from a PC, a discrete input or from PLC commands. To set the zero range for these remote zero functions, first enable the Pushbutton Zero, select the pushbutton zero range and then disable the Pushbutton Zero.

Available option (s):

Disabled, **Enabled** [default]

### Pushbutton Zero Range

If Pushbutton Zero is enabled, **+Range** and **-Range** fields display for setting the range around the original calibrated zero of the scale within which Pushbutton Zero can be applied. The range units are percent.

Value range:

+Range: +0% - +99%, default: **+2%**

-Range: -0% - -99%, default: **-2%**

For example, if the +Range setting for Pushbutton Zero is set at 2%, Pushbutton Zero can only be used when the weight reading on the scale is less than 2% above the original calibrated zero reference. If the -Range setting for Pushbutton Zero is set at 2%, the Pushbutton Zero can only be used when the weight reading on the scale is less than 2% below the original calibrated zero reference.

## 3.6.1.5 Tare

Tare is used to subtract the weight of an empty container from the gross weight on the scale to determine the net weight of the contents. Tare is prohibited if the scale is in motion. This branch provides access to program the tare types, auto tare and auto clear tare parameters.

### 3.6.1.5.1 Tare Types

Use the Tare Type screen to enable or disable pushbutton tare, keyboard tare, and net sign correction.

#### Pushbutton Tare

When pushbutton tare is enabled, the TARE scale function key  on the front panel can be pressed when an empty container is on the scale, in order to determine tare. The terminal displays a zero weight and net mode. When the container is loaded and placed back on the scale, the terminal displays the net weight of the contents. If pushbutton tare is disabled, execution of a remote tare is still possible via SICS, CPTZ, and SMA commands from a PC, a discrete input, or using PLC commands.

Available option (s):

Disabled, **Enabled** [default]

#### Keyboard Tare

When keyboard tare, or preset tare, is enabled, the known value for the empty weight of a container (tare) can be entered manually. The terminal will then display the net weight of the contents of the container. Keyboard tares are automatically rounded to the closest display division.

Available option (s):

Disabled, **Enabled** [default]

#### Net Sign Correction

Net sign correction enables the terminal to be used for both shipping (inbound empty) and receiving (inbound loaded) operations. If net sign correction is enabled, the terminal will switch the gross and tare weight fields on the printed ticket, if necessary, so that the larger weight is the gross weight, the smaller weight is the tare weight, and the difference is always a positive net weight. Net sign correction affects the printed data output, the recalled weight display and the displayed weight. Continuous data output will continue to show a negative net weight value.

Available option (s):

**Disabled** [default], Enabled

Net sign correction will operate with pushbutton tare, preset tare, or tare records stored in the Tare Table. An example of weight values with and without net sign correction is shown in the table below. In this example, the tare register value is 53 kg and the live weight on the scale is 16 kg.

### Weight Values with and Without Net Sign Correction

Printed and Displayed	Net Sign Correction	
	Disabled	Enabled
Gross	16 kg	53 kg
Tare	53 kg	16 kg
Net	-37 kg	37 kg

Note: When net sign correction is enabled, the tare weight field in the recall display will be labeled with the letter "M" to indicate "Memory" instead of "T" or "PT".

#### 3.6.1.5.2 Auto Tare

Use the Auto Tare screen to enable or disable automatic tare and to set the tare and reset threshold weights, and enable or disable motion check.

##### Auto Tare

When Auto Tare is enabled, the tare weight is taken automatically when a container above the threshold weight is on the scale and settles to no-motion.

Available option (s):

**Disabled** [default], Enabled

##### Tare Threshold Weight

This parameter appears when Auto Tare is set to Enabled. When weight on the scale platform exceeds the programmed tare threshold value and settles to no motion, the terminal automatically tares.

##### Reset Threshold Weight

This parameter appears when Auto Tare is set to Enabled. The reset threshold weight must be less than the tare threshold weight. When the weight on the scale platform falls below the reset threshold value, such as when a load has been removed, the terminal automatically resets the auto tare trigger, depending upon the programming of motion checking.

##### Motion Check

This parameter appears when Auto Tare is set to Enable. When Motion Check is set to Enabled, the scale must detect a non-motion condition below the reset value to reset the auto tare trigger.

Available option (s):

Disabled, **Enabled** [default]

#### 3.6.1.5.3 Auto Clear

Use the Auto Clear screen to program Auto Clear Tare, Clear After Print, to set the Clear Threshold Weight, and enable or disable Motion Check for auto clearing of tare.

##### Auto Clear Tare

To clear tare automatically when the scale returns to below the threshold weight, set the Auto Clear Tare to Enabled.

Available option (s):

**Disabled** [default], Enabled

##### Clear Threshold Weight

This parameter appears when Auto Clear Tare is set to Enabled. When the gross scale weight exceeds then falls below the programmed Clear Threshold Weight value, the terminal automatically clears tare and returns to gross mode.

### **Motion Check**

This parameter appears when Auto Clear is set to Enabled. To prevent auto clear from occurring when the scale is in motion, set the Motion Check to Enabled.

Available option (s):

Disabled, **Enabled** [default]

### **Clear After Print**

To clear tare automatically after printing, set Clear After Print to Enabled.

Available option (s):

**Disabled** [default], Enabled

### **Clear With Zero**

To clear tare automatically when capturing zero from the net mode, set the Clear With Zero to Enabled.

Available option (s):

**Disabled** [default], Enabled

### **Power Up**

A Power Up setting of Restart enables the terminal to reuse the last tare weight after a power cycle. If Reset is selected, the terminal returns to gross mode upon power up and the last tare weight after the power cycle is cleared.

Available option (s):

**Restart** [default], Reset

## **3.6.1.6 Units**

The Units screen enables the selection of a second and a third unit and determines which unit is used at power up. If printing of two units is required, establish Third Units. Both Primary and Third units can be printed simultaneously in an output template.

### **3.6.1.6.1 Second Unit**

Use the Second Unit selection box to select a second weighing unit. Only one custom unit is possible.

Available option (s):

**None** [default], Custom, grams (g), kilograms (kg), pounds (lb), ounces (oz), tonnes (t), tons (ton)

### **3.6.1.6.2 Third Unit**

Use the Third Unit selection box to select a third weighing unit.

Available option (s):

**None** [default], Custom, grams (g), kilograms (kg), pounds (lb), ounces (oz), tonnes (t), tons (ton)

### **3.6.1.6.3 Power Up**

This parameter defines the units the terminal defaults to after power up.

Available option (s):

Primary Units	The terminal restarts in primary units.
<b>Restart</b> [default]	The terminal restarts with whichever units were last displayed before the power cycle.

### **3.6.1.6.4 Custom Factor**

This parameter only appears if a Custom unit is selected. Enter a multiplication factor for the custom unit in this field, such as 0.592 or 1.019. The primary unit is multiplied by the custom factor to obtain the custom value.

### 3.6.1.6.5 Custom Name

This parameter only appears if a Custom unit is selected. Use the alpha keys to enter the name for the custom unit. Up to 12 characters may be entered. The terminal displays the first five letters of the custom name in the units area of the display when custom units are in use.

### 3.6.1.6.6 Custom Increment

This parameter only appears if a Custom unit is selected. Enter a custom increment in this field, such as 0.1 or 0.5. This step controls both the decimal position and the increment size of the custom unit value.

### 3.6.1.7 Rate

A Rate, expressed as change in primary or secondary weight units per time unit, may be programmed for display on the terminal and/or used in controlling discrete outputs – for example as the source for a Comparator ( refer to Configuration and Operation for more details).

Note: the Rate display is selectable for display in the auxiliary display area below the weight display. Refer to [Auxiliary Display ▶ Page 111] for more information on using the auxiliary display.

If the weight information in the terminal becomes invalid, the Rate display will show 0.000.

### 3.6.1.7.1 Weight Units

Weight Units define which weight unit will be used for the rate calculation.

Available option (s):

<b>None</b> [default]	Rate function is disabled.
Primary	Primary weight units are used.
Secondary	Secondary weight units are used. A secondary unit must be enabled for this choice to be shown.

### 3.6.1.7.2 Time Units

Time Units determine what time reference will be used for the rate value.

Available option (s):

**Seconds** [default], Minutes, Hours

### 3.6.1.7.3 Measurement Period

The Measurement Period value sets the frequency of weight measurements.

Available option (s):

0.5 seconds, **1 second** [default], 5 seconds

### 3.6.1.7.4 Output Average

Output from the rate function is set by a computed rolling average of measurements. The Output Average value should be sufficiently larger than the Measurement Period to allow the terminal to take multiple measurements for each average.

Value range:

1 - 99 seconds. Default: **5 seconds**

### 3.6.1.8 Filter

The analog version terminal has a low-pass, multi-pole vibration filter that can be set for several conditions when using analog load cells. The heavier the filtering, the slower the display settling time will be.

### 3.6.1.8.1 Low Pass Frequency

Low Pass Frequency is the frequency above which all disturbances are filtered out. The lower the frequency, the better the disturbance rejection, but the longer the settling time required for the scale.

Note that values below 1.0 should not be used due to the extremely long settling time.

Value range:

0.2 - 9.9 Hz. Default: **2.0 Hz**

### 3.6.1.8.2 Low Pass # of Poles

The number of poles determines the slope of the filtering cutoff. For most applications, a slope value of 8 is acceptable; however, decreasing this number will improve settling time slightly. Choices are:

Available option (s):

2, 4, 6, **8** [default]

### 3.6.1.8.3 Notch Filter Frequency

The Notch Filter Frequency allows selection of one specific frequency above the low pass filter value that can also be filtered out. This enables setting the low pass filter lower to filter out all but one frequency (that the notch filter will handle) and obtain a faster settling time.

Value range:

0 (Disabled) - 99 Hz. Default: **30 Hz**

**Note: Entering a value of 0 in the entry box will disable this functions.**

### 3.6.1.8.4 Stability Filter

The Stability Filter works in conjunction with the Low Pass Frequency to provide a more stable final weight reading.

Available option (s):

**Disabled** [default], Enabled

**Note: the Stability Filter should only be used in transaction weighing applications, since the nonlinear action of the filter switching may cause inaccurate cutoffs in batching or filling applications.**

## 3.6.1.9 Stability

The terminal includes a stability detector (weight in motion). The Stability setup screen enables setting a Motion Range, No-Motion Interval and Timeout period.

### 3.6.1.9.1 Motion Range

Sets the Motion Range to the weight value (in divisions) that the weight is permitted to fluctuate and still have a no-motion condition.

Value range:

0.1 - 99.9 d. Default: **1.0 d**

### 3.6.1.9.2 No-Motion Interval

The No-Motion Interval defines the amount of time (in seconds) that the scale weight must be within the motion range to have a no-motion condition. A shorter interval means that a no-motion condition is more likely, but may make weight measurement less precise.

Value range:

0.0 (motion detection disabled) - 2.0 seconds. Default: **0.3 seconds**

**Note: Entering a value of 0 will disable the motion detection function.**

### 3.6.1.9.3 Timeout

The Timeout defines the period (in seconds) after which the terminal stops attempting to perform a function that requires a no-motion condition (such as a zero, tare or print command) and aborts the function. This timeout is used regardless of the source of the command such as the keypad, discrete input, PLC or SICS. A smaller value means that less time will be used to check for no-motion before aborting a command. When a value of 0 is entered, there must be no-motion when a command is given or it will fail immediately. A value of 99 is a special condition which permits the terminal to wait indefinitely for a no-motion condition - a command would never be aborted.



Value range:

0 - 99 seconds. Default: **3 seconds**

### 3.6.1.10 Log or Print

The Log or Print setup branch is where the thresholds to control how and when a demand data output is triggered. Normal demand mode printing occurs whenever a print request is made, providing there is no motion on the scale and the weight is above gross zero (a negative gross weight will not be printed).

The weight values entered are the gross weight values in primary units. Gross weight in primary units is used regardless of whether the terminal is in Gross or Net mode and regardless of the units that are displayed.

#### 3.6.1.10.1 Minimum Weight

The minimum weight setting is the threshold below which log or print functions will not initiate. Primary units are displayed for this field. Enter the required value in primary weight units.

#### 3.6.1.10.2 Interlock

Interlock prevents repeat logging and printing. When enabled, this interlock requires that the live weight reading be reset according to the Reset On parameter setting (see below). The live weight must then settle to a weight greater than the Minimum Weight value (see above) before responding to the next log or print request.

Available option (s):

**Disabled** [default], Enabled

#### 3.6.1.10.3 Automatic

This parameter triggers an automatic log and print request every time the weight on the scale settles to a positive value that is larger than the entered Threshold Weight value (see below). After the initial log or print, the automatic trigger must reset per the Reset On parameter setting (see below) before the next automatic log and print can occur. This parameter includes the following selections. Note that if Automatic is set to Disabled, the Threshold Weight field does not appear.

Available option (s):

**Disabled** [default], Enabled

#### 3.6.1.10.4 Reset On

The reset of Interlock and Automatic printing or logging can be based on weight threshold or weight deviation values. Select the desired operating mode and enter the weight value in the Reset On field. If both Interlock and Automatic settings are disabled, the Reset On field does not display. If Reset On is set to Deviation, the Threshold Weight and Motion Check fields do not display.

Available option (s):

Deviation                      The weight must change more than this absolute value for the Interlock and Automatic print to reset.

**Return** [default]              The weight must return to below this value for the Interlock and Automatic print to reset.

#### 3.6.1.10.5 Threshold Weight

The Threshold Weight is the value above which an Automatic logging or printing of data can/will be triggered. Threshold Weight does not appear if Automatic is set to Disabled or if Reset On is set to Deviation.

#### 3.6.1.10.6 Motion Check

Enable the motion check setting to prevent interlock and automatic log and print functions from resetting when the scale is in motion below the Reset On return point. Motion Check does not appear if Reset ON is set to Deviation. Choices are:

Available option (s):

**Disabled** [default], Enabled

### 3.6.1.11 MinWeigh

When the MinWeigh function is enabled, the current net weight is compared with MinWeigh Threshold to determine whether the weighing equipment selected for a particular measurement is adequate for the task.

#### 3.6.1.11.1 MinWeigh

1 To configure MinWeigh, follow the path Setup>Scale>MinWeigh or press the MINWEIGH softkey  in the Home Page.

Security level of the MINWEIGH softkey: Admin: Read / Write, Supervisor: Read / Write, Operator: Read

2 Refer to the table below to do the configuration.



Figure 56: MinWeigh Configure

3 When a configuration item is in focus, press the INFORMATION softkey  to trigger a Popup Message Box to indicate some instruction about the focused configuration item.

Configuration Item	Parameter Description	Security	Comments
Minimum Weight Determined(MWdet)	<ul style="list-style-type: none"> <li>Weight for which the measurement uncertainty is equal to the process tolerance at the time of calibration</li> <li>MinWeigh operation can be disabled or enabled.</li> </ul>	<ul style="list-style-type: none"> <li>Admin: Read/Write</li> <li>Supervisor: Read/Write</li> <li>Operator: Read</li> </ul>	If this field is blank or filled with 0, MinWeigh is disabled. Even if MinWeigh is disabled, other following setting can still be visible and editable.
Safety Factor	<ul style="list-style-type: none"> <li>The safety factor in use to account for environmental influences on the weighing process over time</li> <li>1 ≤ Value ≤ 10, 1 [default]</li> </ul>	<ul style="list-style-type: none"> <li>Admin: Read/Write</li> <li>Supervisor: Read/Write</li> <li>Operator: Read</li> </ul>	-
Process Tolerance	<ul style="list-style-type: none"> <li>The relative weighing process tolerance applied to determine the Minimum Weight.</li> <li>0 [default], 1 to 100</li> </ul>	<ul style="list-style-type: none"> <li>Admin: Read/Write</li> <li>Supervisor: Read/Write</li> <li>Operator: Read</li> </ul>	Entered as a percentage
Minimum Weight Safety Factor (MWsf)	MWdet x Safety Factor	<ul style="list-style-type: none"> <li>Admin: Read</li> <li>Supervisor: Read</li> <li>Operator: Read</li> </ul>	The Value of MWdet * Safety Factor

### 3.6.1.11.2 MinWeigh Behavior

When MinWeigh is enabled, the MinWeigh Behavior page is used to configure the behavior in case of MinWeigh violation – Net Weight < MinWeigh.

1 To configure MinWeigh Behavior, follow the path Setup>Scale>MinWeigh>MinWeigh Behavior.

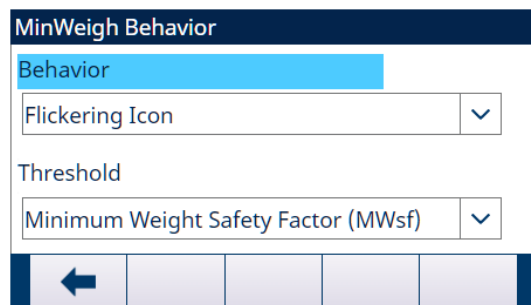

Figure 57: MinWeigh Behavior

2 Refer to the table below to do the configuration.

Configuration Items	Options	Security
Behavior	<ul style="list-style-type: none"> <li>Flickering Icon</li> <li>Flickering Icon and Grey Weight [default]</li> <li>Flickering Icon and No Weight</li> </ul>	<ul style="list-style-type: none"> <li>Admin: Read/Write</li> <li>Supervisor: Read/Write</li> <li>Operator: Read</li> </ul>
Threshold	<ul style="list-style-type: none"> <li>Minimum Weight Determined(MWdef)</li> <li>Minimum Weight Safety Factor (MWsf) [default]</li> </ul>	<ul style="list-style-type: none"> <li>Admin: Read/Write</li> <li>Supervisor: Read/Write</li> <li>Operator: Read</li> </ul>

#### Display

MinWeigh Disabled

No MinWeigh Icon is displayed, the weight displays as normal.



- MinWeigh Enabled
- Net weight < MinWeigh Threshold
  - MinWeigh Behavior: Flickering Icon



- Net weight < MinWeigh Threshold
- MinWeigh Behavior: Flickering Icon and Grey Weight

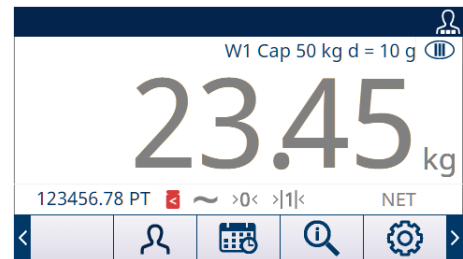

- Net weight < MinWeigh Threshold
- MinWeigh Behavior: Flickering Icon and No Weight



Net weight  $\geq$  MinWeigh Threshold

The MinWeigh icon  shows but does not flicker.





### 3.6.1.12 Reset

The Reset screen enables Scale branch setup values to be reset to factory default settings.

Note: Scale Reset does NOT include the reset of metrologically significant parameters – scale type, approval, weight units, capacity, increment, or calibration data. This data is reset only by performing a Master Reset with switch SW2-1 in its ON position, or a Reset function in the IDNet or SICSpro load cell.

#### 3.6.1.12.1 Initiate Reset

- 1 Press the OK softkey  on the SCALE RESET screen to initiate scale reset, or press the EXIT softkey  to exit without resetting.
- 2 If the reset was successful, the message "Reset Successful" displays. If the reset was not successful, the message "Reset Failure" displays. If the reset fails, try to initiate the reset again. If the reset continues to fail, contact a local METTLER TOLEDO representative for assistance.

## 3.6.2 Scale - IDNet

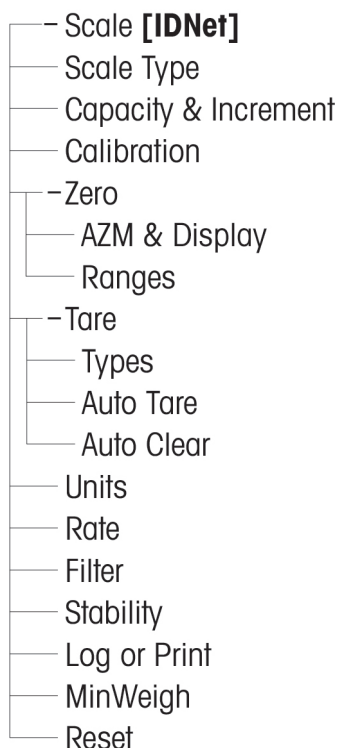



Figure 58: Setup Menu of Scale - IDNet

Metrological and some environmental parameters are accessed and stored in the load cell for the IDNet interface. So the Scale branch has a reduced set of parameters. Access to the setup in the IDNet load cell is called the Service Mode and is accessible from a softkey  on the Calibration screen.

### 3.6.2.1 Scale Type

The Scale Type screen permits a name to be assigned to the scale, displays the scale PCB type in the terminal, provides a selection list for the Approval mode, and allows entry of the approval class and interval for the metrology line.

#### 3.6.2.1.1 Name

The Name field enables entry of the scale identification. Enter the scale name (an alpha-numeric string of up to 20 characters) in the Name entry box.

Default: **Scale 1**

#### 3.6.2.1.2 Scale Type

The Scale Type field indicates which type of scale this terminal supports.

Available option (s):

**IDNet** [default for IDNet version]

#### 3.6.2.1.3 Class

Class is shown if the base has been programmed as Approved. This is a display-only value as programmed in the scale.

Available option (s):

II, III, III HD, III L, IIII

#### 3.6.2.1.4 Verified Interval

Verified Interval shows only when the scale is approved and Class has been selected as II.

The Verified Interval indicates if the approved increment size is equal to the displayed increment size or if it is 10 times the displayed increment size. This information is included in the data shown in the metrological line at the top of the display.

Available option (s):

e=d, e=10d

### 3.6.2.2 Capacity & Increment

Use the Capacity and Increment setup screen to view primary units and expand x10 mode.

#### 3.6.2.2.1 Primary Units

View the primary units as programmed in the base. This is a display-only value.

Available option (s):

grams (g), **kilograms (kg)** [default], pounds (lb)

#### 3.6.2.2.2 x10 Always

X10 Always locks the IDNet base into a higher resolution weight display. If the X10 Always mode is enabled, the high resolution weight data from the IDNet base displays at all times and the EXPAND BY 10 softkey  (if configured to display) is inactivated. The weight unit displayed is the weight unit that the IDNet scale base was calibrated in (the Primary Unit) and cannot be switched to another weight unit.

Available option (s):

**Disabled** [default], Enabled



### NOTICE

**Note that for IDNet platforms in the approved mode, in order for the x10 function to operate properly, the Update Rate must be set at 20. Values of 5 or 10 for the update rate will result in longer display of the expanded weight value, which is not permitted.**



### 3.6.2.3 Calibration

The Calibration screens enable entry of the base serial number and provide access to the Service Mode of an IDNet scale.

#### 3.6.2.3.1 Base Serial Number

If appropriate, enter the connected scale base serial number in this field. An entry of up to 14 characters is possible.

#### 3.6.2.3.2 Service Mode

This screen displays a single box that shows messages from the IDNet base up to 16 characters. When either the OK softkey  or the CANCEL softkey  is pressed, the terminal sends the respective response to the scale base and the next message to be displayed is transmitted back to the terminal from the base. This sequence remains constant during the complete service mode communication sequence.

After the last communication from the scale base has been completed, the display returns to the Calibration screen.

### 3.6.2.4 Zero

This section provides access to Auto Zero Maintenance (AZM) settings, power-up zero, and timed zero parameters.

#### 3.6.2.4.1 AZM & Display

AZM (Automatic Zero Maintenance) is a means of tracking zero when the scale is empty. AZM compensates for conditions such as terminal or load cell drift or slow debris buildup on a scale platform.

## Auto Zero

Use the Auto Zero parameter to select the auto zero maintenance parameter.

Available option (s):

Disabled, **Enabled** [default]

## Power Up

Power Up determines if at power up, the terminal will restart with the most recent zero reference point it had before power down or if it will reset to the calibrated zero reference. If Restart is selected, the terminal reuses the most recent zero reference weight after a power cycle so it returns to the same, previously displayed gross weight value. If Reset is selected, the last zero calibration value is be used as the zero reference point.

Available option (s):

Reset, **Restart** [default], OIML default: Reset

## Timed Zero

When enabled, the Timed Zero function monitors the weighing system to ensure that the system sees the center of zero condition at stability within a certain pre-determined time or the scale is disabled.

It is strongly recommended to leave Timed Zero disabled (default condition) unless the application/installation requires MID R51 approval for automatic catchweighing equipment.

Available option (s):

**Disabled** [default], 10 minutes, 15 minutes, 30 minutes

### 3.6.2.4.2 Ranges

Use the settings on the Zero Ranges screen to enable or disable the Pushbutton Zero function.

#### Pushbutton Zero

If Pushbutton Zero is enabled, the ZERO scale function key  will operate to capture new zero reference points.

If Pushbutton Zero is disabled, execution of a remote zero is still possible via SICS, CPTZ, SMA commands from a PC, a discrete input or from PLC commands. To set the zero range for these remote zero functions, first enable the Pushbutton Zero, select the pushbutton zero range and then disable the Pushbutton Zero.

Disabled, **Enabled** [default]

### 3.6.2.5 Tare

Tare is used to subtract the weight of an empty container from the gross weight on the scale to determine the net weight of the contents. Tare is prohibited if the scale is in motion. This branch provides access to program the tare types, auto tare and auto clear tare parameters.

#### 3.6.2.5.1 Tare Types

Use the Tare Type screen to enable or disable pushbutton tare, keyboard tare, and net sign correction.

##### Pushbutton Tare

When pushbutton tare is enabled, the TARE scale function key  on the front panel can be pressed when an empty container is on the scale, in order to determine tare. The terminal displays a zero weight and net mode.

When the container is loaded and placed back on the scale, the terminal displays the net weight of the contents. If pushbutton tare is disabled, execution of a remote tare is still possible via SICS, CPTZ, and SMA commands from a PC, a discrete input, or using PLC commands.

Available option (s):

Disabled, **Enabled** [default]

##### Keyboard Tare

When keyboard tare, or preset tare, is enabled, the known value for the empty weight of a container (tare) can be entered manually. The terminal will then display the net weight of the contents of the container. Keyboard tares are automatically rounded to the closest display division.

Available option (s):

Disabled, **Enabled** [default]

### Net Sign Correction

Net sign correction enables the terminal to be used for both shipping (inbound empty) and receiving (inbound loaded) operations. If net sign correction is enabled, the terminal will switch the gross and tare weight fields on the printed ticket, if necessary, so that the larger weight is the gross weight, the smaller weight is the tare weight, and the difference is always a positive net weight. Net sign correction affects the printed data output, the recalled weight display and the displayed weight. Continuous data output will continue to show a negative net weight value.

Available option (s):

**Disabled** [default], Enabled

Net sign correction will operate with pushbutton tare, preset tare, or tare records stored in the Tare Table. An example of weight values with and without net sign correction is shown in the table below. In this example, the tare register value is 53 kg and the live weight on the scale is 16 kg.

### Weight Values with and Without Net Sign Correction

Printed and Displayed	Net Sign Correction	
	Disabled	Enabled
Gross	16 kg	53 kg
Tare	53 kg	16 kg
Net	-37 kg	37 kg

Note: When net sign correction is enabled, the tare weight field in the recall display will be labeled with the letter "M" to indicate "Memory" instead of "T" or "PT".

### Terminal Tare

When Terminal Tare is disabled, all Tare commands received by the terminal via SICS, CTPZ, PLC or keypad will be passed through to the IDNet base for execution. The base will calculate the tare and net weight values and pass this information back to the terminal. When Terminal Tare is enabled, tare and net weight values are calculated in the terminal and not in the high precision IDNet base.

Available option (s):

**Disabled** [default], Enabled

When Terminal Tare is enabled, the stability timeout value will be set to 3 seconds (default), but can be set to any value between 0 and 99 in the setup menu at **Scale > Stability**. A value of 99 instructs the terminal to wait indefinitely for a stable condition – a tare command would never be aborted due to motion.

When Terminal Tare is disabled, the stability timeout value defaults to 99, and cannot be modified. The terminal will not display or transmit net status, net weight or tare weight until it receives this information from the scale base. Only when the IDNet base responds will the terminal display and transmit the tare value and net status to the PC/PLC.



#### NOTICE

**Terminal Tare should be disabled for approved (legal-for-trade) systems.**



#### NOTICE

**When Terminal Tare is disabled, the stability timeout value defaults to 99, and cannot be modified.**



### 3.6.2.5.2 Auto Tare

Use the Auto Tare screen to enable or disable automatic tare and to set the tare and reset threshold weights, and enable or disable motion check.

#### Auto Tare

When Auto Tare is enabled, the tare weight is taken automatically when a container above the threshold weight is on the scale and settles to no-motion.

Available option (s):

**Disabled** [default], Enabled

#### Tare Threshold Weight

This parameter appears when Auto Tare is set to Enabled. When weight on the scale platform exceeds the programmed tare threshold value and settles to no motion, the terminal automatically tares.

#### Reset Threshold Weight

This parameter appears when Auto Tare is set to Enabled. The reset threshold weight must be less than the tare threshold weight. When the weight on the scale platform falls below the reset threshold value, such as when a load has been removed, the terminal automatically resets the auto tare trigger, depending upon the programming of motion checking.

#### Motion Check

This parameter appears when Auto Tare is set to Enable. When Motion Check is set to Enabled, the scale must detect a non-motion condition below the reset value to reset the auto tare trigger.

Available option (s):

Disabled, **Enabled** [default]

### 3.6.2.5.3 Auto Clear

Use the Auto Clear screen to program Auto Clear Tare, Clear After Print, to set the Clear Threshold Weight, and enable or disable Motion Check for auto clearing of tare.

#### Auto Clear Tare

To clear tare automatically when the scale returns to below the threshold weight, set the Auto Clear Tare to Enabled.

Available option (s):

**Disabled** [default], Enabled

#### Clear Threshold Weight

This parameter appears when Auto Clear Tare is set to Enabled. When the gross scale weight exceeds then falls below the programmed Clear Threshold Weight value, the terminal automatically clears tare and returns to gross mode.

#### Motion Check

This parameter appears when Auto Clear is set to Enabled. To prevent auto clear from occurring when the scale is in motion, set the Motion Check to Enabled.

Available option (s):

Disabled, **Enabled** [default]

#### Clear After Print

To clear tare automatically after printing, set Clear After Print to Enabled.

Available option (s):

**Disabled** [default], Enabled

### Clear With Zero

To clear tare automatically when capturing zero from the net mode, set the Clear With Zero to Enabled.

Available option (s):

**Disabled** [default], Enabled

### Power Up

A Power Up setting of Restart enables the terminal to reuse the last tare weight after a power cycle. If Reset is selected, the terminal returns to gross mode upon power up and the last tare weight after the power cycle is cleared.

Available option (s):

**Restart** [default], Reset

### 3.6.2.6 Units

The Units screen enables the selection of a second and a third unit and determines which unit is used at power up. If printing of two units is required, establish Third Units. Both Primary and Third units can be printed simultaneously in an output template.

#### 3.6.2.6.1 Second Unit

Use the Second Unit selection box to select a second weighing unit. Only one custom unit is possible.

Available option (s):

**None** [default], Custom, grams (g), kilograms (kg), pounds (lb), ounces (oz), tonnes (t), tons (ton)

#### 3.6.2.6.2 Third Unit

Use the Third Unit selection box to select a third weighing unit.

Available option (s):

**None** [default], Custom, grams (g), kilograms (kg), pounds (lb), ounces (oz), tonnes (t), tons (ton)

#### 3.6.2.6.3 Power Up

This parameter defines the units the terminal defaults to after power up.

Available option (s):

Primary Units	The terminal restarts in primary units.
<b>Restart</b> [default]	The terminal restarts with whichever units were last displayed before the power cycle.

#### 3.6.2.6.4 Custom Factor

This parameter only appears if a Custom unit is selected. Enter a multiplication factor for the custom unit in this field, such as 0.592 or 1.019. The primary unit is multiplied by the custom factor to obtain the custom value.

#### 3.6.2.6.5 Custom Name

This parameter only appears if a Custom unit is selected. Use the alpha keys to enter the name for the custom unit. Up to 12 characters may be entered. The terminal displays the first five letters of the custom name in the units area of the display when custom units are in use.

#### 3.6.2.6.6 Custom Increment

This parameter only appears if a Custom unit is selected. Enter a custom increment in this field, such as 0.1 or 0.5. This step controls both the decimal position and the increment size of the custom unit value.

#### 3.6.2.7 Rate

A Rate, expressed as change in primary or secondary weight units per time unit, may be programmed for display on the terminal and/or used in controlling discrete outputs – for example as the source for a Comparator ( refer to Configuration and Operation for more details).

Note: the Rate display is selectable for display in the auxiliary display area below the weight display. Refer to [Auxiliary Display ► Page 111] for more information on using the auxiliary display.

If the weight information in the terminal becomes invalid, the Rate display will show 0.000.

### 3.6.2.7.1 Weight Units

Weight Units define which weight unit will be used for the rate calculation.

Available option (s):

<b>None</b> [default]	Rate function is disabled.
Primary	Primary weight units are used.
Secondary	Secondary weight units are used. A secondary unit must be enabled for this choice to be shown.

### 3.6.2.7.2 Time Units

Time Units determine what time reference will be used for the rate value.

Available option (s):

**Seconds** [default], Minutes, Hours

### 3.6.2.7.3 Measurement Period

The Measurement Period value sets the frequency of weight measurements.

Available option (s):

0.5 seconds, **1 second** [default], 5 seconds

### 3.6.2.7.4 Output Average

Output from the rate function is set by a computed rolling average of measurements. The Output Average value should be sufficiently larger than the Measurement Period to allow the terminal to take multiple measurements for each average.

Available option (s):

1 - 99 seconds. Default: **5 seconds**

## 3.6.2.8 Filter

The IDNet version terminal provides choices for vibration and the type of weighing process.

### 3.6.2.8.1 Vibration

Use the Vibration selection box to select a condition setting that reflects the platform's specific location's conditions. This setting is then sent to the load cell and stored there.

Available option (s):

Ideal Conditions	The weighing platform operates very quickly. However, it is very sensitive. This setting is suitable for a very calm and stable weighing location.
<b>Average Conditions</b> [default]	This is the factory default setting and is suitable for most normal environments.
Extreme Conditions	The base reacts to changes in weight more slowly but is much more stable in unstable environments.

### 3.6.2.8.2 Weighing Process

Use the Weighing Process selection box to select the specific weighing process in use on the platform. This setting is then sent to the load cell and stored there.

Available option (s):

Fine Filling	Used when liquid or fine powders are being weighed
<b>Universal Weighing</b> [default]	For solid materials coarse filling or checkweighing

Static Weighing	For solid materials and weighing under extreme conditions such as strong vibrations
Dynamic Weighing	For weighing products that will not be fully stable or still during the weighing process

### 3.6.2.8.3 Update Rate

This parameter originally shows the update rate of scale weighing information and can be edited by users.



#### NOTICE

**Note that for IDNet platforms in the approved mode, in order for the x10 function to operate properly, the Update Rate must be set at 20. Values of 5 or 10 for the update rate will result in longer display of the expanded weight value, which is not permitted.**

### 3.6.2.9 Stability

For IDNet bases, a stability measure and timeout period may be set.

#### 3.6.2.9.1 Stability

Stability settings for IDNet load cells are configured by selecting a number setting of 0 (disabled), 1 (fast display, good repeatability), 2 (slower display, better repeatability), 3 (slower display, better repeatability), or 4 (very slow display, very good repeatability) in the Stability selection box. This parameter is originally read from the scale and can be edited by users.

0	Disable this function
1	Fast display, good repeatability
2	Slower display, better repeatability
3	Slower display, better repeatability
4	Very slow display, very good repeatability

#### 3.6.2.9.2 Timeout

The Timeout defines the period (in seconds) after which the terminal stops attempting to perform a function that requires a no-motion condition (such as a zero, tare or print command) and aborts the function. This timeout is used regardless of the source of the command such as the keypad, discrete input, PLC or SICS. A smaller value means that less time will be used to check for no-motion before aborting a command. When a value of 0 is entered, there must be no-motion when a command is given or it will fail immediately. A value of 99 is a special condition which permits the terminal to wait indefinitely for a no-motion condition - a command would never be aborted.

0 - 99 seconds. Default: **3 seconds**



#### NOTICE

**When Terminal Tare is disabled, the stability timeout value defaults to 99, and cannot be modified.**

### 3.6.2.10 Log or Print

The Log or Print setup branch is where the thresholds to control how and when a demand data output is triggered. Normal demand mode printing occurs whenever a print request is made, providing there is no motion on the scale and the weight is above gross zero (a negative gross weight will not be printed).

The weight values entered are the gross weight values in primary units. Gross weight in primary units is used regardless of whether the terminal is in Gross or Net mode and regardless of the units that are displayed.

### 3.6.2.10.1 Minimum Weight

The minimum weight setting is the threshold below which log or print functions will not initiate. Primary units are displayed for this field. Enter the required value in primary weight units.

### 3.6.2.10.2 Interlock

Interlock prevents repeat logging and printing. When enabled, this interlock requires that the live weight reading be reset according to the Reset On parameter setting (see below). The live weight must then settle to a weight greater than the Minimum Weight value (see above) before responding to the next log or print request.

**Disabled** [default], Enabled

### 3.6.2.10.3 Automatic

This parameter triggers an automatic log and print request every time the weight on the scale settles to a positive value that is larger than the entered Threshold Weight value (see below). After the initial log or print, the automatic trigger must reset per the Reset On parameter setting (see below) before the next automatic log and print can occur. This parameter includes the following selections. Note that if Automatic is set to Disabled, the Threshold Weight field does not appear.

**Disabled** [default], Enabled

### 3.6.2.10.4 Reset On

The reset of Interlock and Automatic printing or logging can be based on weight threshold or weight deviation values. Select the desired operating mode and enter the weight value in the Reset On field. If both Interlock and Automatic settings are disabled, the Reset On field does not display. If Reset On is set to Deviation, the Threshold Weight and Motion Check fields do not display.

Deviation                      The weight must change more than this absolute value for the Interlock and Automatic print to reset.

**Return** [default]              The weight must return to below this value for the Interlock and Automatic print to reset.

### 3.6.2.10.5 Threshold Weight

The Threshold Weight is the value above which an Automatic logging or printing of data can/will be triggered. Threshold Weight does not appear if Automatic is set to Disabled or if Reset On is set to Deviation.

### 3.6.2.10.6 Motion Check

Enable the motion check setting to prevent interlock and automatic log and print functions from resetting when the scale is in motion below the Reset On return point. Motion Check does not appear if Reset ON is set to Deviation. Choices are:

**Disabled** [default], Enabled

### 3.6.2.11 MinWeigh

When the MinWeigh function is enabled, the current net weight is compared with MinWeigh Threshold to determine whether the weighing equipment selected for a particular measurement is adequate for the task.

#### 3.6.2.11.1 MinWeigh

1 To configure MinWeigh, follow the path Setup>Scale>MinWeigh or press the MINWEIGH softkey  in the Home Page.

Security level of the MINWEIGH softkey: Admin: Read / Write, Supervisor: Read / Write, Operator: Read

2 Refer to the table below to do the configuration.

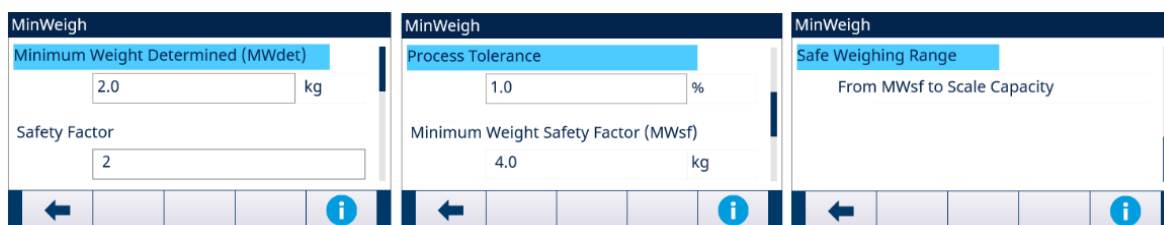

Figure 59: MinWeigh Configure

3 When a configuration item is in focus, press the INFORMATION softkey **i** to trigger a Popup Message Box to indicate some instruction about the focused configuration item.

Configuration Item	Parameter Description	Security	Comments
Minimum Weight Determined(MWdet)	<ul style="list-style-type: none"> <li>Weight for which the measurement uncertainty is equal to the process tolerance at the time of calibration</li> <li>MinWeigh operation can be disabled or enabled.</li> </ul>	<ul style="list-style-type: none"> <li>Admin: Read/Write</li> <li>Supervisor: Read/Write</li> <li>Operator: Read</li> </ul>	If this field is blank or filled with 0, MinWeigh is disabled. Even if MinWeigh is disabled, other following setting can still be visible and editable.
Safety Factor	<ul style="list-style-type: none"> <li>The safety factor in use to account for environmental influences on the weighing process over time</li> <li>1 ≤ Value ≤ 10, 1 [default]</li> </ul>	<ul style="list-style-type: none"> <li>Admin: Read/Write</li> <li>Supervisor: Read/Write</li> <li>Operator: Read</li> </ul>	-
Process Tolerance	<ul style="list-style-type: none"> <li>The relative weighing process tolerance applied to determine the Minimum Weight.</li> <li>0 [default], 1 to 100</li> </ul>	<ul style="list-style-type: none"> <li>Admin: Read/Write</li> <li>Supervisor: Read/Write</li> <li>Operator: Read</li> </ul>	Entered as a percentage
Minimum Weight Safety Factor (MWsf)	MWdet x Safety Factor	<ul style="list-style-type: none"> <li>Admin: Read</li> <li>Supervisor: Read</li> <li>Operator: Read</li> </ul>	The Value of MWdet * Safety Factor

### 3.6.2.11.2 MinWeigh Behavior

When MinWeigh is enabled, the MinWeigh Behavior page is used to configure the behavior in case of MinWeigh violation – Net Weight < MinWeigh.

1 To configure MinWeigh Behavior, follow the path Setup>Scale>MinWeigh>MinWeigh Behavior.

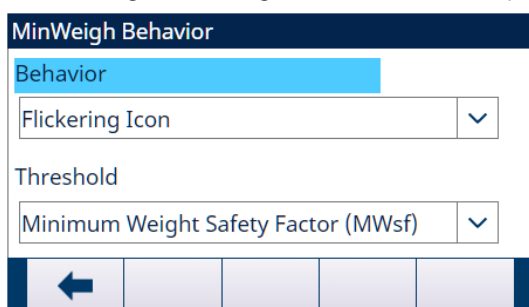

Figure 60: MinWeigh Behavior

2 Refer to the table below to do the configuration.

Configuration Items	Options	Security
Behavior	<ul style="list-style-type: none"> <li>Flickering Icon</li> <li>Flickering Icon and Grey Weight [default]</li> <li>Flickering Icon and No Weight</li> </ul>	<ul style="list-style-type: none"> <li>Admin: Read/Write</li> <li>Supervisor: Read/Write</li> <li>Operator: Read</li> </ul>

Configuration Items	Options	Security
Threshold	<ul style="list-style-type: none"> <li>Minimum Weight Determined(MWdet)</li> <li>Minimum Weight Safety Factor (MWSf) [default]</li> </ul>	<ul style="list-style-type: none"> <li>Admin: Read/Write</li> <li>Supervisor: Read/Write</li> <li>Operator: Read</li> </ul>

## Display

MinWeigh Disabled

No MinWeigh Icon is displayed, the weight displays as normal.



MinWeigh Enabled

- Net weight < MinWeigh Threshold
- MinWeigh Behavior: Flickering Icon



- Net weight < MinWeigh Threshold
- MinWeigh Behavior: Flickering Icon and Grey Weight



- Net weight < MinWeigh Threshold
- MinWeigh Behavior: Flickering Icon and No Weight



Net weight  $\geq$  MinWeigh Threshold

The MinWeigh icon shows but does not flicker.

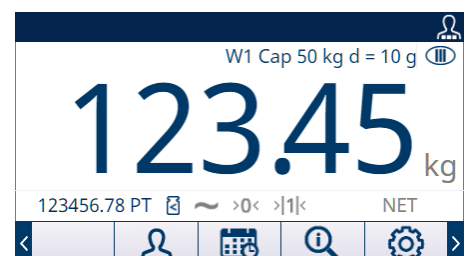



### 3.6.2.12 Reset

The Reset screen enables Scale branch setup values to be reset to factory default settings.

Note: Scale Reset does NOT include the reset of metrologically significant parameters – scale type, approval, weight units, capacity, increment, or calibration data. This data is reset only by performing a Master Reset with switch SW2-1 in its ON position, or a Reset function in the IDNet or SICSpro load cell.

### 3.6.2.12.1 Initiate Reset

- 1 Press the OK softkey  on the SCALE RESET screen to initiate scale reset, or press the EXIT softkey  to exit without resetting.
- 2 If the reset was successful, the message "Reset Successful" displays. If the reset was not successful, the message "Reset Failure" displays. If the reset fails, try to initiate the reset again. If the reset continues to fail, contact a local METTLER TOLEDO representative for assistance.

### 3.6.3 Scale - SICSpro

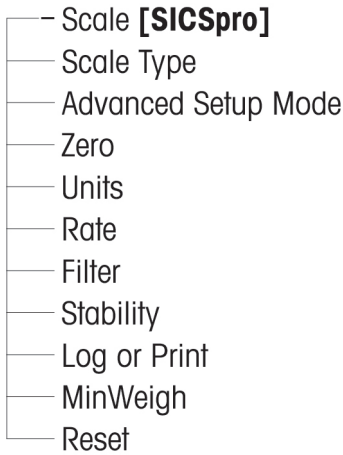

Figure 61 : Setup Menu of Scale - SICSpro

Metrological and some environmental parameters are accessed and stored in the load cell for the SICSpro interface. So the Scale branch has a reduced set of parameters. Access to the setup in the SICSpro load cell is called the Advanced Setup Mode and is accessible from a branch in the Scale block.

#### 3.6.3.1 Scale Type

The Scale Type screen permits a name to be assigned to the scale, displays the scale PCB type in the terminal, provides a selection list for the Approval mode, approval class and interval for the metrology line.

##### 3.6.3.1.1 Name

The Name field enables entry of the scale identification. Enter the scale name (an alpha-numeric string of up to 20 characters) in the Name entry box.

Default: **Scale 1**

##### 3.6.3.1.2 Scale Type

The Scale Type field indicates which type of scale this terminal supports.

Available option (s):

**SICSpro** [default for SICSpro version]

##### 3.6.3.1.3 Platform Serial Number

The platform Serial Number is shown as entered in the Advanced Setup Mode (ASM) of the load cell.

##### 3.6.3.1.4 Approval

The approval region of the system as programmed in the ASM of the load cell is shown.



#### NOTICE

**After setting the terminal to approved, and before exiting Setup, SW1-1 should be switched to ON. Take care when setting the switch in the powered terminal.**



### 3.6.3.1.5 Class

Class is shown if the base has been programmed as Approved. This is a display-only value as programmed in the scale.

Available option (s):

II, III, III HD, III L, IIII

### 3.6.3.1.6 Verified Interval

Verified Interval shows only when the scale is approved and Class has been selected as I.

The Verified Interval indicates if the approved increment size is equal to the displayed increment size or if it is 10 times the displayed increment size. This information is included in the data shown in the metrological line at the top of the display.

Available option (s):

e=d, e=10d

**Note: the Verified Interval is programmed in the ASM of the load cell.**

## 3.6.3.2 Advanced Setup Mode

The Advanced Setup Mode provides access to program settings in the load cell. Refer to the manual of the SICSpro platform being connected for details of the setup steps included in ASM.

The following figure provides an overview of the current ASM menu structure. **Note that the ASM menu can only display in English.**

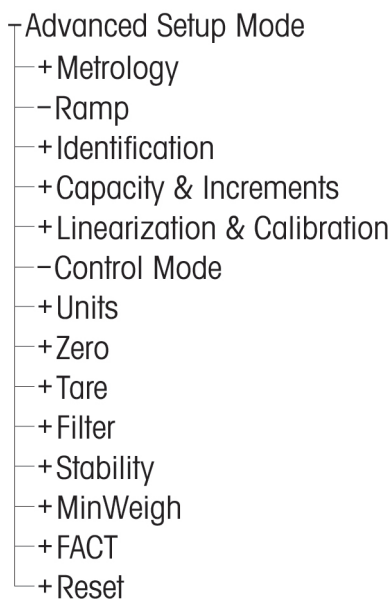

Figure 62: Advanced Setup Menu Basic Menu Structure

### 3.6.3.3 Zero

This section provides access to Timed Zero settings.

#### 3.6.3.3.1 Timed Zero

When enabled, the Timed Zero function monitors the weighing system to ensure that the system sees the center of zero condition at stability within a certain pre-determined time or the scale is disabled.

It is strongly recommended to leave Timed Zero disabled (default condition) unless the application/installation requires MID R51 approval for automatic catchweighing equipment.

Available option (s):

**Disabled** [default], 10 minutes, 15 minutes, 30 minutes

### 3.6.3.4 Units

The Units screen enables the selection of a second and a third unit and determines which unit is used at power up. If printing of two units is required, establish Third Units. Both Primary and Third units can be printed simultaneously in an output template.

#### 3.6.3.4.1 Second Unit

Use the Second Unit selection box to select a second weighing unit. Only one custom unit is possible.

Available option (s):

**None** [default], Custom

#### 3.6.3.4.2 Host/Auxillary Unit

Use the Host / Auxillary Unit selection box to select a third weighing unit.

Available option (s):

**None** [default], Custom

#### 3.6.3.4.3 Custom Factor

This parameter only appears if a Custom unit is selected. Enter a multiplication factor for the custom unit in this field, such as 0.592 or 1.019. The primary unit is multiplied by the custom factor to obtain the custom value.

#### 3.6.3.4.4 Custom Name

This parameter only appears if a Custom unit is selected. Use the alpha keys to enter the name for the custom unit. Up to 12 characters may be entered. The terminal displays the first five letters of the custom name in the units area of the display when custom units are in use.

#### 3.6.3.4.5 Custom Increment

This parameter only appears if a Custom unit is selected. Enter a custom increment in this field, such as 0.1 or 0.5. This step controls both the decimal position and the increment size of the custom unit value.

### 3.6.3.5 Rate

A Rate, expressed as change in primary or secondary weight units per time unit, may be programmed for display on the terminal and/or used in controlling discrete outputs – for example as the source for a Comparator (refer to Configuration and Operation for more details).

Note: the Rate display is selectable for display in the auxiliary display area below the weight display. Refer to [Auxiliary Display ▶ Page 111] for more information on using the auxiliary display.

If the weight information in the terminal becomes invalid, the Rate display will show 0.000.

#### 3.6.3.5.1 Weight Units

Weight Units define which weight unit will be used for the rate calculation.

Available option (s):

<b>None</b> [default]	Rate function is disabled.
Primary	Primary weight units are used.
Secondary	Secondary weight units are used. A secondary unit must be enabled for this choice to be shown.

#### 3.6.3.5.2 Time Units

Time Units determine what time reference will be used for the rate value.

Available option (s):

**Seconds** [default], Minutes, Hours

#### 3.6.3.5.3 Measurement Period

The Measurement Period value sets the frequency of weight measurements.

Available option (s):

0.5 seconds, **1 second** [default], 5 seconds

#### **3.6.3.5.4 Output Average**

Output from the rate function is set by a computed rolling average of measurements. The Output Average value should be sufficiently larger than the Measurement Period to allow the terminal to take multiple measurements for each average.

Value range:

1 - 99 seconds. Default: **5 seconds**

#### **3.6.3.6 Stability**

For SICSpro bases, a timeout period may be set.

##### **3.6.3.6.1 Timeout**

The Timeout defines the period (in seconds) after which the terminal stops attempting to perform a function that requires a no-motion condition (such as a zero, tare or print command) and aborts the function. This timeout is used regardless of the source of the command such as the keypad, discrete input, PLC or SICS. A smaller value means that less time will be used to check for no-motion before aborting a command. When a value of 0 is entered, there must be no-motion when a command is given or it will fail immediately. A value of 99 is a special condition which permits the terminal to wait indefinitely for a no-motion condition - a command would never be aborted.

Value range:

0 - 99 seconds. Default: **3 seconds**

#### **3.6.3.7 Log or Print**

The Log or Print setup branch is where the thresholds to control how and when a demand data output is triggered. Normal demand mode printing occurs whenever a print request is made, providing there is no motion on the scale and the weight is above gross zero (a negative gross weight will not be printed).

The weight values entered are the gross weight values in primary units. Gross weight in primary units is used regardless of whether the terminal is in Gross or Net mode and regardless of the units that are displayed.

##### **3.6.3.7.1 Minimum Weight**

The minimum weight setting is the threshold below which log or print functions will not initiate. Primary units are displayed for this field. Enter the required value in primary weight units.

##### **3.6.3.7.2 Interlock**

Interlock prevents repeat logging and printing. When enabled, this interlock requires that the live weight reading be reset according to the Reset On parameter setting (see below). The live weight must then settle to a weight greater than the Minimum Weight value (see above) before responding to the next log or print request.

Available option (s):

**Disabled** [default], Enabled

##### **3.6.3.7.3 Automatic**

This parameter triggers an automatic log and print request every time the weight on the scale settles to a positive value that is larger than the entered Threshold Weight value (see below). After the initial log or print, the automatic trigger must reset per the Reset On parameter setting (see below) before the next automatic log and print can occur. This parameter includes the following selections. Note that if Automatic is set to Disabled, the Threshold Weight field does not appear.

Available option (s):

**Disabled** [default], Enabled

### 3.6.3.7.4 Reset On

The reset of Interlock and Automatic printing or logging can be based on weight threshold or weight deviation values. Select the desired operating mode and enter the weight value in the Reset On field. If both Interlock and Automatic settings are disabled, the Reset On field does not display. If Reset On is set to Deviation, the Threshold Weight and Motion Check fields do not display.

Available option (s):

- Deviation                      The weight must change more than this absolute value for the Interlock and Automatic print to reset.
- Return [default]**            The weight must return to below this value for the Interlock and Automatic print to reset.

### 3.6.3.7.5 Threshold Weight

The Threshold Weight is the value above which an Automatic logging or printing of data can/will be triggered. Threshold Weight does not appear if Automatic is set to Disabled or if Reset On is set to Deviation.

### 3.6.3.7.6 Motion Check

Enable the motion check setting to prevent interlock and automatic log and print functions from resetting when the scale is in motion below the Reset On return point. Motion Check does not appear if Reset ON is set to Deviation. Choices are:

Available option (s):

- Disabled [default]**, Enabled

### 3.6.3.8 MinWeigh

When the MinWeigh function is enabled, the current net weight is compared with MinWeigh Threshold to determine whether the weighing equipment selected for a particular measurement is adequate for the task.

#### 3.6.3.8.1 MinWeigh



- 1 To configure MinWeigh, follow the path Setup>Scale>MinWeigh or press the MINWEIGH softkey  in the Home Page.  
Security level of the MINWEIGH softkey: Admin: Read / Write, Supervisor: Read / Write, Operator: Read
- 2 Refer to the table below to do the configuration.



Figure 63: MinWeigh Configure

- 3 When a configuration item is in focus, press the INFORMATION softkey  to trigger a Popup Message Box to indicate some instruction about the focused configuration item.

Configuration Item	Parameter Description	Security	Comments
Minimum Weight Determined(MWdet)	<ul style="list-style-type: none"> <li>• Weight for which the measurement uncertainty is equal to the process tolerance at the time of calibration</li> <li>• MinWeigh operation can be disabled or enabled.</li> </ul>	<ul style="list-style-type: none"> <li>• Admin: Read/Write</li> <li>• Supervisor: Read/Write</li> <li>• Operator: Read</li> </ul>	If this field is blank or filled with 0, MinWeigh is disabled. Even if MinWeigh is disabled, other following setting can still be visible and editable.
Safety Factor	<ul style="list-style-type: none"> <li>• The safety factor in use to account for environmental influences on the weighing process over time</li> <li>• 1 ≤ Value ≤ 10, 1 [default]</li> </ul>	<ul style="list-style-type: none"> <li>• Admin: Read/Write</li> <li>• Supervisor: Read/Write</li> <li>• Operator: Read</li> </ul>	-

Configuration Item	Parameter Description	Security	Comments
Process Tolerance	<ul style="list-style-type: none"> <li>The relative weighing process tolerance applied to determine the Minimum Weight.</li> <li>0 [default], 1 to 100</li> </ul>	<ul style="list-style-type: none"> <li>Admin: Read/Write</li> <li>Supervisor: Read/Write</li> <li>Operator: Read</li> </ul>	Entered as a percentage
Minimum Weight Safety Factor (MWsf)	MWdet x Safety Factor	<ul style="list-style-type: none"> <li>Admin: Read</li> <li>Supervisor: Read</li> <li>Operator: Read</li> </ul>	The Value of MWdet * Safety Factor

### 3.6.3.8.2 MinWeigh Behavior

When MinWeigh is enabled, the MinWeigh Behavior page is used to configure the behavior in case of MinWeigh violation – Net Weight < MinWeigh.

1 To configure MinWeigh Behavior, follow the path Setup>Scale>MinWeigh>MinWeigh Behavior.

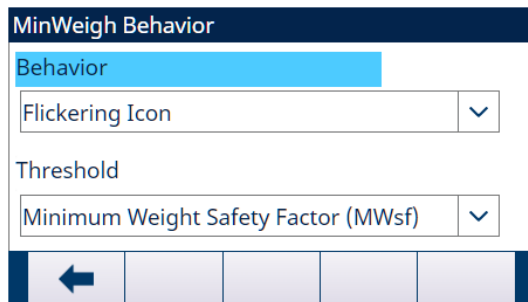

Figure 64: MinWeigh Behavior

2 Refer to the table below to do the configuration.

Configuration Items	Options	Security
Behavior	<ul style="list-style-type: none"> <li>Flickering Icon</li> <li>Flickering Icon and Grey Weight [default]</li> <li>Flickering Icon and No Weight</li> </ul>	<ul style="list-style-type: none"> <li>Admin: Read/Write</li> <li>Supervisor: Read/Write</li> <li>Operator: Read</li> </ul>
Threshold	<ul style="list-style-type: none"> <li>Minimum Weight Determined(MWdet)</li> <li>Minimum Weight Safety Factor (MWsf) [default]</li> </ul>	<ul style="list-style-type: none"> <li>Admin: Read/Write</li> <li>Supervisor: Read/Write</li> <li>Operator: Read</li> </ul>

### Display

MinWeigh Disabled

No MinWeigh Icon is displayed, the weight displays as normal.



- MinWeigh Enabled
- Net weight < MinWeigh Threshold
  - MinWeigh Behavior: Flickering Icon



- Net weight < MinWeigh Threshold
- MinWeigh Behavior: Flickering Icon and Grey Weight



- Net weight < MinWeigh Threshold
- MinWeigh Behavior: Flickering Icon and No Weight



Net weight  $\geq$  MinWeigh Threshold

The MinWeigh icon  shows but does not flicker.





### 3.6.3.9 Reset

The Reset screen enables Scale branch setup values to be reset to factory default settings.

Note: Scale Reset does NOT include the reset of metrologically significant parameters – scale type, approval, weight units, capacity, increment, or calibration data. This data is reset only by performing a Master Reset with switch SW2-1 in its ON position, or a Reset function in the IDNet or SICSpro load cell.

#### 3.6.3.9.1 Initiate Reset

- 1 Press the OK softkey  on the SCALE RESET screen to initiate scale reset, or press the EXIT softkey  to exit without resetting.
- 2 If the reset was successful, the message "Reset Successful" displays. If the reset was not successful, the message "Reset Failure" displays. If the reset fails, try to initiate the reset again. If the reset continues to fail, contact a local METTLER TOLEDO representative for assistance.

## 3.7 Application

### 3.7.1 Memory

#### 3.7.1.1 Alibi

The Alibi memory table stores basic transaction information that is not user-definable. Alibi memory is configured as a "ring" buffer that overwrites the oldest record when it reaches its memory limit. Alibi memory can hold approximately 100,000 transactions before it reaches its limit and begins overwriting old transactions. The selections are:

Disabled [default], Enabled

More detailed information about Alibi memory can be found in [Alibi Memory Direct Access ▶ Page 56] and in [Table and Log File Structure ▶ Page 198].



#### NOTICE

**If the IND500x terminal has been programmed as "approved", Alibi memory enabling or disabling is only accessible if the security switch (SW1-1) is in the OFF position.**

**The Alibi memory can not be cleared unless a Factory Reset is implement. Refer to PCB Switch Settings for more information on Factory Reset.**

#### See also

[Operation ▶ Page 21](#)



#### 3.7.1.1.1 View and Print Alibi Memory



- 1 Press the VIEW TABLE softkey .

➔ The Alibi screen displays.

Alibi			
Date	Time	Transaction	Gross W
04-Aug-2020	11:06:25	0000003	6.35
04-Aug-2020	11:07:25	0000004	13.98
04-Aug-2020	11:08:25	0000005	13.55
04-Aug-2020	11:09:02	0000006	2.20

Figure 65: Alibi

- 2 Press the FILTER OFF softkey .
- 3 Use the selection boxes and data entry fields to enter specific search information to limit the search, or do not enter any search limits to view all Alibi Memory Table information.
- 4 Press the OK softkey .
  - ➔ The filtered search results are shown. Records are ordered by date and time with the most recent record shown last.
- 5 Use the navigation keys to view the records: Date, Time, Transaction, Gross Weight, Net Weight, Tare Weight, Preset Tare, and Unit. Note: In the column of Preset Tare, "PT" is shown if the transaction uses a preset tare.
 

In this screen, user can press the FILTER ON softkey  to renew the search information, or press the FILTER CLEAR softkey  to clear the search information.

Date	Time	Transaction	Gross Weight	Net Weight	Tare Weight	Preset Tare	Unit
04-Aug-2020	11:06:25	0000003	6.35	6.00	0.35		kg
04-Aug-2020	11:07:25	0000004	13.98	13.00	0.98	PT	kg
04-Aug-2020	11:08:25	0000005	13.55	13.00	0.55		oz
04-Aug-2020	11:09:02	0000006	2.20	2.20	0.00		Custom

Figure 66: Records

- 6 Press the TRANSFER softkey  on this screen to print the entire selected Alibi Memory Table.

### 3.7.1.2 Tare Table

For convenience of calling predefined Tare values or Container Tare for use within a sequence of operation, Tare Table is introduced to store these predefined Tare values or Container Tare Limits which can be quickly recalled by the operator, instead of manually entering them for each transaction. This is especially useful when certain Tare values are used repeatedly.

The IND500x contains a Tare Table with 199 records for storing tare weights.

- 1 Press the SETUP softkey  in the Home Page.
- 2 To find the Tare Table branch, follow the path: Setup>Application>Memory>Tare Table.
  - ➔ The Tare Table page shows.

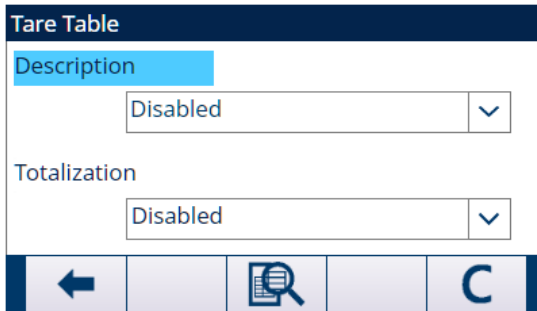

Figure 67: Tare Table

- 3 Configure the Tare Table with below parameters.

#### Description

Description is an alphanumeric string that describes the Tare Table entry. User can select in this field to Enable or Disable Description in the Tare Table structure.

Options: **Disabled**, Enabled

#### Totalization

Totalization is a field that tracks the total weight for all transactions involving each tare in the table.



Options: **Disabled**, Gross Weight, Displayed Weight

- 4 In the Tare Table page, press the CLEAR softkey  to clear the Tare Table.



#### 3.7.1.2.1 View Tare Table Records

Depending on the selections made in setup, Tare Table records can include the following fields:

ID	Identification number for the active record
Value	Desired preset tare value or Container Tare Value
Unit	Units of measure for the tare (tare record units can be any available primary unit)
Low Limit	Used for Container Tare Checking.
Upper Limit	Used for Container Tare Checking.
Description	Descriptive identification for the active record
n	Number of transactions in which the tare record is used.
Total	Accumulated weight of all transactions using the tare ID.

- 1 In the Tare Table page, press the VIEW TABLE softkey .
  - ➔ The Tare Search page shows.
- 2 Press the FILTER OFF softkey .
- 3 Use the selection boxes and associated fields to enter specific search information to limit the search, or enter \* (the "find all" character) to view all Tare Table information.
- 4 Press the OK softkey .
  - ➔ The Tare Search View screen displays the search results. Only records with non-null tare values display. Records are ordered by ID, with the lowest ID number shown first.



- 5 Press the UP, DOWN, LEFT, and RIGHT navigation keys to scroll up and down and across the screen in order to view all data and all records listed. In this screen, user can press the FILTER ON softkey  to renew the search information, or press the FILTER CLEAR softkey  to clear the search information.

### 3.7.1.2.2 Edit or Add A Tare Table Record





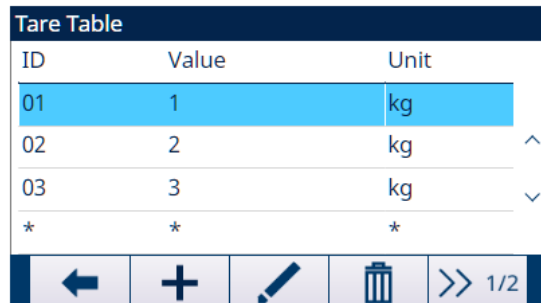



An existing Tare Record in Tare Table can be edited and a new Tare Record can be added.

- 1 Press the UP and DOWN navigation keys to select (highlight) a record in the table.



ID	Value	Unit
01	1	kg
02	2	kg
03	3	kg
*	*	*

Figure 68: Tare Table Record

- 2 Press the EDIT softkey  to open the setup screen for editing a record or press the ADD softkey  to open the setup screen to create a new table record.
- 3 Press the UP and DOWN navigation keys to move the focus to the field name to be edited or inserted.
- 4 Press the ENTER key to select a field value to edit or insert.
- 5 Use the numeric keypad to edit or enter the desired value.
- 6 When the tare entry field is highlighted, press the TARE softkey  to capture the current live scale weight and unit.
- 7 Press the OK softkey  to accept the modifications or additions to the Tare Table.
- 8 Press the EXIT softkey  to return to the previous page without saving modifications or additions.
- 9 Press the DELETE softkey  to delete a tare record in the list.
- 10 Press the TRANSFER softkey  to generate Tare Table reports.
- 11 Press the EXIT softkey  to exit the current page.

### 3.7.1.3 Message Table

The Message Table shows stored text messages and corresponding ID numbers that can be used in print templates. Only message records with non-null values show.



- 1 Press the SETUP softkey  in the Home Page.
- 2 To find the **Message Table** branch, follow the path: Setup>Application>Memory>**Message Table**.  
➔ The **Message Table** page shows.

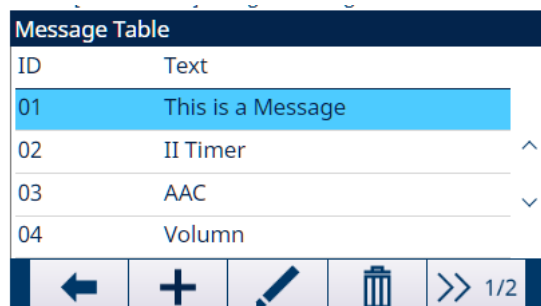

#### View Message Table Records









ID	Text
01	This is a Message
02	II Timer
03	AAC
04	Volumn

Figure 69: Message Table

- 1 Press the NEXT softkey .
- 2 In the next **Message Table** page, press the FILTER OFF softkey .
- 3 In the Filter Settings page, use the selection boxes and data entry fields to enter specific search information to limit the search, or do not enter any search limits to view all **Message Table** records.

- 4 Press the OK softkey .
  - ➔ The filtered message records show. Records are ordered by date and time with the most recent record shown last.
  - ➔ Press the UP, DOWN, LEFT, and RIGHT navigation keys to scroll up and down and across the screen in order to view all data and all records listed. In this screen, user can press the FILTER ON softkey  to renew the search information, or press the FILTER CLEAR softkey  to clear the search information.

### Edit or Add A Message Table Record

- 1 Press the EDIT softkey  to open the setup screen for editing a record or press the ADD softkey  to open the setup screen to create a new table record.
- 2 Press the UP and DOWN navigation keys to move the focus to the field name to be edited or inserted.
- 3 Press the ENTER key to select a field value to edit or insert.
- 4 Use the numeric keypad to edit or enter the desired value.
- 5 Press the OK softkey  to accept the modifications or additions to the Message Table.
- 6 Press the EXIT softkey  to return to the previous page without saving modifications or additions.
- 7 Press the DELETE softkey  to delete a message record in the list.
- 8 Press the TRANSFER softkey  to generate Message Table reports to any connection with a Reports assignment.
  - ➔ If no Report Connection is available, the message “**No Report Connection**” shows.
- 9 Press the EXIT softkey  to exit the current page.

### Quick Search

When ID of the Message Table record to be loaded is known, the Quick Recall mode is to be used.

- 1 In the **Message Table** screen, use the numeric keypad to enter the ID and then press ENTER key to load the record.
  - ➔ If the record is available, the data is loaded.
  - ➔ If the record is not found, a message “ID not found” shows.
- 2 Press the OK softkey .
  - ➔ A record is searched.



## 3.7.2 Operation





### 3.7.2.1 Comparators

Comparators are simple targets. Other module / application could use its result to control peripheral or self-workflow.

For example, if a target is reached, a discrete output is turned on or off. This feature is used to actively control gates, valves, lights or other type of control elements. A life data source (weight, count, flow rate...) is compared to the entered target or range. The target or range is assigned to a mathematical equation (operator). If the equation is true, the output is switched according to the configured operator. For more details about operation, see [Comparators ▶ Page 55].

## Setup

Parameters Configuration		
Parameter	Options	Description
Source	None	Comparator is Disabled.
	Application	Comparator is controlled by a TaskExpert program.
	ABS – Displayed Weight	Comparator is triggered on the absolute value of the displayed weight (no consideration of whether the value is positive or negative).
	ABS – Rate	Comparator is triggered on the absolute value of the rate (no consideration of whether the value is positive or negative).
	Displayed Weight	Comparator is triggered on the displayed weight.
	Gross Weight	Comparator is triggered on the gross weight.
	Rate	Comparator is triggered on the rate.
Operator	<	Comparator is ON when the source value is less than the limit.
	≤	Comparator is ON when the source value is less than or equal to the limit.
	=	Comparator is ON when the source value is equal to the limit.
	>	Comparator is ON when the source value is greater than the limit.
	< >	Comparator is ON when the source value is not equal to the limit.
	_< >_	Comparator is ON when the source value is outside the range of the limit and the high limit.
	> _<	Comparator is ON when the source value is within the range of the limit and the high limit.
Description	-	<ul style="list-style-type: none"> <li>The description is an alphanumeric string that is used to identify the type and purpose of the comparator.</li> <li>This string appears, together with the automatically assigned ID number (1-5), in the list that shows when the COMPARATORS softkey  is pressed. The maximum length is 20 characters.</li> </ul>
Limit	-	The Limit either sets the comparison value to which the actual source value is compared, or the lower comparison value for the range to which the currently measured source value is compared.
High Limit	-	<ul style="list-style-type: none"> <li>The High Limit is available only for Range mode, and sets the upper comparison value for the range to which the currently measured source value is compared.</li> <li>Its value must be higher than the Limit. If a lower value is entered, the terminal will show an Invalid Value message when the OK softkey  is pressed.</li> </ul>

- 1 Press the SETUP softkey  in the Home Page.
- 2 To find the Comparators branch, follow the path: Setup>Application>Operation>Comparators.  
➔ The Comparators page shows all five Comparators.
- 3 In the Comparators page, press the EDIT softkey  to configure the parameters of specific ID. See table **Parameters Configuration**.  
In this page, user can also press the DELETE softkey  to delete a Comparator ID, and press the CLEAR softkey  to clear all Comparators.
- 4 Configure the COMPARATORS softkey  in the Softkeys page (path: Setup>Terminal>Softkeys).

- Go back to the Home Page. The COMPARATORS soffkey  shows in the bottom column of the Home Page.

### 3.7.2.2 Totalization

The IND500x terminal provides totalization in both Grand Total (GT) and Subtotal (ST) registers and counters.

#### Setup

#### Totalization Configuration

Category	Configuration Item	Options	Effect
Grand Total (GT)	Mode	<b>Disabled</b>	The Totalization function (GT and ST) is disabled.
		Gross Weight	Demand Print weight (gross weight) is added to GT.
		Net Weight	Demand Print weight (net weight) is added to GT.
	Clear GT on Print	<b>Disabled</b>	The function is disabled.
Enabled		GT and ST registers clear automatically on Totals report print.	
Subtotal (ST)	Subtotal	<b>Disabled</b>	The ST register is separately disabled while the GT register continues to accumulate weights.
		Enabled	Demand Print weight (gross weight or net weight) is added to ST.
	Clear ST on Print	<b>Disabled</b>	The function is disabled.
		Enabled	If this feature is disabled for GT, ST registers clear automatically on Totals report print while GT registers continue to track the grand total of weight.
Totalization Unit	-	g/kg/lb/t/ton/oz	-

Note: The option in bold indicates the default value.

- To find the Totalization branch, follow the path: Setup>Application>Operation>Totalization.  
 ➔ The Totalization setup page shows.

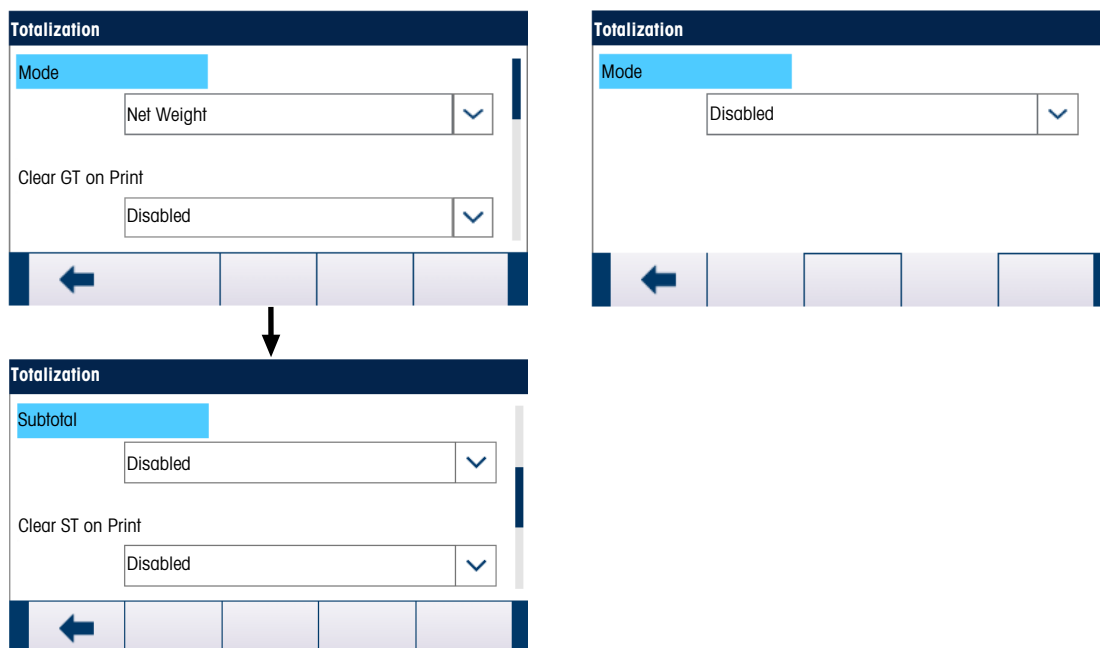

Figure 70: Mode Selection

- To do the Totalization configuration, refer to the table **Totalization Configuration**.
- Select the Totalization Unit (g/kg/lb/t/ton/oz) in the dropdown menu.

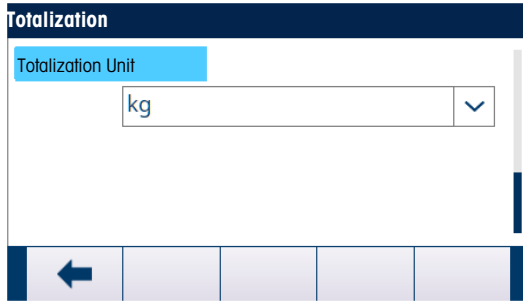

Figure 71: Totalization Unit

### Operation

- Each time the Demand Print is triggered, the Demand Print weight is added to both the Grand Total and Subtotal weight registers.
- The counters and totals are unaffected by a duplicate ticket printing request (Repeat Print).
- Counters have a limit of 1,500,000 and registers accumulate up to 11 digits of weight including any decimal places to the right of the decimal point. For example, a scale programmed for 500 x 0.1 kg will accumulate weight values up to 999999999.9 (11 total digits). If either of these limits is exceeded, an error message shows and the totals must be reset before additional weights or counts are added.

### 3.7.2.3 ID1, ID2, ID3 and ID4

The ID1, ID2, ID3 and ID4 function are simple but powerful means of facilitating specific data input from the operator or causing a specific action to take place. The ID prompt list may include up to 30 steps, each step containing a command that determines the action the IND500x terminal will take when the step is executed.

All four sequences can be programmed to run through once or to loop continuously until terminated. All IDs can be initiated by the pressing the appropriate ID softkey. ID1 can also be initiated and restarted automatically, triggered by weight input from the scale. In either case, the IDs prompt the operator to work through a series of actions or data entries. For example, the operator could place a package on the scale, be prompted to enter his or her name, enter a pre-set tare value, scan a bar code on the package, and generate an automatic print before finally removing the package from the scale. The printed data could include the net weight value, together with the scanned package information and the operator name. The content and format of the printed information is determined by the template assigned to the demand output.

### Setup

For an ID prompt to work, its ID Mode must be enabled in setup, at Application>Operation>ID1, ID2, ID3 or ID4.

#### ID Mode – Automatic



Figure 72: ID Mode - Automatic

The Automatic mode is only available in ID1.

When ID1 is set to Automatic mode, the ID sequence is triggered when the weight on the scale (**must be stable**) exceeds the threshold configured in the Threshold field. The sequence trigger is rearmed when the weight falls below the Reset value. Both Threshold and Reset value are  $\geq 0$ .

## ID Mode – Softkey

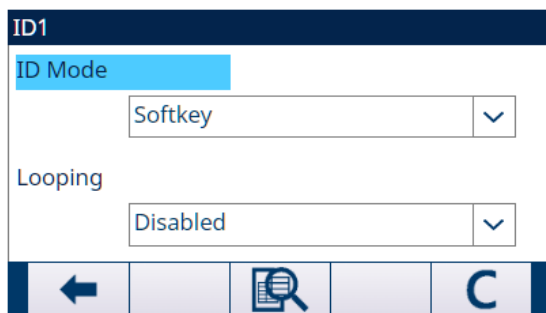









Figure 73: ID Mode - Softkey

The Softkey mode is available for all IDs.

In this mode, the prompting sequence begins to run when the related softkey (ID1, ID2, ID3 or ID4) is pressed, and either runs once (Looping is Disabled) or runs continuously (Looping is Enabled).

### Configure ID Sequence Steps

Once the Mode Parameters are set, ID1, ID2, ID3 and ID4 sequence steps can be viewed, created, edited or deleted by pressing the VIEW TABLE softkey .

- 1 In the ID View page, press the FILTER OFF softkey .
- 2 In the Filter Settings page, select #, Type, Length or Prompt as the search object.
- 3 Either select a field to search by entering a comparative operator (<, <=, =, >=, >, <>) and alphanumeric information in the Data fields; or leave the wildcard asterisk (\*) in the Data field to view all existing steps.
- 4 Press the OK softkey .
  - ➔ The filtered ID results show.
- 5 ID steps can be edited , created , deleted  and transferred .
  - ➔ The # (step number) is automatically assigned. It determines the order in which the steps will execute. Steps may be inserted into an existing sequence by selecting an entry and pressing the ADD softkey  to define a new step. The newly created step will appear in the sequence before the selected entry, and all subsequent # values will increase by one. To move a step in the sequence, it must be deleted and re-entered in the appropriate position.
  - ➔ The parameters that can be set for each step depend on the Type of step selected. See table **Types of ID Steps**.

Types of ID Steps		
Type	Parameters	Description
<ul style="list-style-type: none"> <li>• Alphanumeric</li> <li>• Numeric</li> </ul>	Prompt	Up to 30 characters can be entered as the text or prompt for the step to show on screen during the ID sequence.
	Length	Numeric value (0 - 40) can be entered to constrain the length of the response input after the prompt.  If length of 0 is entered, the prompt is shown without an entry field. The step is then displayed as an instruction in the sequence. In this case, ENTER must be pressed to move to the next step. During entry, once the length value is met, the terminal will not accept further input; incorrect entries can be deleted with the CLEAR key.
	Clear Data	The entered response (e.g., Operator name) can be retained from one cycle to the next.  Disabled - the next time the step displays, it contains the data entered during the previous cycle. Pressing ENTER accepts the value and moves to the next step or making any entry to overwrite the previous data.  Enabled - the entry field will be blank when viewed the next time.

Types of ID Steps		
Type	Parameters	Description
<ul style="list-style-type: none"> <li>Clear Tare</li> <li>Print</li> <li>Tare - Auto</li> </ul>	-	The selected function is executed automatically.
<ul style="list-style-type: none"> <li>Selection List</li> </ul>	Prompt	Same as type Alphanumeric and type Numeric.
	# of Selections	The number of choices in the selection box can be set from 2 to 6.
	Clear Data	Disabled - retains the previous selection as the beginning point for the next cycle. Enabled – the selection list will restart at the first selection in the next cycle.
<ul style="list-style-type: none"> <li>Tare - Preset</li> </ul>	Prompt	Same as type Alphanumeric and type Numeric.
	Length	Same as type Alphanumeric and type Numeric.
	Clear Data	Same as type Alphanumeric and type Numeric.

### 3.7.3 Discrete I/O

A Discrete I/O (DIO) subsystem performs a mapping of internal Boolean variables and external, real world signals. DIO may include level shifting circuitry, isolation, miswiring protection, and surge voltage protection. It always includes a physical location for the termination of field control wiring. The DIO electronics and termination area may be mounted inside the local equipment enclosure ("local" DIO) or can be in a remote area ("remote" DIO), connected to the primary equipment via serial link.



IND500x supports 3 types Location of IN/OUT:

- Local 1: 3 In 3 Out is mounted on the mainboard.
- Local 2: 5 In 8 Out is an option board that can be plugged in the mainboard.
- Remote 1, Remote 2 and Remote3 are remote ARM100 IN/OUT, and can be accessed by Modbus Rtu Master(mainboard) with Modbus Rtu protocol via RS485.

#### 3.7.3.1 Input

An input can be used to initiate a command, for example to apply a semi-automatic tare. Commands are triggered by change of state. An input can also be used to sense a condition, such as a discharge gate closure.

Input Assignment Selections			
None	Disable Setup	ID4	Unit Switching
Blank Display	Enter Key	Print	Zero
Clear Tare	ID1	SmartTrac	Unit - Primary
Clear System Alarm	ID2	Tare	Unit - Second
Disable Keypad	ID3	Trigger 1 - 3	Unit - Third

- 1 Press the Setup softkey  in the Home Page.
- 2 To find the Inputs branch, follow the path: Setup>Application>Discrete I/O>Inputs
- 3 In the Inputs page, press the EDIT softkey  to open the setup page for editing an existing input assignment or press the ADD softkey  to add a new discrete input assignment.

4 Enter the input assignment address.

**Location:** This field defines the Input is local or remote.

**Position:** This field defines position of the discrete input option assigned to a function.

Figure 74: Discrete Input Edit

5 Select the Polarity as +True or -True.

Figure 75: Discrete Input Edit

6 To select an input assignment, refer to the table **Input Assignment Selections**.

7 Press the OK softkey to confirm the entry.

8 In the Discrete Inputs page, press the DELETE softkey to delete a specific input assignment and press the CLEAR softkey to clear the entire table.

### 3.7.3.2 Output

An output can be used to declare the state of an internal Boolean variable, for example the state of motion bit, or the Target Comparison feed state.

Output Assignment Selections			
None	Comparator 3	Tolerance OK	Under Zero
Center of Zero	Comparator 4	System Error Alarm	Zero Requested
Comparator 1	Comparator 5	System OK	Under Zone
Comparator 2	Motion	Net	Over Zone
Over Capacity	Out of Tolerance	-	-

1 Press the Setup softkey in the Home Page.

2 To find the Outputs branch, follow the path: Setup>Application>Discrete I/O>Outputs

3 In the Outputs page, press the EDIT softkey to open the setup page for editing an existing output assignment or press the ADD softkey to add a new discrete output assignment.



- 4 Enter the output assignment address.

**Location:** This field defines the Output is local or remote.

**Position:** This field defines position of the discrete output option assigned to a function.

Figure 76: Discrete Output Edit

- 5 To select an output assignment, refer to the table **Output Assignment Selections**.

Figure 77: Discrete Output Edit

- 6 Press the OK softkey to confirm the entry.
- 7 In the Discrete Outputs page, press the DELETE softkey to delete a specific output assignment and press the CLEAR softkey to clear the entire table.

### 3.7.4 TaskExpert

A custom TaskExpert program that is loaded into the IND500x can be enabled from this screen. It is also used to access custom setup screens defined by the TaskExpert application.

The TaskExpert is enabled through the use of an “application hardware key.” The key is inserted into a receptacle on the IND500x main board. It contains a specific code that enables access to the features and capabilities of this specific application solution.

User can find the TaskExpert branch in the path: Setup>Application>TaskExpert.

#### Start

In the TaskExpert Start page, user can list TaskExpert programs and associate each of them to a Task number. Each task can be set to run automatically at terminal power-up, automatically after exiting Setup, or start manually with the TASK LIST softkey , TASK 1 softkey , TASK 2 softkey or TASK 3 softkey .



- 1 In the TaskExpert View page, press the EDIT softkey to modify an existing record. The Task number can't be modified.
- 2 Press the DELETE softkey to delete a specific record and press the CLEAR softkey to clear the entire Task List.
- 3 To create a new Task, press the ADD softkey .
  - ➔ The TaskExpert Edit page shows. The Task Number is assigned automatically.
- 4 Enter the TaskExpert File Name.
- 5 Select to Enable or Disable Auto Start.
  - Enabled: The Task runs each time the indicator is powered up or when Setup is exited.
- 6 Select to Enable or Disable Manual Start.
  - Enabled: The task runs when manually selected and started.
- 7 Press OK softkey to save changes or EXIT softkey to exit without saving.

## Custom Setup

The Custom Setup menu is defined by the TaskExpert application. For details, refer to the TaskExpert Application Manual, provided with TaskExpert.

### 3.7.5 Reset

The Reset function returns most configuration settings in the Application branch to their factory defaults. Application>Reset does NOT include the reset of information stored in Alibi Memory or tables. This data can only be reset by executing the Reset All function found at Maintenance>Reset All.

- 1 To initiate a Reset, press the OK softkey .
  - ➔ If the Reset is successful, the verification message "Reset Successful" shows.
  - ➔ If the Reset is not successful, the error message "Reset Failure" shows.
- 2 If the Reset fails, try to initiate the Reset again.
- 3 If the Reset continues to fail, contact a local METTLER TOLEDO representative for assistance.
- 4 Press the EXIT softkey  to exit without resetting.

## 3.8 Terminal

The configuration screens for the Terminal branch of setup are shown below. If user security is enabled, Login must be at Maintenance level or above to access most parameters in the Terminal branch. A Supervisor can set the time and date.

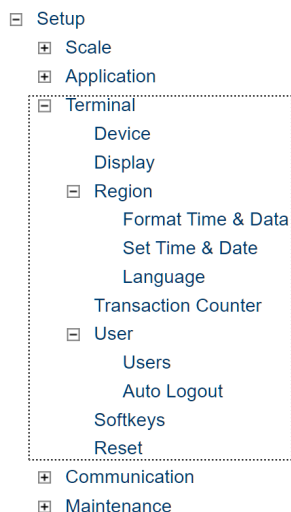



Figure 78: Setup Tree

### 3.8.1 Device



The Device setup screen enables the entry of three terminal IDs and the terminal serial number.

#### 3.8.1.1 Terminal ID#1, ID#2, ID#3

Up to three terminal identifiers can be entered on the Device setup screen. When the Terminal ID text box is selected, the softkeys become alpha keys. Use the alpha keys to enter up to three terminal IDs. Press the ENTER key to accept the ID entered. These ID fields display in the information recall when the SYSTEM INFORMATION softkey  is pressed after the RECALL softkey . These IDs are also included in the Service Information Recall report and Terminal Status Report.



#### 3.8.1.2 Serial Number

The Serial Number text box is used to enter the serial number of the IND500x terminal.







The terminal serial number displays in the information recall when the SYSTEM INFORMATION softkey  is pressed after the RECALL softkey . The serial number is populated at the factory during manufacturing. The serial number is not cleared when a Master Reset is carried out on the terminal (See chapter [Master Reset ▶ Page 159], Service and Maintenance).

If the serial number requires re-entry (for example, if the main PCB is changed), use the alphanumeric keys to enter the terminal's serial number. The factory assigned serial number is located on the back of the terminal.



### 3.8.1.3 Connected Devices

The Connected Devices softkey provides access to a list where information on devices connected to the terminal can be stored/viewed. This list must be populated manually during the installation. Once populated, it can be viewed from this location within setup or with the Connected Devices softkey  which displays when the SYSTEM INFORMATION softkey  is pressed after the RECALL softkey  is pressed on the home screen. The fields for each connected device record include Description, Model and Note.

#### 3.8.1.3.1 To Add or Modify Connected Device Records

- 1 Press the Connected Devices softkey  at the bottom of the Device screen.
- 2 Press the NEW softkey  to create a new record.
- 3 To edit an existing record, press the UP and DOWN navigation keys to select (highlight) a record in the list then press the EDIT softkey  to open the Edit screen.
- 4 Press the UP and DOWN navigation keys to move the focus to the field name to be edited or inserted.
- 5 Press the ENTER key to select a field value to edit or insert.
- 6 Use the alphanumeric keypad to edit or enter the desired value.
- 7 Press the OK softkey  to accept the modifications or additions.
- 8 Press the ESCAPE softkey  to return to the Connected Devices screen without saving modifications or additions.
- 9 Press the EXIT softkey  to return to the Device screen.

#### 3.8.1.3.2 To Delete or Clear Connected Device Records

- 1 Press the UP and DOWN navigation keys to move the focus to the record to be deleted. Press the DELETE softkey  to delete this record from the list.
- 2 Press the CLEAR softkey  to clear all records from the list.
- 3 Press the EXIT softkey  to return to the Device screen.

## 3.8.2 Display

Use the Display setup screen to configure settings for Backlight Timeout, Tare Display, Auxiliary Display and Metrology Line. A backlight adjustment softkey  is also available on this page.

### 3.8.2.1 Backlight Timeout

The display backlight can be set to turn off after a specific period of terminal inactivity, set in minutes.

### 3.8.2.2 Tare Display

This setting determines whether the tare display is shown on the home screen when the largest size weight display is shown. The tare display is not available when Auxiliary Display is enabled.

Display options for the tare display include:

Disabled	The tare value will not be shown in the weight display
<b>Active</b> [default]	The tare value is shown on the largest weight display only when a tare has been taken. In the gross mode, no tare value is shown.
Always	There is a reserved space on the largest weight display for the current tare value. In the gross mode, the tare is shown as zero.

### 3.8.2.3 Auxiliary Display

A Rate or DI/O Status display can be displayed on the home screen in addition to the weight. The weight display changes size to accommodate the auxiliary display selection.

The choices for Auxiliary Display are: Disabled, DI/O Status, and Rate.

When Rate or DI/O Status is selected for the auxiliary display, the weight display is shown in half size and the auxiliary display is shown below the weight. The number of DI/O inputs and outputs shown will match the number of inputs and outputs of the internal I/O option installed in the terminal.

#### See also

[SmartTrac™](#) ▶ Page 54

### 3.8.2.4 Metrology Line

A metrology line that displays programmed capacity and increment information or Max/Min/e information can be enabled.

The selections are:

Disabled, **Cap/d** [default], Max/Min/e

This metrology line may serve to meet the metrological display requirements of various regions in the world. In case the metrology date line is not accepted by an agency, it can be disabled and a label with the required information may be installed near the display.

### 3.8.2.5 Backlight Adjustment

If an LCD-type display is detected, a Backlight Adjustment softkey  appears in position 3. Press this softkey to display the backlight adjustment screen.

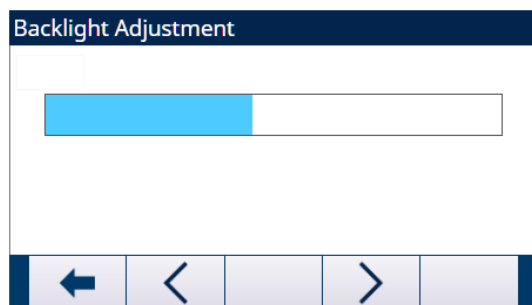

Figure 79: Backlight Adjustment Screen

User can press the Darker  and Brighter  softkeys to adjust the backlight.

## 3.8.3 Region

The Region setup screens enable configuration of the time and date, the language for messages, the gross weight symbol used on the display and whether a comma or decimal will be used in weight values transmitted or printed from the terminal.

### 3.8.3.1 Format Time & Date

Selection boxes on this setup screen enable formatting of the time and date and the date field separator character.

#### 3.8.3.1.1 Time Format

Selections are:

12:MM	12-hour clock with hour and minutes displayed
12:MM:SS	12-hour clock with hour, minutes, and seconds displayed
24:MM	24-hour clock with hour and minutes displayed
<b>24:MM:SS</b> [default]	24-hour clock with hour, minutes, and seconds displayed

#### 3.8.3.1.2 Date Format

Selections are:

DD/MM/YY	Two-digit day, month, year
<b>DD/MMM/YYYY</b> [default]	Two-digit day, three-character month, four-digit year

MM/DD/YY	Two-digit month, day, year
MMM/DD/YYYY	Three-character month, two-digit day, four-digit year
YY/MM/DD	Two-digit year, month, year
YYYY/MMM/DD	Four-digit year, three-character month, two-digit day

### 3.8.3.1.3 Date Field Separator

Choices include:

None, / (**slash**) [default], - (dash), . (period), (space)

### 3.8.3.2 Set Time & Date

Enter the hour, minutes, day, month, and year on this setup screen's text fields and selection boxes. The terminal automatically adjusts the date for a leap year, and a battery backup maintains the time and date settings in the event of a power outage.

When needed, the time must be manually adjusted for daylight savings time. The weighing terminal does not make this adjustment automatically.

#### 3.8.3.2.1 Hour

Enter the hour in the Hour field text box. If the time format is set to 12:MM or 12:MM:SS on the Format Time & Date setup screen, **AM** [default] or PM must be selected.

#### 3.8.3.2.2 Minutes

Enter the minutes in the Minutes field text box

#### 3.8.3.2.3 Day

Enter the day in the Day field text box.

#### 3.8.3.2.4 Month

Use the Month selection box to select the month.

#### 3.8.3.2.5 Year

Enter the year in the Year field text box.

### 3.8.3.3 Language

Use the Language setup screen to specify the language, gross weight legend and decimal/comma character for the terminal.

#### 3.8.3.3.1 Display Message

Use the Display Messages selection box to select the language for messages that display on the terminal.

Choices are:

**English** [default], French, German, Italian, Polish, Portuguese, Russian, Spanish, Chinese, Custom

#### 3.8.3.3.2 Keypad Selection

Use the Keypad Selection box to select the language for the keypad alpha characters that are available on the terminal.

Choices are:

**English** [default], Global, Russian

If Russian is selected, Cyrillic characters will be available via the softkeys. The global characters will continue to be available via the numeric keys.

### 3.8.3.3.3 Print Comma/Decimal

Use this parameter to indicate if a comma or decimal point will be used for weight values in demand data outputs.

Choices are:

Comma, **Decimal point** [default]

### 3.8.3.3.4 Gross Legend

This parameter determines what character or characters will be shown on the display to indicate a gross weight field. Typical characters are "G" for gross [default] or "B" for bruto/brutto. A maximum of three characters can be entered.

## 3.8.4 Transaction Counter

Use the Transaction Counter setup screens to configure transaction counter operations.

The transaction counter is a seven-digit register that tracks the total transactions that are completed on the terminal with a demand print output. When the value reaches 1,500,000, the next transaction causes a roll-over to 0000001. Access to this feature is granted through the setup menu or the Transaction Counter softkey **1|2|3** which can be added to the home page (refer to [Softkeys ▶ Page 115]). Use the Transaction Counter setup screen to configure transaction counter operations.

### 3.8.4.1 Transaction Counter

Use the Transaction Counter selection box to enable or disable the transaction counter.

Choices are: Disabled [default], Enabled

### 3.8.4.2 Counter Reset

This step is shown only if the Transaction Counter has been enabled. Use the Counter Reset selection box to permit manual reset of the counter or manual entry of a starting number.

Choices are:

**Disabled** [default], Enabled

### 3.8.4.3 Next Transaction

The value for the counter for the next transaction displays in the Next Transaction field. If Counter Reset is enabled, a value between 1 and 1,500,000 can be manually entered here. The counter can also be reset to 0000001 by pressing the RESET softkey **↺** on this page or from the home page through the Transaction Counter.

## 3.8.5 Users

Security access to the weighing terminal is divided into three user groups: **Operator, Supervisor and Administrator**. By default, the weighing terminal is pre-configured with two usernames: "Admin" and "Operator". The Admin cannot be deleted or renamed, while the Operator can be deleted or renamed on the setup. The default user is Operator.



As soon as a password is entered on the default "Admin" username, user security is enabled in the terminal and a login will be required before changes can be made in setup and before certain softkey functions can be executed. Up to a maximum of 20 users can be stored in the terminal. A minimum of one and a maximum of 12 characters can be entered for both the Username and the Password. Refer to [User Security ▶ Page 21] and [Default Settings ▶ Page 194] for additional information on user security.

### 3.8.5.1 To Enter A New Username and Password

- 1 Press the ADD softkey **+** to access the User Edit screen.
- 2 Enter the desired username in the Username field.
- 3 Use the Access selection box to assign the appropriate access level to the user. The following access levels are available:

Administrator	An Administrator level has access to all setup parameters.
Supervisor	Next lower level of access.





Operator                      Lowest level of access.

- 4 Enter the desired password in the Password and Confirm Password fields.
- 5 Press the OK softkey  to accept the username and password as entered.
- 6 Press the EXIT softkey  to exit without saving the username and password.

**Note:**

- Passwords are case-sensitive.
- All numbers and all characters available in the alphanumeric keys are valid for use in passwords.
- Be sure to store a record of user passwords in a safe place. Without a correct password for an administrator level account, full access to the setup menu will not be possible.

### 3.8.5.2 To Modify and/or Enter A Password for A Username

- 1 Move focus to the username to be edited.
- 2 Press the EDIT softkey  to access the User Edit screen.
- 3 Press the DOWN navigation key  to view the second screen, which displays the Password and Confirm Password fields.
- 4 Enter the desired password in the Password and Confirm Password fields.
- 5 Press the OK softkey  to accept the password as entered.
- 6 Press the EXIT softkey  to exit without saving the password.

### 3.8.5.3 Delete A User or Clear All Users

Press the DELETE softkey  to delete a username from the table on the Users screen. **Username "Admin" and "Operator" cannot be deleted.**

### 3.8.6 Auto Logout

Auto Logout is used for logout of active administrator or supervisor user. In this way, user will not always stay in active non-default administrator, or supervisor user state.

- 1 Press the SETUP softkey  in the Home Page.
- 2 To find the Auto Logout branch, follow the path: Setup>Terminal>**Auto Logout**.
- 3 In the **Auto Logout** page, select to Enable or Disable the **Auto Logout** function.

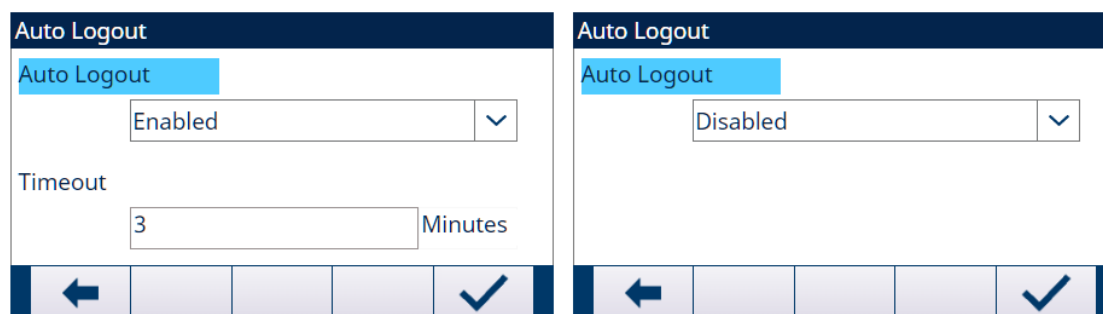



Figure 80: Auto Logout

- ➔ **Enabled:** The time is remembered while login and terminal checks if timeout is expired periodically. If timeout is expired, the active user will logout and default user will login.
  - ➔ **Disabled:** No timeout is set for logout. The active user must log out manually. See [Logout ▶ Page 60]
- 4 If Auto Logout function is Enabled, enter the **Timeout** value (1 – 1440min). The default value of **Timeout** is 5 minutes. See chapter 7.3 [Default Settings ▶ Page 194].

### 3.8.7 Softkeys

Add or rearrange the display of softkeys on the main weighing screen by configuring parameters on the softkey setup screen.

Adding a softkey to the home pages of the terminal does not automatically enable the softkey function. Most functions associated with softkeys must also be enabled in setup. For instance, adding the UNITS SWITCHING softkey  does not automatically enable units switching – a second or third unit must also be enabled in the Scale branch of setup. If a softkey has been added in setup but does not appear on the home page, check that the setup parameters for that function have been enabled.

**Note:** If an entire row of softkeys is blank, then that row will not be made available at the home screen. For example, if softkey positions 1–5 have softkeys programmed and positions 11–15 have softkeys programmed but softkey positions 6–10 are blank, the second row of softkeys will not be shown from the home screen.

The following softkeys are available for assignment to the home page. For a comprehensive list of all available softkey icons with descriptions, refer to [Operation ▶ Page 21].

None	Recall Info *	Task 2 **
Alibi	Repeat Print	Task 3 **
Backlight Adjustment	Reports	Task List **
Calibration Test	Setup *	Time & Date
Comparators	Unit Switching	Totalization
Login	Tare Table	Transaction Counter
ID 1	MinWeigh	Trigger 1
ID 2	Event Alert Recall	Trigger 2
ID 3	x10 Display	Trigger 3
ID 4	Task 1 **	

\* Cannot not be removed from home screen.

\*\* Only available when TaskExpert™ is installed.

### 3.8.7.1 Editing Softkeys

When the softkeys setup screen opens, focus is on the softkey position number “1” located above the first icon (see figure below).

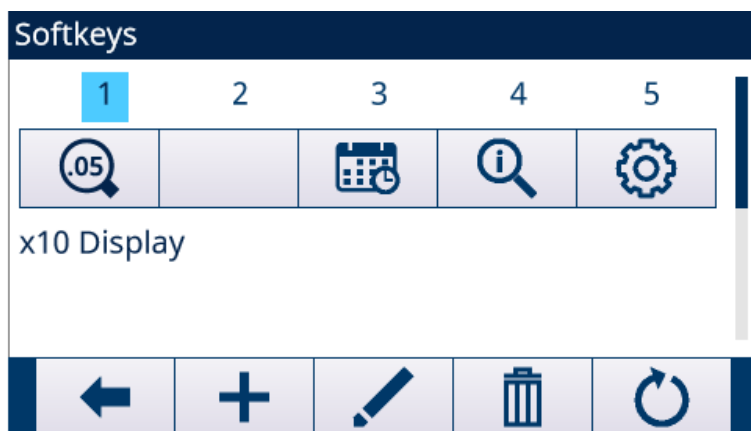





Figure 81: Softkey Setup

The focus can be moved by pressing the UP, DOWN, LEFT, and RIGHT navigation keys. As a different softkey position gains the focus, its assignment is shown in text toward the bottom of the screen.

For example, in the figure above focus is on softkey position number 1, which is assigned the UNIT SWITCHING softkey . Press the RIGHT navigation key twice to move focus to softkey position 3. The assignment value changes to the REPORTS softkey .

Two softkeys, INFORMATION RECALL  and SETUP , must always be present. As a default, they are located together in positions 9 and 10. These keys can be moved by first creating a copy of the softkey in a new position and then deleting the softkey from the original position. The original assignment cannot be removed until the new position has been created.





Press the UP, DOWN, LEFT and RIGHT navigation keys to navigate among the softkey position numbers until the required softkey number is in focus. Softkeys can be added, removed, and positioned using the softkeys:



**Edit**

Changes the softkey in the selected position to another softkey or to none, which leaves the softkey position blank. Editing a blank position does not move the position of following softkeys







	<b>Add</b>	Inserts a softkey into a selected position. All other softkeys located at or after that position increase position number by one.
	<b>Delete</b>	Deletes a softkey in a selected position. All other softkeys located at or after that position decrease position number by one.
	<b>Reset</b>	Clears all softkey assignments except INFORMATION RECALL  and SETUP  softkeys. These will be shown in positions 1 and 2 respectively.

### 3.8.7.1.1 Inserting Softkeys

**Note:** When a softkey is inserted, all softkeys in positions after the selection insertion point will be shifted one space to the right.

#### To insert a softkey



- 1 Use the navigation keys to move the focus to the position number where the softkey is to be inserted.
- 2 Press the ADD softkey . The Softkey Edit screen displays. The softkey position selected is shown on the screen along with Assignment selection box.
- 3 Press the ENTER key to select the assignment selection box.
- 4 Use the UP or DOWN navigation keys to scroll through the selections until focus is on the desired assignment.
- 5 Press the ENTER key to select the assignment. If None is selected for the assignment, the softkey assignment is reserved as a blank space.
 

**Note:** If all 15 softkey positions are full and a new softkey is added, all positions after the inserted position will move one position to the right and the softkey in position 15 will be lost. The only exception to this is if the RECALL  or SETUP  softkeys are in position 15, the softkey immediately before these special softkeys will be lost.
- 6 Press the EXIT softkey  to return to the Softkeys Setup Screen. The new softkey will display on the Softkey setup screen in the position where it was inserted and all following softkeys will be moved one position to the right

### 3.8.7.1.2 Editing Softkeys

The edit function allows one softkey assignment to be replaced with another. Use this function to replace a blank assignment with another softkey assignment, without moving any other softkey positions.

#### To edit a softkey

- 1 Use the navigation keys to move the focus to the position number of the softkey to be edited.
- 2 Press the EDIT softkey . The Softkey Edit screen shows. The softkey position number selected for editing is shown on the screen, together with the softkey's current assignment – or **None**, if no softkey is assigned.
- 3 Press the ENTER key to select the assignment selection box.
- 4 Use the UP or DOWN navigation keys to scroll through the selections until focus is on the desired assignment.
- 5 Press the ENTER key to select the assignment. If None is selected for the assignment, the softkey assignment is reserved as a blank space
- 6 Press the EXIT softkey  to return to the Softkeys Setup Screen.

**Note:** There is no limit on the number of positions that can have the same softkey assignment. For example, a softkey can be assigned to a position in each of the three available rows, so that it is always visible and available for use.

### 3.8.7.1.3 Deleting Softkeys





**Note:** When a softkey assignment is deleted, all softkeys to the right of the deleted key will move one position to their left.

#### To delete a softkey

- 1 Use the navigation keys to move the focus to the position number of the softkey to be deleted.
- 2 Press the DELETE softkey . The softkey will disappear from the Softkey setup screen, and all following softkeys will be moved one position to the left.



**Remember that there must always be one instance each of the RECALL and SETUP softkeys. The original softkey cannot be deleted until a new position has been created.**

### 3.8.7.1.4 Clearing All Softkeys

To clear all softkey assignments except INFORMATION RECALL  and SETUP , press the CLEAR softkey . A screen will display requesting confirmation of the action. Press the OK softkey  to continue, or the EXIT softkey  to return to the Softkeys setup screen.

### 3.8.8 Reset

The Reset setup screen resets setup values to factory default settings for the Terminal branch of setup.

- 1 To initiate a Reset, press the OK softkey .
  - ➔ If the Reset is successful, the verification message "Reset Successful" shows.
  - ➔ If the Reset is not successful, the error message "Reset Failure" shows.
- 2 If the Reset fails, try to initiate the Reset again.
- 3 If the Reset continues to fail, contact a local METTLER TOLEDO representative for assistance.
- 4 Press the EXIT softkey  to exit without resetting.

## 3.9 Communication

The configuration screens for the Communication branch of setup are shown below.

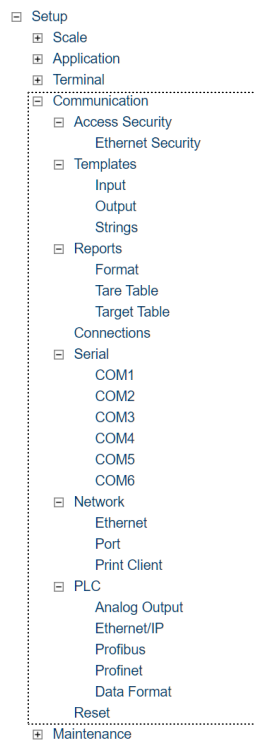

Figure 82: Setup Tree

### 3.9.1 Security

By default, access to the IND500x through the Ethernet is limited. Selections made in the Access/Security parameters determine the level of access to files and data that will be allowed.

#### 3.9.1.1 Ethernet Security

Access to the terminal Shared Data Server, Web Server and FTP function are selected at this branch of setup.

##### Shared Data Server

This setting determines access to the Shared Data Server over an Ethernet connection.

### **Options**

- Read/Write [default]
- Read Only
- Disabled

### **Web Server**

Web Server access must be set equal with or below the access level selected for the Shared Data Server.

### **Options**

- Disabled [default]
- Read/Write
- Read Only

### **FTP (File Transfer Protocol)**

#### **Options**

- Read/Write [default]
- Read Only
- Disabled

### **TLS (Transport Layer Security)**

#### **Options**

- Enabled [default]
- Disabled

When TLS is enabled, a secure connection is set between a client and a server, typically over the Internet using TCP/IP. Https, an encrypted version of HTTP, is applied in Web Server. FTPS (File Transfer Protocol Secure) is applied in File Transfer.

## **3.9.2 Templates**

The input template function allows the IND500x to receive a string input (such as from a bar code scanner) and use it as data entry for a TaskExpert application, an ID data collection field, preset Tare weight, or selection of a stored Tare ID or Target ID. When the IND500x Fill Pac Application Software is installed, the input template can also be used for selection of the target for Weigh-in or Weigh-out.

The IND500x terminal supports ten output templates (1,000 bytes in size) that can be used to define the format of on demand or continuous data outputs.

The template Strings setup supports creation and storage of character strings that are frequently used in templates. Creating and storing frequently used character strings decreases the time it takes to create output templates through the terminal HMI.

### **3.9.2.1 Input**

The Input Template can be used to strip unnecessary characters from an incoming string of data and identify only the specific data needed for a function.

#### **Note**

The setup parameters for Input Template are explained in this section.

#### **Preamble Length**

This parameter defines how many characters are skipped at the beginning of an input string before the desired data is identified. Values from 0 to 255 can be entered.

#### **Data Length**

This parameter defines the length of the data to be extracted from the incoming string. All characters beginning after the preamble through the data length selection are used as the input. Values from 1 to 40 are accepted.

#### **Postamble Length**

This parameter defines the number of characters (before but not including the termination character) that will be stripped off the end of the incoming data string. When using an input that is always the same fixed length, this field remains blank. Values from 0 to 255 are accepted.

All characters after the preamble length to the termination character minus the postamble length are used as the input data string.

### Termination Character

This parameter is used to signal the end of the string input. The termination character can be any ASCII control character.

Selections for Termination Character include:

None	EOT	BS	FF	DLE	DC4	CAN	FS
SOH	ENQ	HT	<b>CR</b>	DC1	NAK	EM	GS
STX	ACK	LF	SO	DC2	SYN	SUB	RS
ETX	BEL	VT	SI	DC3	ETB	ESC	US

### Assignment

This parameter determines how the input data should be used. Selections include:

Application	Data is available in Shared Data for use by a custom TaskExpert program.
ID Response1	Input populates the first response to the ID1 sequence.
Keypad	Data that would normally be entered using the alphanumeric keypad may be scanned in with this setting.
Tare	Enters data as a preset tare value. If the data string does not include the unit characters, preset tare value with the current unit.
Tare ID	Uses incoming value as an ID lookup in the tare table.
Target ID	Uses incoming value as an ID lookup in the target table.

## 3.9.2.2 Output

The Output Template setup screen enables configuration of the output data formats and the location of the "Duplicate" text for the Repeat Print function.

### Template



The Template to be viewed, modified, copied or cleared can be selected in this field. **Template 1** to Template 10 are available for user selection.

### Repeat Print Field



This field determines if the "DUPLICATE" designation is added to a repeat print of an output template. Selections include:

Disabled	The text "DUPLICATE" will not be added to a repeat print.
Footer	The text "DUPLICATE" is added as a new last line in the template format for a repeat print.
Header	The text "DUPLICATE" is added as a new first line in the template format for a repeat print.

### 3.9.2.2.1 Copy A Template

- The **Output Template** page shows.
  - 1 To copy one template as the beginning point for another template, press the COPY softkey .
  - 2 Select the template to be copied from and the template to be copied to in the new page shown.
  - 3 Press the OK softkey  to perform the copy.
  - 4 Press the EXIT softkey  to exit without making a copy.

### 3.9.2.2.2 Clear A Template

- The **Output Template** page shows.
  - 1 Select the Template to be cleared in the field **Template**.
  - 2 Press the CLEAR softkey  to clear all elements from the selected Template.
    - ➔ A warning page shows as a precaution.
  - 3 Press the OK softkey  to clear or press the EXIT softkey  to exit without making any changes.

### 3.9.2.2.3 View, Edit or Add A Template

#### Viewing

- The **Output Template** page shows.
- Press the VIEW TABLE softkey  to access the selected Template’s view page.
  - ➔ The view page lists each element configured for the Template and includes action softkeys. Each element is defined by the data type, actual data, justification and length. Elements can be edited, added (inserted), or deleted individually.

#### Editing

- 1 Press the UP and DOWN navigation keys to select an entry to edit.
- 2 Press the EDIT softkey  to open the setup screen for the record where edits can be made. The element number cannot be edited.
- 3 Select the element type from the Type selection box. Four element types are available:
  - CR/LF Combination carriage return and line feed used to terminate a line.
  - SDName Shared Data Variable Name from the terminal that includes data for the Template
  - Special Character Insert a control character into the template.
  - String A string of characters to print
- 4 Press ENTER to confirm the element type selection.
  - ➔ Additional configuration options show for different element type selected. See [Template Editing Options ▶ Page 121]

#### Adding

- 1 Press the UP and DOWN navigation keys to select a location in the list of elements to insert a new Template element.
- 2 Press the ADD softkey  to open the setup page to create a new record.
- 3 Configure the parameters. All following elements are moved down one position. See [Template Editing Options ▶ Page 121]

#### Deleting

- 1 Press the UP and DOWN navigation keys to select an element to delete.
- 2 Press the DELETE softkey  to delete the element.

#### Test Printing

- Press the EXPORT softkey  to perform a test print of the Template being configured.

#### Template Editing Options

The editable fields that appear for each Element Type and Format selection are shown in the table that follows.

Template Element Editing Options					
Element Type	Data	Repeat Count	Format	Length	Leading Zero Fill
CR/LF	-	Blank**	-	-	-
SDNAME	Blank*	-	Default	-	-
			Centered, Left	Blank**	-
			Right	Blank**	Enabled/Disabled
Special Character	ASCII character list	-	-	-	-
String	Blank**	Blank**	Default	-	-
			Center, Left, Right	Blank**	-
- Fields not available					
* Alphanumeric entry field					
** Numeric entry field					

#### Repeat Count

A numeric value that sets the number of times the Data will repeat. For example, if the string data entered is an asterisk (\*), a repeat count value of 20 would produce a row of 20 asterisks: \*\*\*\*\*.

## Format & Length

The Format & Length options are Default, Centered, Left, and Right. These describe the justification of the data within the length of the field.

The Default value is fixed, and Length cannot be defined here.

For SD name and String data, the Centered, Left and Right formats are accompanied by a Length field. After choosing the format, focus moves to the Length entry box. This value determines how long the element will be – the data will be positioned within a string of the length entered.

### Notes:

If data for an element includes more characters than the value entered for Length, the output data will be cut off. For example, if the number of characters entered under format on the Output Template Edit Screen is six, and data for a string that contains eight characters is entered, only six of the characters from the data string will print. If data for a string that contains four characters is entered, all of the characters from the data string will print.

The characters and alignment of the printed data are defined by the selected format:

- Example: 8-character string of ABCDEFGH in a 6-character element

### Centered

B	C	D	E	F	G
---	---	---	---	---	---

### Left

A	B	C	D	E	F
---	---	---	---	---	---

### Right

C	D	E	F	G	H
---	---	---	---	---	---

Figure 83: Example

Centered: Prints the middle 6 characters from an 8-character string – drops first and last characters.

Left: Prints the first 6 characters from an 8-character string – drops the last 2 characters.

Right: Prints the last six characters from an eight-character string – drops the first 2 characters.

- Example: 4-character string of ABCD in a 6-character element

### Centered

	A	B	C	D	
--	---	---	---	---	--

### Left

A	B	C	D		
---	---	---	---	--	--

### Right

		A	B	C	D
--	--	---	---	---	---

Figure 84: Example

Centered: Prints all 4 characters from a 4-character string in a centered position, leaving a space at the beginning and a space at the end.

Left: Prints all 4 characters from a 4-character string in a left-justified position, leaving 2 spaces at the end.

Right: Prints all 4 characters from a 4-character string in a right-justified position, leaving 2 spaces at the beginning.

## Example of Shared Data Names for Use in Templates

Dashes in the SDName (e.g. sd--08) means that there are more than one instance of the share data variable. The instance number appears in place of the dashes (e.g. sd0308, for the third comparator's target comparison operator).

For a full list of Shared Data fields, please refer to the IND500x ShareData Manual (Doc. No.: 30753836) on CD.

IND500x Data Field	SDName	Length (A/N = alphanumeric)
<b>Terminals</b>		
Scale ID	cs0103	20 A/N
Base Serial Number	ce0138	13 A/N
Terminal Serial Number	xs0105	13 A/N

IND500x Data Field	SDName	Length (A/N = alphanumeric)
Terminal ID#1	xs0106	20 A/N
Terminal ID#2	xs0107	20 A/N
Terminal ID#3	xs0108	160 A/N
Current Date	xd0103	11 A/N
Current Time	xd0104	11 A/N
Transaction Counter Value	xp0101	9 A/N
Grand Total Value	tz0101	12 A/N
Grand Total Count	tz0102	9 A/N
Subtotal Value	tz0103	12 A/N
Subtotal Count	tz0104	9 A/N
ID1 Prompts 1-30	pr0131-pr0160	30 A/N
ID1 Prompt Responses 1-30	pa0101-pa0130	51 A/N
ID2 Prompts 1-30	pr0231-pr0260	30 A/N
ID2 Prompt Responses 1-30	pa0201-pa0230	51 A/N
ID3 Prompts 1-30	pr0331-pr0360	30 A/N
ID3 Prompt Responses 1-30	pa0301-pa0330	51 A/N
ID4 Prompts 1-30	pr0431-pr0460	30 A/N
ID4 Prompt Responses 1-30	pa0401-pa0430	51 A/N
Message 01, 02, etc.	aw0101, 0102,...	100 A/N
Templates 1 – 10*	pt0101 – pt0110	As programmed
Template Strings 1–20	pt0111 – pt0130	51 A/N
<b>Targets</b>		
Target Description	sp0101	20 A/N
Target Value	sp0105	12 A/N
Target Units	sp0120	3 A/N
Fine Feed	sp0110	12 A/N
Spill Value	sp0109	12 A/N
+ Tolerance Value (weight)	sp0111	12 A/N
– Tolerance Value (weight)	sp0112	12 A/N
+ Tolerance Value (%)	sp0114	12 A/N
– Tolerance Value (%)	sp0115	12 A/N
Comparator names 1-5	sd--01	21 A/N
Comparator target coincidence values 1 - 5	sd--05	12 A/N
Comparator target comparison operators 1-5	sd--08	5 A/N
Comparator second weight range values 1-5	sd--09	12 A/N
Comparator second weight range comparison operators 1-5	sd--10	5 A/N
<b>Weights</b>		
Scale Mode (Gross/Net)	ws0101	1 A/N (G or N)
Tare Source Description	ws0109	2 A/N "T<space>", or "PT"
Displayed Tare Wt.	ws0110	12 A/N
Displayed Gross Wt.	wf0101	12 A/N
Displayed Net Wt.	wf0102	12 A/N
Displayed Wt. Units	wf0103	3 A/N

IND500x Data Field	SDName	Length (A/N = alphanumeric)
3rd Weight Unit Gross Weight	wf0104	13 A/N
3rd Weight Unit Net Weight	wf0105	13 A/N
3rd Units	wf0106	3 A/N
Displayed Rate	wf0108	13 A/N
Rate Time Units	cs0107	1 A/N
Rate Weight Units	cs0108	1 A/N
Custom Unit Name	cs0112	12 A/N
Custom Unit Conversion Factor	cs0113	12 A/N
Calculated Weight**	ws0132	1 A/N

\* Using a template field code within another template will insert the entire template into the new template.

\*\* Used in multi-interval scales to indicate that the gross weight is calculated, and mathematically incorrect. In a multi-interval scale, the resolution of increments differs for each interval – for example, 0 – 5 kg, 0.0005, >5 kg, 0.001; thus, the sum of the tare and net weights will not precisely equal the gross weight. The ws0132 variable should be added to the template, and appears as a letter “C” after the weight unit – e.g. “5.304 kg C”.

### Printing Multiple Weight Units

If a third weight unit is defined, it can be named in a template so that it appears in the output data together with the displayed unit. However, if the third unit is currently displayed on the terminal, it will appear twice in the data output. Therefore, if the output is to include both primary and 3rd weight units, ensure that the primary unit data is displayed when the data output is initiated.

#### Note

Secondary Units are not available for multiple unit printing.

### 3.9.2.3 Strings

This setup page defines strings of characters that are frequently used in template messages. Template strings can be viewed, edited, inserted, deleted, or printed.

#### Viewing

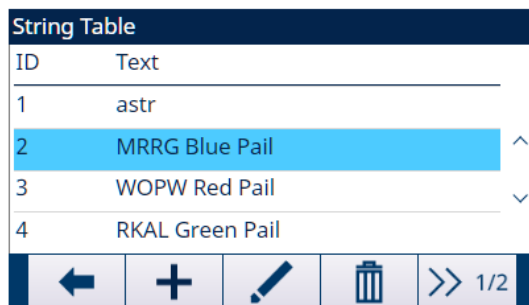

- 1 Press the VIEW TABLE softkey . The String Table page shows.



ID	Text
1	astr
2	MRRG Blue Pail
3	WOPW Red Pail
4	RKAL Green Pail

Navigation icons: Back, Add, Edit, Delete, Next (1/2)



Figure 85: String Table

- 2 Press the NEXT softkey .
- 3 Press the FILTER OFF softkey .
- 4 Use the Search Field selection box to select ID or String and enter information in the Data field to limit the search, or do not enter any search limits to view all template strings.
- 5 Press the OK softkey  to show the search results.
  - ➔ Only records with non-null values display. Records are ordered by ID, with the lowest ID number shown first.
- 6 Press the UP and DOWN navigation keys to scroll up and down the screen in order to view all strings listed.





## Editing

Not all keyboard characters are available when entering information using the IND500x keypad. However, characters such as the “|” (pipe) can be included in a template created using the InSite™ CSL software. They will be recognized by the IND500x when the template is downloaded, will display correctly, and will be included in the template when it is printed.

- 1 Press the UP and DOWN navigation keys to select (highlight) the string record to be edited.
- 2 Press the EDIT soffkey  to open the record for editing. The edit screen will be shown with focus on the “Text” label. This is the only editable field on the screen. The ID number cannot be changed.
- 3 Press ENTER to access the text field.
- 4 Use the alphanumeric keypad to edit the string. A string can be a maximum of 50 characters.
- 5 Press ENTER when complete.
- 6 Press the OK soffkey  to accept the edited record and return to the String Search View screen.
- 7 Press the EXIT soffkey  to return to the String Search View screen without accepting the changes to the string.

## Adding

- 1 Press the ADD soffkey  to create a new record. An edit screen shows with “ID” and “Text” labels.
- 2 Press the UP and DOWN navigation keys to select the field to enter.
- 3 Press ENTER to access the field. When entering the ID field, the value shown is the first unused ID.
- 4 Use the numeric keypad to enter an ID number from 1 to 20.
- 5 Press ENTER when complete. If the ID entered already exists, an error display shows. The error must be acknowledged and a new ID must be entered.
- 6 If the TEXT field is entered, use the alphanumeric keypad to edit the text string.
- 7 Press ENTER when complete.
- 8 Press the OK soffkey  to accept the new record and return to the String Search View screen.
- 9 Press the EXIT soffkey  to return to the String Search View screen without accepting the new record.

## Deleting

- Press the DELETE soffkey  to delete a template string from the list.

## Printing

- Press the TRANSFER soffkey  to print the list.

### 3.9.3 Reports

The Reports setup pages enable configuration of the structure of Tare and Target Table reports that are generated by the IND500x terminal.

#### 3.9.3.1 Format

##### Format

In the Format field, user can use the selection box to select the width of all the Tare and Target table reports.

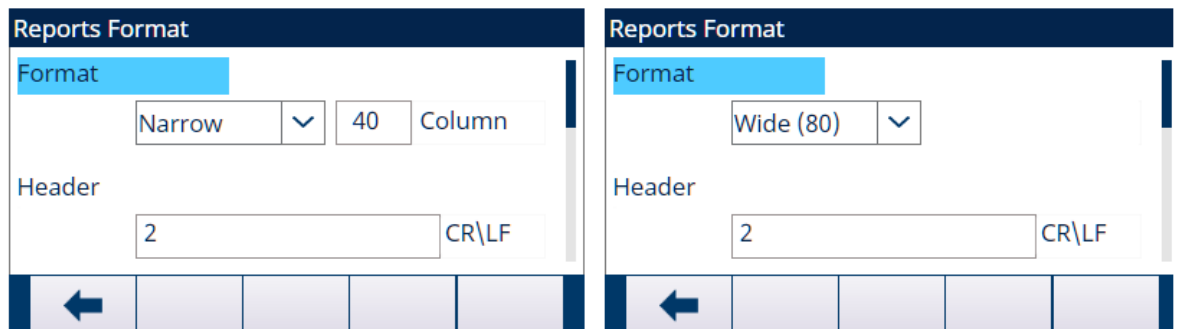

The figure shows two side-by-side screenshots of the 'Reports Format' screen. Both screens have a dark blue header with the title 'Reports Format'. The left screen shows the 'Format' dropdown menu set to 'Narrow', with a value of '40' and the label 'Column'. The 'Header' field contains the text '2' and 'CR\LF'. The right screen shows the 'Format' dropdown menu set to 'Wide (80)', with a value of '80'. The 'Header' field also contains '2' and 'CR\LF'. Both screens have a navigation bar at the bottom with a back arrow and several other buttons.

Figure 86: Reports Format

The selections include:

- Narrow [default]  
Column value can be customized from 10 to 99, and the default value is 40.

40 character-wide reports

- Wide (80)

80 character-wide reports

**Header**

The Header field specifies the number of blank lines (CR/LF) to be placed at the start of each report. Values from 0 to 99 are accepted with 2 as the default value.

**Title**

The Title selection box enables a default title line to be printed at the top of the report.

The selections include:

- Enabled [default]
- Disabled

**Record Separator**

A repeated character may be selected as a separator between printed records in the report. In this field, the character to be used is selected.

The selections include:

None [default]      \* (asterisks)      - (dashes)      = (equals)      CR/FL (blank line)

**Example**

If \* (asterisks) is selected, the line separator shows as follows:

\*\*\*\*\*

**Footer**

The Footer field specifies the number of blank lines (CR/LF) to be placed at the end of each report.

Values from 1 to 99 are accepted with a default value of 5.

**3.9.3.2 Tare Table**

This setup page is used to select which fields in the Tare Table show in a Tare Table Report print. The fields Low Limit, Upper Limit, and ID are always printed, and can't be disabled.

Field	Options	Description
Tare	Disabled	Selects if the tare value is printed or not in the report.
	Enabled [default]	
Description	Disabled [default]	Selects if the description is printed or not in the report.
	Enabled	
n	Disabled [default]	Selects if the totalization counter is printed or not in the report.
	Enabled	
Total	Disabled [default]	Selects if the total for each tare ID is printed or not in the report.
	Enabled	

**3.9.3.3 Target Table**

This setup page, which is only available when entered via AppEntry, is used to select which fields in the Target Table shows in a Target Table Report print.

- Fields that show and can be enabled or disabled vary depending on how the Target Table is configured in specific applications.
- The ID field is always printed, and can't be disabled.

### 3.9.4 Connections

The IND500x comes standard with single, intrinsically safe serial port COM1 and COM6 (optional). Additional ports are available by:

- Installing the current loop or fiber optic interface and using COM4 and/or COM5 to communicate with an ACM500 safe area communication module. When using the ACM500 module with the Ethernet/COM2/COM3 option installed, serial ports COM2 and COM3 and Ethernet connections Eprint1, Eprint2, Eprint3, Eprint4 and Print Client become available.  
**NOTE:** Always power up the ACM500 before turning on the power to the IND500x. This will ensure that the IND500x communicates correctly with the ACM500 and recognizes all installed options.
- Installing the intrinsically safe current loop interface option into the IND500x and using COM4 and/or COM5 directly. In this application, the COM4 and COM5 ports can be used to communicate with the ACM200 safe area communication module.
- Installing the fiber optic interface option into the IND500x and using COM4 and/or COM5 directly. In this application, the COM4 and COM5 ports can be used to communicate with the legacy dual channel fiber optic converter A100.

#### 3.9.4.1 COM4 and COM5

The COM4 and COM5 communication ports can be used as standard serial ports directly or can be dedicated to communicate with the ACM500 module. For connections to the IND500x, user must first decide how these two ports will be used.

The COM4 / COM5 Connection page is visible in setup even if no interface board is installed into the IND500x. If no interface board is installed, the assignments for COM4 and COM5 must be "Disabled".

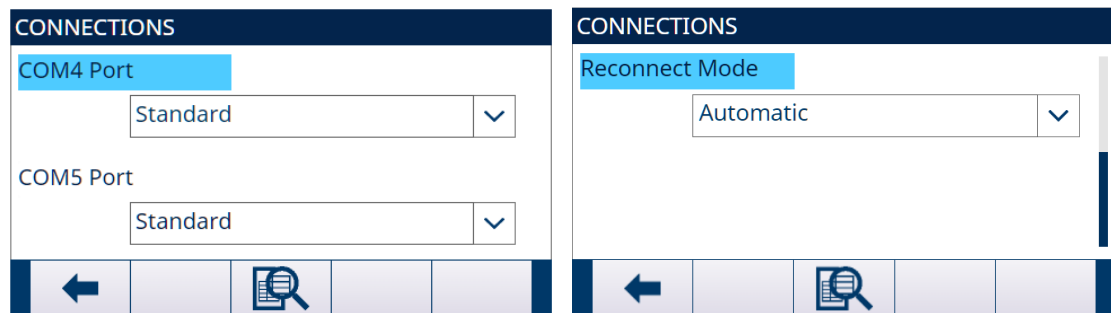

Figure 87: Connections

#### Edit the COM4 or COM5 Connection

- 1 Press the UP and DOWN navigation keys to select (highlight) the appropriate port, COM4 or COM5.
- 2 Press the ENTER key to edit the desired port.
- 3 Use the UP and DOWN keys to choose a connection type from the selection box.
- 4 Press the ENTER key to accept and save the connection parameter.

Available COM4 / COM5 Port Connections		
Port	Connection	Function
COM4	Disabled	Port will not be used.
	Standard	Port will be used directly with ACM200, Fiber Optic converter or IND256x.
	ACM500	Port will be used to communicate with ACM500 for COM2, COM3 or PLC connectivity.
COM5	Disabled	Port will not be used.
	Standard	Port will be used directly with ACM200, Fiber Optic converter or a remote IND256x.
	ACM500	Port will be used to communicate with ACM500 for Ethernet TCP/IP connectivity.

The table that follows provides an overview of what the COM4 and COM5 settings should be for the various peripheral communication devices that work with the IND500x.

COM4 / COM5 Setup for Various Communication Modules		
Peripheral Communication Device	Correct COM Connection	Application Notes
None	Disabled	No communication intended over COM4/COM5
ACM200 Module (Communication available over current loop interface only)	COM4 = Standard and/or COM5 = Standard	The ACM200 provides a single RS-232 port in the safe area. Two ACM200 modules can be supported simultaneously, one each on COM4 and COM5.
Legacy Fiber Optic Converter 64007275	COM4 = Standard and/or COM5 = Standard  *1 or 2 communication channels may be required. Dependant on legacy setup.	The FO converter supports one or two channels of RS-232 or 20mA communication in the safe area. This selection would be used when replacing a Puma, ID3sTx, 8141 or 8525 terminal that is communicating to a fiber optic converter.
IND256x (Communication available over current loop interface only)	COM4 = Standard and/or COM5 = Standard	The IND256x with Interface-Remote installed can be used as a remote display inside the hazardous area. Only one of the two available ports is required for this functionality.
ACM500	COM4 = ACM500 and/or COM5 = ACM500  *Only 1 channel required in some cases.	The ACM500 can provide PLC and COM2/COM3/Ethernet communications in the safe area.

### 3.9.4.2 Reconnect Mode

The communication protocol between the IND500x and the ACM500 requires that the ACM500 is powered up first. If the ACM500 experiences a power cycle, the message "ACM500 COM Error" shows. IND500x provides the user with two options to re-establish communication automatically in the event of an ACM500 power loss.

– Select the **Reconnect Mode** as **Manual** or **Automatic**

- ➔ **Manual:** IND500x will pop up a message box to let user confirm "ACM500 COM Error" and then reboot as soon as IND500x is informed.
- ➔ **Automatic:** IND500x will automatically reboot as soon as IND500x is informed.

### 3.9.4.3 Communication Port Assignment

The Connections View setup screen defines what type of communication will occur over each port. If no connections are programmed, nothing will be available on the COM ports or Ethernet ports.

Ports available for assignment can include the standard serial port COM1, optional COM2, COM3, COM4, COM5 and COM6 serial ports, the optional Eprint ports, and the print client port.

The availability of optional port COM6 depends on the whether the optional board is mounted on the mainboard.

The availability of COM2, COM3, COM4 and COM5 optional ports depends on the selections for COM4/COM5 on the Connections page as well as optional interfaces installed in the ACM500.





Various COM4/COM5 setup combinations exist.

The table that follows shows the ports available for additional assignment based on the initial setup selections for COM4 and COM5.

COM4=Standard/COM5=Standard/Optional COM6 Installed	
Available Port	COM1, COM4, COM5, COM6

Ports Not Available	COM2,COM3,Eprint 1,2,3,4, Print Client
COM4=Standard/COM5=ACM500/Optional COM6 Installed	
Available Port	COM1,COM4, COM6, Eprint 1,2,3,4, Print Client
Ports Not Available	COM2, .COM3,COM5
COM4=ACM500/COM5=Standard/Optional COM6 Installed	
Available Port	COM1,COM2,COM3,COM5,COM6
Ports Not Available	Eprint 1,2,3,4, Print Client
COM4=ACM500/COM5=ACM500/Optional COM6 Installed	
Available Port	COM1,COM2,COM3,COM6,Eprint1,2,3,4,Print Client
Ports Not Available	COM4,COM5
COM4=Standard/COM5=Standard/Optional COM6 Uninstalled	
Available Port	COM1,COM4.COM5
Ports Not Available	COM2,COM3,COM6,Eprint1,2,3,4,Print Client
COM4=Standard/COM5=ACM500/Optional COM6 Uninstalled	
Available Port	COM1,COM4, Eprint 1,2,3,4, Print Client
Ports Not Available	COM2, .COM3,COM5,COM6
COM4=ACM500/COM5=Standard/Optional COM6 Uninstalled	
Available Port	COM1,COM2,COM3,COM5
Ports Not Available	COM4,COM6, Eprint 1,2,3,4, Print Client
COM4=ACM500/COM5=ACM500/Optional COM6 Uninstalled	
Available Port	COM1,COM2,COM3, Eprint 1,2,3,4, Print Client
Ports Not Available	COM4,COM5,COM6



### 3.9.4.4 Edit and Create Connection Assignments

- 1 Press the ADD softkey  to create a new connection assignment.
- 2 Press the UP and DOWN navigation keys to select or highlight a connection assignment in the list to be edited and press the EDIT softkey  to open the setup page for editing.
  - ➔ Parameters configured in the connections page include the port and the type of input or output assignment. Depending upon these selections the remaining fields will vary but could include the trigger, the template to be sent, and if checksum will be sent or not.
- 3 Press the UP and DOWN navigation keys to move the focus to the field to be edited or added.
- 4 Press the ENTER key to select a field to edit or add.
- 5 Use the selection boxes for each field to select the port, associated assignment, and desired settings for the connection. See table **Available Parameters, by Port and Assignment**.
- 6 Press the OK softkey  to accept the connection parameters and return to the Connections setup screen when editing or adding the connection assignment is complete.
- 7 Press the EXIT softkey  to return to the Connections setup page without saving the connection assignment edits or additions.

#### Delete A Connection

- 1 Use the UP and DOWN navigation keys to highlight a stored connection.
- 2 Press the DELETE softkey  to delete a connection assignment from the Connections list.

#### Clear All Connections

- 1 To clear all connection assignments in the Connection list, press the CLEAR softkey .
- 2 Press the OK softkey  to confirm the action.

Available Parameters, by Port and Assignment					
Port	Assignment	Trigger	Template	Checksum	# of Nodes
COM1/COM2/COM3/COM4/ COM5/COM6/Eprint1/Eprint2/ Eprint3/Eprint4/Print Client	Print Proxy	-	-	-	-

Available Parameters, by Port and Assignment					
Port	Assignment	Trigger	Template	Checksum	# of Nodes
COM1/COM2/COM3/COM4/ COM5/COM6	ASCII Input	-	-	-	-
COM1/COM2/COM3/COM4/ COM5/COM6/Eprint1/Eprint2/ Eprint3/Eprint4/Print Client	Continuous Extended	-	-	Disabled / Enabled	-
COM1/COM2/COM3/COM4/ COM5/COM6/Eprint1/Eprint2/ Eprint3/Eprint4/Print Client	Continuous Output	-	-	Disabled / Enabled	-
COM1/COM2/COM3/COM4/ COM5/COM6/Eprint1/Eprint2/ Eprint3/Eprint4/Print Client	Continuous Template	-	Template 1 - 5	-	-
COM1/COM2/COM3/COM4/ COM5/COM6/Eprint1/Eprint2/ Eprint3/Eprint4/Print Client	CTPZ Input	-	-	-	-
COM1/COM2/COM3/COM4/ COM5/COM6/Eprint1/Eprint2/ Eprint3/Eprint4/Print Client	Demand Output	Scale, Trigger 1...3	Template 1 - 5	-	-
COM1	Shared Data Server	-	-	-	-
COM1/COM3/COM4/COM5	Remote Discrete I/O	-	-	-	0, 1, 2, 3
COM1/COM2/COM3/COM4/ COM5/COM6/Eprint1/Eprint2/ Eprint3/Eprint4/Print Client	Reports	-	-	-	-
COM1/COM2/COM3/COM4/ COM5/COM6/Eprint1/Eprint2/ Eprint3/Eprint4	SICS	-	-	-	-
COM1/COM2/COM3/COM4/ COM5/COM6/Eprint1/Eprint2/ Eprint3/Eprint4/Print Client	Totals Report	Scale, Trigger 1...3	Template 1 - 5	-	-

#### Notes for connection options

- Not all choices are available for all connection assignments. Only valid choices are shown in the selection boxes.
- The Trigger field shows only when the assignment selection is Demand Output. The Trigger 1, 2, and 3 selections for Trigger enable connection of a separate softkey, discrete input or a PLC command to trigger the output of the selected template. The discrete selection must be programmed separately (refer to section [Discrete I/O ▶ Page 107] in the path Setup>Application>Discrete I/O, for additional details on programming discrete inputs, and to the IND500x PLC Interface Manual for details on triggering commands via supported PLC protocols).
- The Template field shows only when the assignment selection is Demand Output, Continuous Template, or Totals Report. Only 1 template can be assigned to each connection.
- The default template for the Totals Report is Template 5.
- The Checksum field is available for continuous outputs only.
- The SICS selection provides Level 0 and Level 1 interface commands. See Standard Interface Command Set (SICS) Protocol for details on the SICS protocol.
- If usage conflicts occur, an alarm message shows.
- EPrint offers a method to access the demand or continuous output data directly through the Ethernet port. The EPrint port is accessible only through the secondary port of the Ethernet interface, which can be configured in setup at Communication > Network > Secondary Port.
- The # of Nodes refers to the number of ARM100 Remote I/O modules that will be connected in series to the IND500x.

### 3.9.5 Serial

Serial communication setup screens provide access to the communication parameters for the serial ports COM1, COM2, COM3, COM4, COM5, and COM6.

NOTE: The COM2 and COM3 ports are only shown if the Ethernet/Serial option board is installed in the ACM500.

NOTE: The COM4 and COM5 ports can only be changed if their connection setup selection is "Standard".

If "Remote Discrete I/O" is selected as the port assignment at Communication >Connections, the port parameters are automatically preset and cannot be changed.

#### 3.9.5.1 COM1/COM2/COM3/COM4/COM5/COM6

The COM1, COM2, COM3, COM4, COM5, and COM6 setup screens are used to configure the parameters for serial ports.

##### Baud

The selection box is used to set the baud rate for the serial port. Selections include:

300, 600, 1200, 2400, 4800, **9600** [default], 19.2k, 38.4k, 57.6k, 115.2k

##### Data Bits

The selection box is used to set the number of data bits. Selections include:

7, **8** [default]

##### Parity

The selection box is used to set the parity. Selections include:

**None** [default], Odd, Even

##### Flow Control

The selection box is used to set the handshaking mode. Selections include:

**None** [default], XON-XOFF (software handshaking)

##### Interface

The selection box is used to select the serial port interface. Selections include:

COM1	RS-232 (can't be changed)
COM2	RS-232 (can't be changed)
COM3	<b>RS-232</b> [default], RS-422, RS-485
COM4	RS-232 (can't be changed)
COM5	RS-232 (can't be changed)
COM6	RS-232 (can't be changed)

### 3.9.6 Network

The Network branch shows only if the Ethernet TCP/IP option is installed. Programming selections in this branch depend on whether the option board is installed.

#### 3.9.6.1 Ethernet

Ethernet is available for TCP/IP transfer of data, shared data server access, connection via the EPrint port, email alerts, FTP, and saving and restoring configurations with InSite SL.

##### MAC Address

The Medium Access Control (MAC) Address can't be edited, and is shown for information only.

##### DHCP Client

If DHCP (Dynamic Host Configuration Protocol) Client is enabled, the IP Address, Subnet Mask, and Gateway Address fields are assigned automatically by the network. They become read-only in the setup screens. If Disabled, the IP address must manually be assigned in the following fields. Selections include:

**Disabled** [default], Enabled

### **IP Address**

The IP address for the IND500x terminal is entered in this field. This field is also used to view if DHCP Client is enabled. After each group of digits is entered, the ENTER key is entered to proceed to the next group. The default value for the IP is 192.68.0.1.

### **Subnet Mask**

The subnet mask for the IND500x terminal is entered in this field. This field is also used to view if DHCP Client is enabled. After each group of digits is entered, the ENTER key is entered to proceed to the next group. The default value for the subnet mask is 255.255.255.0.

### **Gateway Address**

The gateway address for the IND500x terminal is entered in this field. This field is also used to view if DHCP Client is enabled. After each group of digits is entered, the ENTER key is entered to proceed to the next group. The default value for the gateway is blank.

## **3.9.6.2 Port**

The Port setup screen shows the Share Data Server TCP/IP port number and also allows the TCP/IP port number to be configured for Eprint1, Eprint2, Eprint3, and Eprint4 on the same physical Ethernet Interface.

### **3.9.6.2.1 Shared Data Server Port**

The Shared Data Server Port number for the Ethernet TCP/IP interface is fixed at 1701, and is shown as a read-only field in Port setup screen. The TCP/IP port number can be modified through a Shared Data write.

### **3.9.6.2.2 Eprint Port**

If a valid and user-defined Eprint1 - 4 TCP/IP Port number is entered, the protocol or service assigned on the Eprint1-4 becomes accessible. The Eprint1 - 4 connection is configured in setup of Communication>Connections.

## **3.9.6.3 Print Client**

The Print Client connection allows the IND500x to send data directly to a specific IP address on the same network as the IND500x.

### **Server IP Address**

This field is used to enter the Server IP Address. The Server IP Address is the IP address of the device where the IND500x sends the print information. The default IP address is 0.0.0.0.

### **Server TCP Port**

This field is used to enter the server TCP port number for the device the data is to be sent to. The default port is 8000.

## **3.9.7 PLC**

The PLC parameters are only available when a PLC option is installed on the ACM500. The setup parameters shown depend upon which PLC option is installed. All PLC types except Analog Output also include a Data Format branch. When the PROFIBUS, PROFINET or Ethernet/IP interface is installed, an additional setting, Operating Mode, shows in the Data Format branch.

PLC setup screens include:

- Analog Output
- PROFIBUS
- PROFINET
- Ethernet/IP
- Data Format

### **3.9.7.1 Analog Output**

The IND500x terminal's analog output option provides either 4-20 mA or 0-10 volt DC outputs depending on how the connection is wired. The output can be configured to represent different source values.



## Source

This parameter determines what data will be used as the source of the analog output. Selections include:

None [default]	Analog output signal disabled
Application	Analog output signal controlled by a TaskExpert program
ABS – Displayed Weight	Analog output signal triggered on the absolute value of the displayed weight
ABS – Rate *	Analog output signal triggered on the absolute value of the rate
Displayed Weight	Analog output signal triggered on the displayed weight
Gross Weight	Analog output signal triggered on the gross weight
Rate *	Analog output signal triggered on the rate when Rate is enabled*



## Zero Value



The beginning zero value for the analog output can be adjusted. This value can be for weight or rate, depending on the selected source. In this field, the value at which the “zero” output of the analog signal should occur is entered.

## Full Scale Value

The beginning full scale span value for the analog output can be adjusted. This value can be for weight or rate, depending on the selected source. In this field, the value at which the “full scale span” output of the analog signal should occur is entered.

## Fine Adjustment of Zero and Span

If these preprogrammed values do not provide the exact outputs required, they can be trimmed by using the ZERO  and SPAN  softkeys located at the bottom of the screen.

- 1 Press the ZERO softkey  to initiate the zero fine-tuning process or the SPAN softkey  to initiate the span fine-tuning process. In either case, a warning screen offers 2 options – OK to continue with the operation, or EXIT to return to the Analog Output screen without making any adjustment.
  - ➔ The analog output signal value will change during this procedure. User is to ensure that the PLC or other control equipment is disconnected.
  - ➔ A warning message shows asking for verification to continue.
- 2 Press the OK softkey .
- 3 If necessary, use the softkeys that show to adjust the signal as follows:



### 3.9.7.2 Ethernet/IP

These parameters are used to program the operation of the Ethernet/IP option board. Additional interface information and programming examples can be found in the IND500x PLC Interface Manual.

#### MAC Address

The Medium Access Control (MAC) Address can't be edited, and is shown for information only.

#### DHCP Client

If DHCP (Dynamic Host Configuration Protocol) Client is enabled, the IP Address, Subnet Mask, and Gateway Address fields are assigned automatically by the network. They become read-only in the setup screens. If Disabled, the IP address must manually be assigned in the following fields. Selections include:

**Disabled** [default], Enabled

### **IP Address**

The IP address for the IND500x terminal is entered in this field. This field is also used to view if DHCP Client is enabled. After each group of digits is entered, the ENTER key is entered to proceed to the next group. The default value for the IP is 192.68.0.1.

### **Subnet Mask**

The subnet mask for the IND500x terminal is entered in this field. This field is also used to view if DHCP Client is enabled. After each group of digits is entered, the ENTER key is entered to proceed to the next group. The default value for the subnet mask is 255.255.255.0.

### **Gateway Address**

The gateway address for the IND500x terminal is entered in this field. This field is also used to view if DHCP Client is enabled. After each group of digits is entered, the ENTER key is entered to proceed to the next group. The default value for the gateway is blank.

## **3.9.7.3 PROFIBUS-DP**

The PROFIBUS DP Interface supports discrete data transfer that enables bi-directional communication of discrete bit-encoded information or 16-bit binary word (signed integer) numerical values.

Additional interface information and programming examples can be found in the IND500x PLC Interface Manual.

### **Node Address**

Each IND500x Terminal connected to the network represents one physical node. This address is determined by the system designer, then configured in the IND00x Terminal by selecting the Node Address text box and using the numeric keypad to enter the appropriate node address (0–125). The default value is 1.

### **Shared Data**

The Shared Data parameter enables or disables an extended message length that includes shared data access. This data is added to the end of the standard scale slot information and extends the message length. Selections include:

**Disabled** [default], Enabled

## **3.9.7.4 PROFINET**

These parameters are used to program the operation of the PROFINET option board. Additional interface information and programming examples can be found in the IND500x PLC Interface Manual.

### **MAC Address**

The Medium Access Control (MAC) Address can't be edited, and is shown for information only.

### **DHCP Client**

Program for DHCP (Dynamic Host Configuration Protocol) if the IP Address, Subnet Mask, and Gateway Address fields are assigned automatically by the network. They become read-only in the setup screens.

Selections include:

Disabled, Enabled

### **IP Address**

The IP address for the IND500x Terminal is entered in this field. When DHCP Client is enabled, the IP address is assigned automatically. When DHCP Client is disabled, the IP address can be entered manually. After each group of digits is entered, the ENTER key is pressed to proceed to the next group. The default value for the IP is 192.68.0.1.

### **Subnet Mask**

The Subnet Mask for the IND500x Terminal is entered in this field. This field is also used to view if DCP or DHCP is selected. After each group of digits is entered, the ENTER key is pressed to proceed to the next group. The default value for the Subnet Mask is 255.255.255.0.

### **Gateway Address**

The Gateway Address for the IND500x Terminal is entered in this field. This field is also used to view if DCP or DHCP is selected. After each group of digits is entered, the ENTER key is pressed to proceed to the next group. The default value for the gateway is blank.

## Device Name

This view-only field shows the device name as assigned by the PLC.

### 3.9.7.5 Data Format

The Data Format setup page is used to configure the PLC Data Format.

In Setup, navigate to Communication > PLC Interface > Data Format. The following must be configured for PROFINET.

#### Format

The Data Format is SAI.

#### Byte Order



Available selections are Little Endian, Byte Swap, Word Swap, Big Endian, Automatic.

#### Block Format

Available selections are 1, 2 and 4 blocks.

### 3.9.8 Reset

The Reset setup screen restores Communication branch setup values to their factory default settings.

- 1 To initiate a Reset, press the OK softkey .
  - ➔ If the Reset is successful, the verification message “**Reset Successful**” shows.
  - ➔ If the Reset is not successful, the error message “**Reset Failure**” shows.
- 2 If the Reset fails, try to initiate the Reset again.
- 3 If the Reset continues to fail, contact a local METTLER TOLEDO representative for assistance.
- 4 Press the EXIT softkey  to exit without resetting.

## 3.10 Maintenance

The configuration screens for the Maintenance branch of setup are shown below.

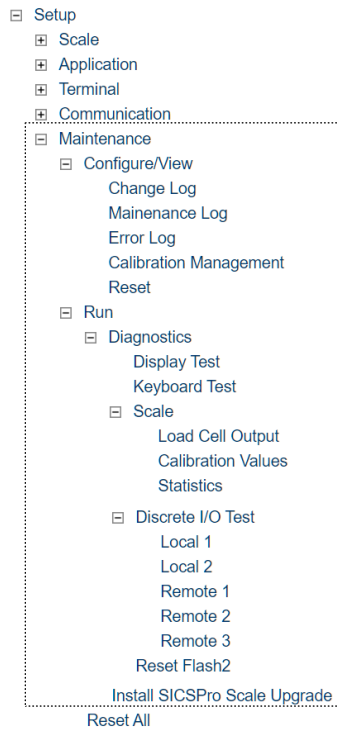

Figure 88: Setup Tree

### 3.10.1 Configure / View

The Configure / View setup branch provides access to parameters for Change Log, Maintenance Log, Error Log, and Calibration Management.

#### 3.10.1.1 Change Log

The change log file tracks changes to terminal configuration and shared data. The Change Log is approximately 150k bytes in size. Each record could vary in length, but the Change Log can store an average of 2,500 records.

Once the Change Log is full, it must be cleared or reset before additional entries (changes to settings and shared data) can be made.

The Change Log can be **Disabled** [default] or Enabled.







##### View Change Log Records

1 Press the VIEW TABLE softkey . The **Change Log** page shows.





Date	Time	User
12-Jul-2020	20:05:14	admin
13-Jul-2020	11:46:46	admin
13-Jul-2020	20:46:37	admin
14-Jul-2020	20:56:01	admin

Figure 89: **Change Log**

- 2 Press the FILTER OFF softkey .
- 3 In the Filter Settings page, use the Search Field 1 and Search Field 2 selection boxes and associated data fields to enter specific search information to limit the search by date, time, user, and object or leave the default \* (the "find all" character) to view all Change Log information.
- 4 Press the OK softkey  to launch the search operation.
  - ➔ The search results are shown in chronological order (The most recent change record displays at the end of the file with focus. Older records can be viewed by pressing the UP navigation key.).
  - ➔ Information shown includes **Date**, **Time**, User, **Object**, and **New Value**.
  - ➔ In this screen, user can press the FILTER ON softkey  to renew the search information, or press the FILTER CLEAR softkey  to clear the search information.
- 5 Press the TRANSFER softkey  to print the list to all Report connections.
- 6 Press the EXIT softkey  to return to the **Change Log** page.

##### Reset All Records in the Change Log File

- 1 Press the RESET softkey . A warning message shows to ask for verification that all configuration change records are to be reset.
- 2 Press the OK softkey . The configuration change records history is reset.
- 3 Press the EXIT softkey  to return to the **Change Log** screen without executing a reset.
- 4 If the reset is successful, a verification message "**Reset Successful**" shows. Press the ENTER key to acknowledge the reset and return to the **Change Log** screen.
- 5 If the reset fails, an error message "**Reset Failure**" shows. Try to initiate the reset again. If the reset continues to fail, contact a local METTLER TOLEDO service representative for assistance.

#### 3.10.1.2 Maintenance Log

The Maintenance Log is a record of routine maintenance or activities such as capture span and capture zero. The Maintenance Log is approximately 150k bytes in size. Records may vary in size, but the Maintenance Log will store an average of 2,500 records.

The Maintenance Log can be **Disabled** [default] or Enabled.

More details regarding the Maintenance Log can be found in chapter Table and Log File Structure and chapter Service and Maintenance.







## View Maintenance Log Records

- 1 Press the VIEW TABLE softkey . The **Maintenance Log** page shows.



Maintenance Log		
Date	Time	Username
12-Jul-2020	20:05:14	admin
13-Jul-2020	11:46:46	admin
13-Jul-2020	20:46:37	admin
14-Jul-2020	20:56:01	admin

Navigation icons: back, filter, search, forward, 1/2



Figure 90: **Maintenance Log**

- 2 Press the FILTER OFF softkey .
- 3 In the Filter Settings page, use the Search Field 1 and Search Field 2 selection boxes and associated data fields to enter specific search information to limit the search by date, time, username, event or leave the default \* (the "find all" character) to view all Maintenance Log information.
- 4 Press the OK softkey  to launch the search operation.
  - ➔ The search results are shown in chronological order (The most recent maintenance record shows at the end of the file with focus. Older records can be viewed by pressing the UP navigation key.)
  - ➔ Information shown includes **Date, Time, Username, Event Code, Status**.
  - ➔ In this screen, user can press the FILTER ON softkey  to renew the search information, or press the FILTER CLEAR softkey  to clear the search information.
- 5 Press the TRANSFER softkey  to print the list to all Report connections.
- 6 Press the EXIT softkey  to return to the **Maintenance Log** page.

### Reset All Records in the Maintenance Log File

- 1 Press the RESET softkey . A warning message shows to ask for verification that all configuration maintenance records are to be reset.
- 2 Press the OK softkey . The configuration maintenance records history is reset.
- 3 Press the EXIT softkey  to return to the **Maintenance Log** screen without executing a reset.
- 4 If the reset is successful, a verification message "**Reset Successful**" shows. Press the ENTER key to acknowledge the reset and return to the Maintenance Log screen.
- 5 If the reset fails, an error message "**Reset Failure**" shows. Try to initiate the reset again. If the reset continues to fail, contact a local METTLER TOLEDO service representative for assistance.

### Create A Maintenance Log Entry

- 1 Press the ADD softkey  on the Maintenance Log page.
  - ➔ The page **Add Maintenance Record** shows, where user can record the upgrade or repair of equipment. From this screen, an Event can be added, removed or replaced, and its status is recorded in an 8-character alphanumeric entry field.
- 2 Press the OK softkey  to confirm the change.
- 3 Press the EXIT softkey  to exit the page without changing the **Maintenance Log**.

### 3.10.1.3 Error Log

The Error Log is a record of significant errors that occur in the weighing system. Each record can vary in size, but the Error Log stores an average of 500 records.

The Error Log can be **Disabled** [default] or Enabled.





More details regarding the Error Log can be found in chapter Table and Log File Structure and chapter Service and Maintenance.

## View Error Log Records



1 Press the VIEW TABLE softkey . The **Error Log** page shows.

Error Log	
Start Date	Start Time
12-Jul-2020	20:05:14
13-Jul-2020	20:06:46
13-Jul-2020	20:07:37
14-Jul-2020	20:08:01

Figure 91: **Error Log**

- 2 Press the FILTER OFF softkey .
- 3 In the Filter Settings page, use the Search Field 1 and Search Field 2 selection boxes and associated data fields to enter specific search information to limit the search by date, time, severity, count, error code, or leave the default \* (the "find all" character) to view all Error Log information.
- 4 Press the OK softkey  to launch the search operation.
  - ➔ The search results are shown in chronological order (The most recent error record shows at the end of the file with focus. Older records can be viewed by pressing the UP navigation key.).
  - ➔ Information shown includes **Start Date, Start Time, Last Date, Last Time, Severity, Error Code, Counts, and Message.**
- 5 Press the TRANSFER softkey  to print the list to all Report connections.
- 6 Press the EXIT softkey  to return to the **Error Log** page.

### Reset All Records in the Error Log File

- 1 Press the RESET softkey . A warning message shows to ask for verification that all configuration error records are to be reset.
- 2 Press the OK softkey .
- 3 Press the EXIT softkey  to return to the **Error Log** screen without executing a reset.
- 4 If the reset is successful, a verification message "**Reset Successful**" shows. Press the ENTER key to acknowledge the reset and return to the **Error Log** screen.
- 5 If the reset fails, an error message "**Reset Failure**" shows. Try to initiate the reset again. If the reset continues to fail, contact a local METTLER TOLEDO service representative for assistance.

### 3.10.1.4 Calibration Management

Calibration management includes a test interval to program how much time elapses between calibration checks. When this time is exceeded, an expiration action is initiated. The type of expiration action is also programmable. This feature is disabled by entering zero into the interval days.







Parameters Configuration		
Item	Options	Description
Event	Calibration	Only when the Event type is selected as Custom Name Event, the Custom Event Name field shows for name editing.
	Sensitivity	
	Eccentricity	
	Repeatability	
	1-Point	
	Walk-Test	
	Custom Event Name	
Interval Days	-	The Event Interval is specified in days in this field.
On Overdue	No Action	This field is used to configure the activity to occur upon expiration of the calibration.
	Grey Weight	
	No Weight	

Parameters Configuration		
Item	Options	Description
Reminder Days	-	The Reminder Days before the due date is specified in this field.
Last Date	-	Last Calibration/Service Date and time.
Due Date	-	Next scheduled due date and time
Reminder Date	-	Reminder date

### View the Events

- When Calibration Management is focused or highlighted in the main menu, press the ENTER key to show the Event View page.
  - ➔ The Event View page shows with the events sorted in chronological order (The most recent event shows at the front of the list with focus. Older events can be viewed by pressing the DOWN navigation key.).
  - ➔ A maximum of 10 events can be added to the Event List.

### Create A New Event

- 1 In the Event View page, press the ADD softkey  to add a new Event record.
- 2 In the Event Edit page shown, select the Event type, interval days, overdue action, and reminder days. See the table **Parameters Configuration**.
  - ➔ The RESET softkey  shows only in the last 2 pages of the setting page. Last Date, Due Date and Reminder Date can be reset by pressing the RESET softkey . When the RESET softkey  is pressed, a warning message shows to ask for verification that dates are to be reset.
- 3 Press the OK softkey . The dates are reset.
- 4 Press the EXIT softkey  to return to the main menu without resetting the value.
  - ➔ If the reset is successful, a verification message “**Reset Successful**” shows. Press the ENTER key to acknowledge the reset and return to the Calibration Management screen.
  - ➔ If the reset fails, an error message “**Reset Failure**” shows. Try to initiate the reset again. If the reset continues to fail, contact a local METTLER TOLEDO service representative for assistance.

### Edit An Existing Event



- 1 In the Event View page, use the UP and DOWN navigation keys to select an Event in the list.
- 2 Press the EDIT softkey  to edit the selected Event record.
- 3 In the Event Edit page, edit the related values.

### Delete An Existing Event

- 1 In the Event View page, use the UP and DOWN navigation keys to select an Event in the list.
- 2 Press the DELETE softkey  to delete an Event record.

#### 3.10.1.5 Reset

The Reset setup screen restores Maintenance>Configure / View branch setup values to their factory default settings.

- 1 To initiate a Reset, press the OK softkey .
  - ➔ If the Reset is successful, the verification message “**Reset Successful**” shows.
  - ➔ If the Reset is not successful, the error message “**Reset Failure**” shows.
- 2 If the Reset fails, try to initiate the Reset again.
- 3 If the Reset continues to fail, contact a local METTLER TOLEDO representative for assistance.
- 4 Press the EXIT softkey  to exit without resetting.

#### 3.10.2 Run

The Run screens enable the operator to run the diagnostic tests, serial test, and discrete I/O tests. In addition, the scale data can be accessed.

### 3.10.2.1 Diagnostics

#### 3.10.2.1.1 Display Test

- 1 In the main menu, move the focus to the **Display Test** branch.
- 2 Press the ENTER key.
  - ➔ The **Display Test** starts. The screen switches color display in the sequence of red, green, blue, black, and white.
- 3 In the process of color switching, observe carefully if different color blocks exist in the current display.

#### 3.10.2.1.2 Keyboard Test

The Keyboard Test screen enables testing of the terminal keys, including softkeys, scale function keys, navigation keys, and alphanumeric keys.

- 1 In the main menu, move the focus to the **Keyboard Test** branch.
- 2 Press the ENTER key. The **Keyboard Test** page shows.

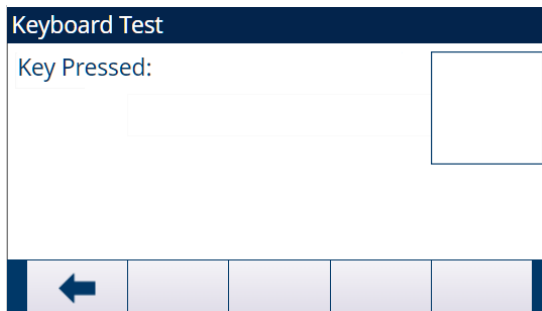

Figure 92: Keyboard Test

- 3 Press a key. A symbol representing the key pressed shows on the top right corner of the screen.

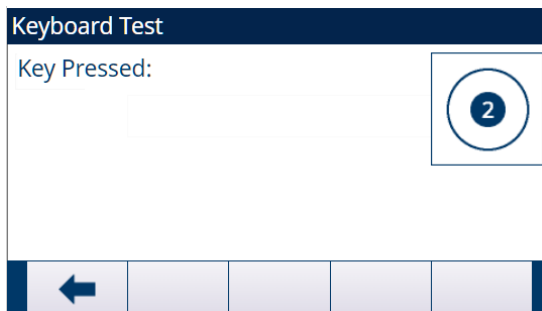

Figure 93: Keyboard Test

#### 3.10.2.1.3 Scale

##### Load Cell Output

The Load Cell Output screen shows the current number of counts (active value) for an analog scale. This function is not available for IDNet scale or SICSpro scale.

User can press the EXIT softkey  to return to the menu tree.

##### Calibration Values

The Calibration Values screen displays the current calibration values configured for the scale. This display is not available for IDNet and SICSpro scale types. The number of test loads that display calibration values is determined by the Linearity Adjustment setting configured for the scale (see the chapter [Linearity Adjustment ▶ Page 67] in Calibration>Scale \_Analog>Scale>Configuration).

These calibration values can be recorded and then manually entered into a new replacement board should a failure ever occur. This makes it unnecessary to recalibrate the scale with test weights. While this method is quick, it is not as accurate as placing test weights on the scale.



User can use the UP and DOWN navigation keys to select a calibration value to be modified, and use the numeric keypad to enter new values.

For calibration with hysteresis, zero load always has only one count value; all other test loads between zero and full test load always have two sets of counts. The left set of counts is captured during loading and the right set of counts during unloading. The full test load always has only one count field.







### Statistics

The Scale Statistics screen shows statistical information for the scale such as Weighments (increments each time a transaction is triggered), Overloads (increments when the applied load for a single load cell exceeds its overload capacity), Peak Weight (the maximum weight recorded by the scale), and Zero Commands (increments each time a zero command is received from an operator or remotely).

User can use the UP, DOWN, LEFT, and RIGHT navigation keys to view all information and records, and use the EXIT softkey  to return to the menu tree.

#### 3.10.2.1.4 Discrete I/O Test

Discrete I/O Test setup screens include Local 1, Local 2, Remote I/O 1, Remote I/O 2, and Remote I/O 3.

- 1 Select the internal (local) or external (Remote I/O) to be tested from the menu tree. Press the ENTER key to confirm the selection.
  - ➔ A pop-up message "Remote ARM100 communication failure" shows if the ARM100 doesn't exist or is offline due to error.
  - ➔ When any of the Discrete I/O Test screens are first accessed, a warning message shows with instructions to remove output control power before proceeding with the test. The Discrete I/O Test screens enable manual setting of any of the outputs to ON or OFF for testing. So to avoid activating externally connected devices, output control power must be removed before proceeding.
- 2 Press the EXIT softkey  to abort and not perform the test.
- 3 Press the OK softkey to continue the test.
  - ➔ A real-time display shows the status of each of the inputs and enables each of the outputs to be turned on and off. An input or output that displays  is turned off. An input or an output that displays  is turned on.
- 4 Use the LEFT and RIGHT navigation keys to select an output to turn on or off.
- 5 Press the DISCRETE OFF softkey  to turn the output off, and press the DISCRETE ON softkey  to turn the output on.
- 6 Press the EXIT softkey  to return to the menu tree. The outputs return to their previous ON/OFF status before the tests were initiated.

If three remote I/O modules are configured in the terminal, the IND500x disables the ability to run diagnostics on a local I/O board that may be installed.

#### 3.10.2.1.5 Reset Flash 2

The Reset Flash 2 function clears the Flash 2 memory of all program files, custom tables and bitmap files specific to TaskExpert custom programs downloaded to the terminal. Only the A1.csv (Tare Table), A2.csv (Target Table), A3.csv (Container Tare Table available in the Fill-500x only) and A4.csv (Formula Table available in the Fill-500x only) will remain in place with intact structures during reset of the Flash 2 drive.

- 1 Press the START softkey  to initiate a reset of the Flash 2 memory.
  - ➔ The terminal does not prompt the user for confirmation and the reset begins immediately.
  - ➔ The message "Reset Successful" shows when the reset is complete.
- 2 Press the ENTER key to acknowledge the status. The terminal completes a power cycle.



### 3.10.3 Reset All

The Reset All setup screen restores Maintenance branch setup values to their factory default settings.

#### Note:

The Reset All function resets all parameters in the terminal, except metrologically significant settings such as Scale type, capacity, etc.

When the Reset All screen is first accessed, a message displays that asks for verification to reset all setup parameters to factory default settings.

- 1 To initiate a Reset, press the OK softkey .
  - ➔ If the Reset is successful, the verification message "**Reset Successful**" shows.
  - ➔ If the Reset is not successful, the error message "**Reset Failure**" shows.
- 2 If the Reset fails, try to initiate the Reset again.
- 3 If the Reset continues to fail, contact a local METTLER TOLEDO representative for assistance.
- 4 Press the EXIT softkey  to exit without resetting.

## 4 Maintenance and Service

The IND500x terminal is designed to provide years of dependable operation. However, METTLER TOLEDO recommends that – as with any industrial measurement equipment – the IND500x terminal and the connected scale system be serviced periodically. Timely, factory specified maintenance and calibration by a METTLER TOLEDO service technician will ensure and document accurate and dependable performance to specifications. If unexpected problems do occur, METTLER TOLEDO recommends that service be done only by qualified, trained personnel. To assist in this repair, record as much information as possible about what has happened including any error messages and physical responses of the terminal and/or scale.

### 4.1 Terminal Cleaning and Maintenance

#### Clean the Keypad and Cover

1. Gently wipe the IND500x terminal's keypad and cover with a clean, damp, and soft cloth.
2. Use water or mild, non-abrasive cleaning agents.
3. Do not use any type of acids, alkalis or strong industrial solvents such as toluene or isopropanol (IPA) that could damage the terminal's finish.
4. Do not spray cleaner directly on the terminal.
5. Do not clean the terminal using high-pressure or high-temperature water.
6. Avoid build-up of dust layers.
7. Remove light dust deposits using a damp cloth with a gentle wiping motion.
8. Do not use compressed air or vacuum to remove dust layers.
9. Follow good housekeeping practices to keep the terminal clean.

#### Terminal Maintenance

Regular maintenance inspections and calibration by a qualified service technician are recommended.



#### **WARNING**

##### **Damaged keyboard, display lens or enclosure**

Body harm and / or property damage.

- 1 Repair the defective component immediately.
- 2 Remove power immediately and do not reapply power until the display lens, keyboard or enclosure is repaired or replaced by qualified service personnel.

#### 4.1.1 Overlay and Gasket

##### Overlay

The IND500x is a rugged stainless steel enclosed instrument; however, the front panel is a polyester covering over sensitive electronic switches and a lighted display. Care should be taken to avoid any punctures to this surface or any vibrations or shocks to the instrument.

The overlay should be inspected during maintenance, and replaced if it is damaged. Should the front panel overlay become punctured, the IND500x should be taken out of service until the overlay can be replaced.

##### Gasket

Each time the Harsh enclosure is opened, the gasket should be inspected for tearing, deterioration, and damage.

### 4.2 Service



#### **WARNING**

##### **Inappropriate service measures**

Body harm and / or property damage

- 1 Only permit qualified personnel to service the terminal.
- 2 Exercise care when doing checks, tests and adjustments with power ON.

Only qualified personnel should perform installation, programming, and service. Please contact a local METTLER TOLEDO representative for assistance.

In general, once the IND500x is installed, programmed, and calibrated for a given application, only routine calibration service is required.

## 4.2.1 General Safety Guidelines for Service

When performing on-site service or maintenance in the hazardous area, only carry out this work on the weighing terminal if the following conditions are fulfilled:

- The certification papers (conformity certificates, control drawing, manufacturer certifications, etc.) are present and can be used to confirm the correctness and safety of the installation.
- The intrinsically safe entity parameters and area approval of the individual components are in accord with one another.
- The customer has issued a permit ("spark permit" or "fire permit").
- The area has been rendered safe and the owner's safety coordinator has confirmed that there is no danger.
- The necessary tools and any required protective clothing are provided (danger of the build-up of static electricity).

## 4.3 Upgrade the Firmware

### 4.3.1 Upgrade the Terminal Firmware

The InSite™ CSL configuration tool program is used to flash new terminal firmware to the IND500x. The firmware update and the InSite™ CSL configuration tool program must be saved on a PC that will be connected to the terminal for firmware flashing. Hyperterminal, a standard Windows program, is also an option for flashing firmware to the IND500x.

Access is only available through COM1/COM3/COM4 for terminal firmware upgrade via InSite.

The IND500x firmware is possible to be upgraded in the ways that follow:

- Via the intrinsically safe COM1 serial port on the main board of the IND500x. An appropriate barrier, MTL7761Pac (IECEx and ATEX approvals) is required to connect a PC directly to COM1. If possible, take the IND500x to Safe area and directly connect it to PC via COM1 to update firmware.
- Via COM3 located on the Ethernet/COM2/COM3 option board installed in the ACM500. (After COM3 connection is established, power off IND500x and ACM500. After that, power on ACM500 first and then IND500x.)
- Via COM4 of the intrinsically safe current loop interface of the IND500x and the ACM200.

#### 4.3.1.1 Perform the Terminal Firmware Upgrade with InSite CSL

- 1 Double click the InSite™ CSL icon  to access the configuration tool.
  - ➔ The new firmware generates a checksum error on restart, which can be cleared by pressing the ENTER key on the terminal. This performs a Factory Reset. Therefore, it is important to use InSite™ CSL to back up the current configuration and table data before performing the upgrade.
- 2 Remove power from the terminal.
- 3 Open the terminal enclosure. See Opening the Enclosure
- 4 Set the SW1-1 switch to the position OFF (if not in the OFF position) and the SW1-2 switch to the position ON. See [Main PCB ▶ Page 16] for switch locations.
- 5 Apply power to the terminal.
- 6 The Serial port download screen shows with a list of parameters for the serial port download (these parameters cannot be changed). The serial port on the PC must be programmed to match these parameters. This is done automatically in the InSite™ CSL program. Parameters listed include:  
Baud Rate: 115200  
Data Bits: 8  
Parity Bit: None  
Stop Bits: 1  
Flow Control: None

- 7 Connect the serial port cable from the PC that contains the firmware update and the InSite™ CSL configuration tool program to the barrier and then the barrier communication cable to the IND500x terminal.

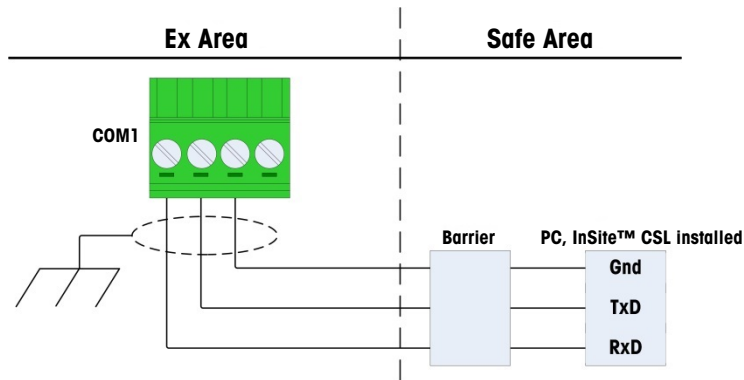



Figure 94: COM1 Connection via Cables and Barrier

- ➔ The terminal is ready for firmware flashing.
- 8 Click the Flash Download icon . Refer to the instructions / help provided with the InSite™ CSL configuration tool program for procedures required to complete firmware flashing.
  - 9 When the firmware download process is complete, disconnect the serial cables, return switch SW1-1 to its original position and turn the SW1-2 switch to OFF.
  - 10 Close the terminal enclosure.
  - 11 After flashing new firmware, a Factory Reset is required.

## 4.3.2 Upgrade the SICSPRO Scale Firmware

### 4.3.2.1 Upload SICSPRO Scale Firmware

IND500x supports two kinds of SICSPRO Scale, PBK/PFK and AJB. If firmware is to be uploaded into terminal flash, the name should be different. PBK/PFK firmware should be named as **UpgradePBKPFK.mot**, and AJB firmware should be named as **UpgradeAJB.mot**.

#### Perform the SICSPRO Scale Firmware Upgrade with InSite™ CSL

Access is available through COM1/COM3/COM4/COM5 for SICSPRO scale firmware uploading via InSite.

**Note** The Dip Switch SW1-2 needs to be set to the position Off.

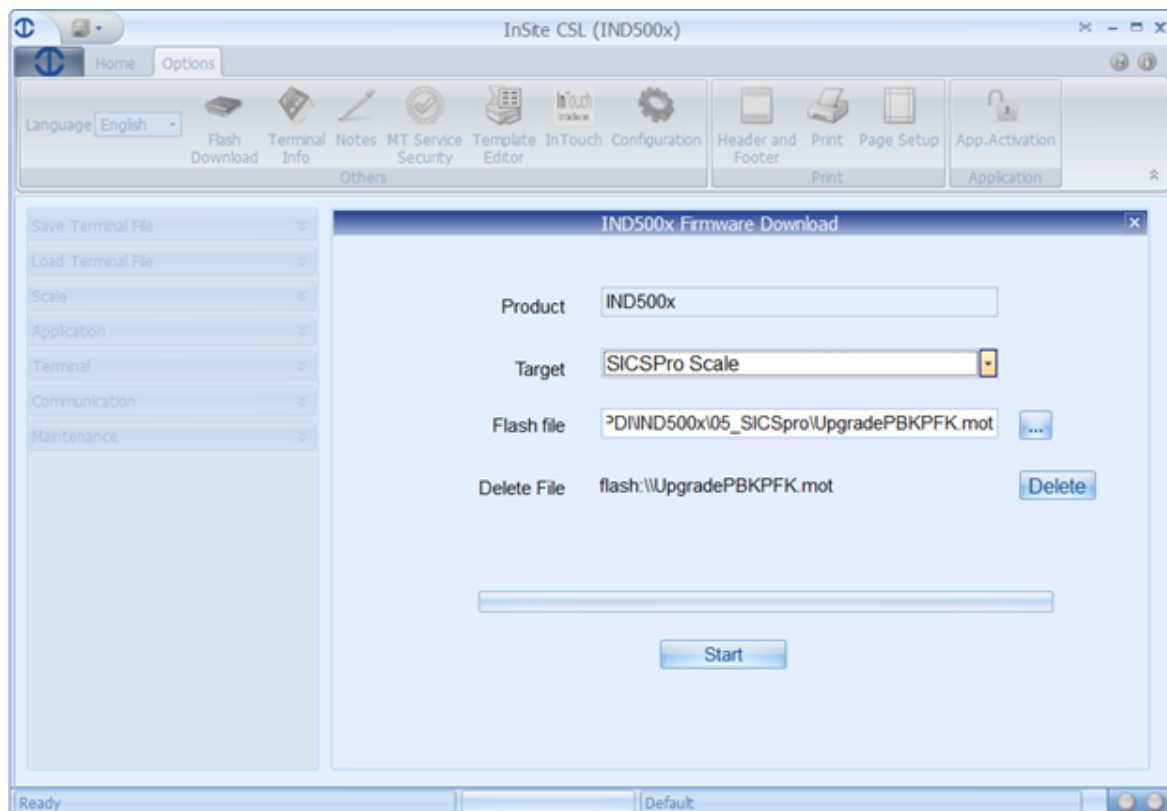

Figure 95: InSite

#### **Communication with InSite via Serial Connection, with COM1 as example**

- 1 Enter the Communication>Connections setup page, and configure COM1 as Shared Data server.
- 2 Enter the Communication>Serial setup page, and configure the COM1 parameters as below:  
Baud Rate: 115200  
Data Bits: 8  
Parity: None  
Flow Control: None
- 3 Select the correct port number in InSite and then click OK.
- 4 Click Connect and enter the user name and password to start communication with IND500x.
- 5 Navigate to options and select Flash Download.
- 6 Select the target SICSPRO Scale.
- 7 Select the Flash file.
- 8 Start the firmware download.

#### **4.3.2.2 Install SICSPRO Scale Upgrade**

If terminal is sealed, both two kinds of upgrade are not allowed.

##### **Automatic Upgrade**

Automatic upgrade only happens when the IND500x terminal is connected to the SICSPRO scale for the first time.

If IND500x find the scale firmware only supports ASM2, it would upgrade to support ASM3. This scale firmware with ASM3 is stored in IND500x flash disk.

- 1 When the terminal is powered up, the message "**SICSPRO Base S/W Upgrade**" pops up.
- 2 Press the ENTER key to confirm the upgrade.

➔ The screen shows the loading status.

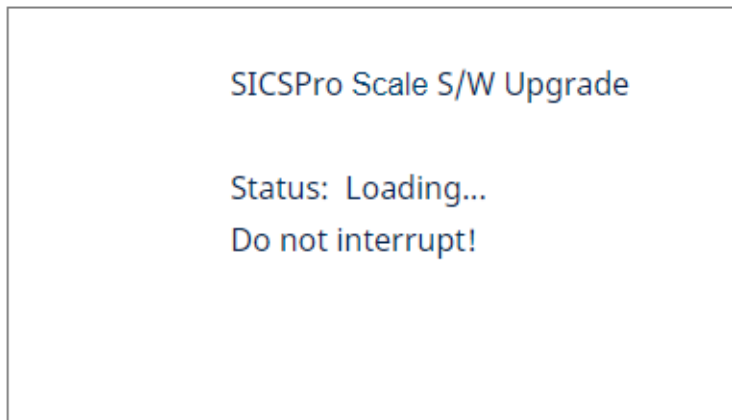

Figure 96: Loading Status

3 Upon the upgrade, a message "Upgrade Successful" or "Upgrade Failure" will show.



4 If no correct SICSPRO scale firmware is found in Flash, a message box pops up to require firmware upload.

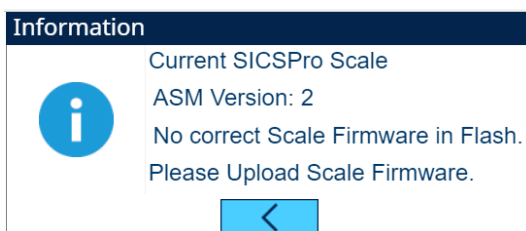



Figure 97: SICSPRO Scale Upgrade

### Manual Upgrade

- 1 Press the SETUP softkey  in the Home Page.
- 2 Move the focus to Install SICSPRO Scale Upgrade branch by following the path: Setup>Maintenance>Run>Install SICSPRO Scale Upgrade. Press the ENTER key.
  - ➔ The Install SICSPRO Scale Upgrade page shows. If no correct SICSPRO scale firmware is found in Flash, a message box pops up to require firmware upload.

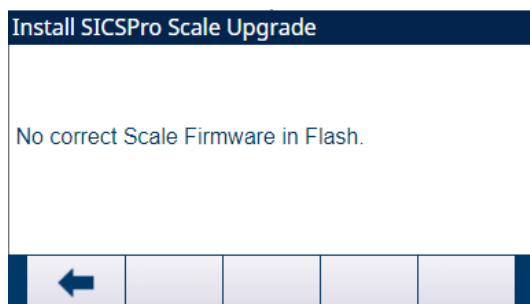

Figure 98: SICSPRO Scale Upgrade\_Manual

3 Press the START softkey  to confirm the firmware upgrade.

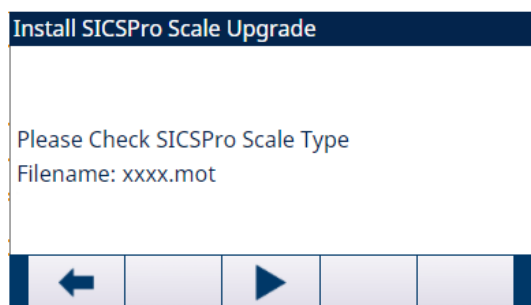

Figure 99: SICSPRO Scale Upgrade\_Manual

- ➔ Upon the upgrade, a message “Upgrade Successful” or “Upgrade Failure” will show.
- ➔ The SICSPRO scale upgrade is installed.

## 4.4 Display Messages

### 4.4.1 Application Key Error

If, on power-up, the terminal finds that the hardware application key status is changed (switch between the Fill PAC and the Manual Formulation PAC), a fault message shows. For instance, if the Fill Pac hardware key is added to a standard IND500x, the fault would be shown at power up.



Figure 100: Application Key Fault

Even though the ENTER graphic is shown, the ENTER key does not function. Two responses to this error are possible:

- If the hardware key status is not changed on purpose, turn the power off and determine what causes the status to change. Fix the problem and apply power again. The terminal retests the hardware key status.
- If the hardware key status is changed on purpose by adding or removing a key, perform a manual Master Reset – refer to Master Reset under Troubleshooting, below.

**Note:** Back up the terminal’s current setup parameters before the hardware key status is changed. The original setup can then be downloaded to the terminal after the Master Reset.

### 4.4.2 COM4 Error / COM5 Error

A “COM4 Error” and / or “COM5 Error” message shows in the system line of the IND500x if:

- The setting at Communication > Connections > COM4 or COM5 is ACM500, and the IND500x does not register communication from the ACM500 when it is powered up, or
- Communication is lost between the IND500x and ACM500.

For troubleshooting assistance, refer to the [Error Message ▶ Page 151] section later in this chapter.



Figure 101: COM4 / COM5 Error



### 4.4.3 Invalid Parameters

The IND500x would show an "Invalid Parameters" message in the system line when exiting the setup menu. This happens when the weighing mode is set to "Over/Under" but no active Target value is established. As long as a Target is set up, the "Invalid Parameters" message will no longer show.



Figure 102: Invalid Parameters

## 4.5 Set A Custom Language

The IND500x terminal allows custom languages to be selected for display messages. The IND500x can store up to two custom language files at any one time. Any 2-language combination can be stored in the IND500x providing that one language file is named cust.txt and the second language file is named cust2.txt.

The following list contains all of the languages currently available for the IND500x:

English  
Chinese  
French  
German  
Italian  
Polish  
Portuguese  
Russian  
Spanish.

Contact your METTLER TOLEDO technical support provider to obtain custom files for download to the terminal.

- A properly-configured text file, named either cust.txt or cust2.txt, contains a complete set of display messages in the custom language.
  - 1 Make an ftp connection to the terminal.
  - 2 On the terminal, access Setup>Terminal>Region>Languages.
  - 3 In the Display Messages field dropdown list, select Custom or Custom2 as appropriate.
  - 4 Exit setup.
    - ➔ Messages on the terminal's display show in the custom language.
    - ➔ A custom language is set.

## 4.6 Error Management

### 4.6.1 Smart5® Introduction

Smart5® is intended to harmonize events and alarms based on industry standards and common industry practice. These standards originated from the process control industry in chemistry, oil production and refining where there is a very high risk of explosion and bodily harm.

Some of the Smart5® alarms can also be observed at the PLC side. User can refer to the chapter [Error Message ▶ Page 151] for details.

#### 4.6.1.1 Events and Alarms

In the operation of a weighing device there are two conditions that must be monitored. One is Event and the other is Alarm.

An event can be as simple as a weighing cycle or the indication of an out of tolerance condition, which are significant enough for the system to indicate an error or inform the customer. Events are accumulated in a log file for predictive analytics, and can ultimately be escalated to a maintenance event that triggers an alarm.

An alarm is the ultimate error condition because it is used to communicate the condition to the customer immediately. An alarm condition, may be connected to a physical output, is logged in an alarm file, and is transmitted through the automation and/or IT interface to the customer.

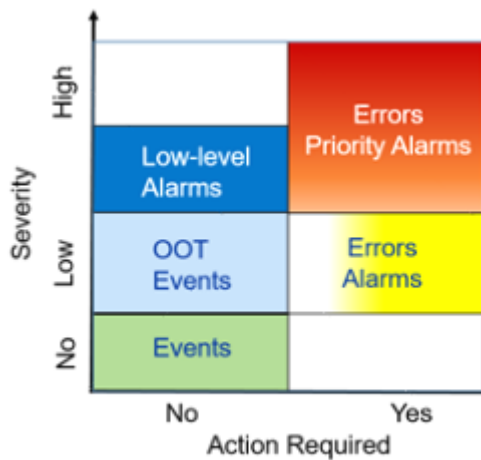

Figure 103: Severity and Required Action Contrast between Events and Alarms



**Event** Event is defined as a state change, a condition, an Out of Tolerance (OOT) state or a low-level error condition that will be logged for use by predictive analytics. Events are non-critical to the operation of a weighing device and thus do not need corrective actions. Selected events which accumulate over a long period of time can lead to alarm conditions. For example 100,000 weighing transactions would drive a low-level alarm signifying that a preventative maintenance, routine test or calibration must be undertaken.



**Alarm** Indicates an error as a result of an improper operator action, or an out of tolerance condition that must be logged in an alarm file and, depending on the criticality of the error, transmitted through the automation or IT interface. Depending on type, severe errors usually require a service intervention. In the worst case, at the customer’s discretion, the device would be disabled.

#### 4.6.1.2 NAMUR Alarm / Alert Classification

NAMUR/Smart5® Error are caused by technical problems of the Terminal/Scale/Operation, normally NAMUR/Smart 5® Error are those errors that occur (from the operator’s view) randomly and not as a direct result of operator interaction with the terminal.

The table that follows is an adaptation of NE107 for weighing devices.

Icon	Rank	Type	Description	Result
	5	Catastrophic failure	Wrong weight / equipment failure	Alarm stops operation: Clearing the alarm will not reset the condition – the device must be repaired to eliminate the alarm
	4	Imminent failure	Wrong weight / equipment failure expected based on predictive algorithms and sensors like temperature, humidity.	Alarm indicates failure is imminent within a period of one week or more. The alarm can be reset but will recur each day until the cause is eliminated
	3	Out of specification	Wrong Operator Actions or device / application is operating out of specification	Alarm and log the event. Alarms are only generated / transmitted at the request of the customer.

Icon	Rank	Type	Description	Result
	2	Predictive Alarm	Routine test, Calibration or Preventative maintenance must be undertaken.	Alarm and log the event. Alarms are only generated / transmitted at the request of the customer.
	1	Normal Condition	Unit is operating correctly.	No action required.

#### 4.6.2 Error Log

The IND500x provides an Error Log which records the details of system errors. The log can save up to 500 records. Each error record includes:

Field	Format	Comments
Timestamp (start)	Timestamp	The start time the error occurred
Timestamp (last)	Timestamp	The last time the error occurred
Severity	5 / 4 / 3 / 2	5 = Fatal 4 = Critical 3 = General Alarm 2 = Alert
Error Code	1025	Refer to Smart5® [Error List ▶ Page 151].
Counts	1	How many times this error happened in last period.
Message	Text	Cause and scenario of errors
Action	Text	Actions necessary to address the error

When Error Log is exported as errlog.csv, each of these fields is separated by ';', ASCII code 44 (0x2C in HEX code).

Two sample records are shown below. The first indicates that the tare is out of tare range, while the second shows that Tare while weight is more than 0.

- 2021/01/01,08:01:01, 2,00004054, 0001, "out of tare range", "Tare weight exceeds"
- 2021/01/01,09:01:01, 2,00004055, 0001, "The weight is less than 0", "Tare while weight more than 0"

This Log file errlog.csv can be exported via ftp or via serial port or Ethernet using the 1K Xmodem protocol and the Parameter server.is located in flash2:\\errlog.csv.

#### 4.6.3 Error Message

Message (TFT Display)	Alarm Code	Namur Level	Error Log	I/O	Description	Action
Control Network Failure	2011	5	Y	N	The cyclic communication between IND500x and PLC failed.	Check the NW connection.
Scale Disconnected	2012	5	Y	Y	The IND500x cannot find the Analog/Precision scale or load cell connection.	Check scale connection cable.
Remote *** Error	2015	4	Y	Y	Triggered when Remote Discrete IO (ARM100) communication fails.	Check Remote Discrete IO communication.
Change Log exceeds 75%	3031	2	Y	N	Change Log Records Number exceeds 75% of Maximum Records.	Export the log file.
Maintenance Log size 100%	3032	3	Y	N	Maintenance Log Records Number exceeds Maximum Records.	Export the log file.

Message (TFT Display)	Alarm Code	Namur Level	Error Log	I/O	Description	Action
Maintenance Log exceeds 90%	3033	2	Y	N	Maintenance Log Records Number exceeds 90% of Maximum Records.	Export the log file.
Maintenance Log exceeds 75%	3034	2	Y	N	Maintenance Log Records Number exceeds 75% of Maximum Records.	Export the log file.
Calibration Log size 100%	3035	3	Y	N	Calibration Log Records Number exceeds Maximum Records.	Export the log file.
Calibration Log exceeds 90%	3036	2	Y	N	Calibration Log Records Number exceeds 90% of Maximum Records.	Export the log file.
Calibration Log exceeds 75%	3037	2	Y	N	Calibration Log Records Number exceeds 75% of Maximum Records.	Export the log file.
Transaction Log size 100%	3038	3	Y	N	Transaction Log Records Number exceeds Maximum Records.	Export the log file.
Transaction Log exceeds 90%	3039	2	Y	N	Transaction Log Records Number exceeds 90% of Maximum Records.	Export the log file.
Transaction Log exceeds 75%	3040	2	Y	N	Transaction Log Records Number exceeds 75% of Maximum Records.	Export the log file.
File export fail	3041	3	Y	N	Fail to Export File.	Check connection and try again.
File import fail	3042	3	Y	N	Fail to Import File	Check connection and try again.
There are orders in progress!	3043	3	Y	N	Fail to Import Recipe because current Recipe is in Use.	Check unfinished orders.
Analog Converter Fail	4041	5	Y	Y	A-to-D converter cannot work normally, A-to-D processing task does not read AD data for more than 1s.	Check scale connection cable.
Zero Fail Motion	4042	0	N	N	Zero failed because of motion.	Make less change to the load on scale and zero again.
Zero Fail Net	4043	0	N	N	Zero scale is not permitted when scale in net mode.	Remove load from scale.
Zero Out of Range	4044	2	Y	N	Zero scale is not permitted when load on scale is out of zero range.	Remove load from scale.
Zero Disabled	4045	0	N	N	Push Button Zero disabled.	Enable the function in menu and zero again.
Tare Fail Motion	4046	0	N	N	Tare failed because of motion.	Make less change to the load on scale and tare again.
PB Tare Disabled	4047	0	N	N	Push Button Tare disabled.	Enable the function in menu and tare again.
KB Tare Disabled	4048	0	N	N	Keyboard Tare disabled.	Enable the function in menu and tare again.

Message (TFT Display)	Alarm Code	Namur Level	Error Log	I/O	Description	Action
Chain Tare Not Permitted	4049	0	N	N		
Only Incremental Chain	4050	0	N	N		
Tare Round Fail	4051	0	N	N	Only a rounded value is allowed for Preset Tare.	Use a rounded value for Preset Tare and tare again.
Tare Too Small	4052	0	N	N	The scale is too large for this item to be tared.	Change to a suitable scale; or change the increment.
Zero Init. Fail	4053	0	N	N	Tare is not permitted when Power-up Zero fails.	Remove load from scale.
Tare out of Range	4054	0	Y	N	Tare weight exceeds capacity.	Remove load from scale.
Tare Negative Fail	4055	0	N	N	Tare is not permitted when the weight value is negative.	Zero the scale.
Tare Failed-Over (range)	4056	0	Y	N		
Clear Tare-Gross Zero	4057	0	N	N		Remove load from scale.
Tare Failed - Unknown	4058	0	N	N	Clear Tare function is disabled in menu.	Enable the function in menu and clear again.
Analog Saturation Fail	4059	0	N	N	Weight far exceeds scale capacity.	Remove load from scale.
Trade Overload	4064	3	Y	Y	Scale is too small for this item.	Change to a suitable scale.
Trade Underload	4065	3	Y	Y	The current load on scale is less than zero point.	Zero again.
SW1-1 OFF After Being ON	4066	3	Y	N	Scale not for commercial use.	-
Sample size too small	4067	3	Y	N	The sample weight is too small.	Choose a smaller scale for this item.
Adjustment failure	4069	3	Y	N	Adjustment process failed.	Try a new adjustment.
MP Adjustment Failure	4070	3	Y	N	The multi-point adjustment process failed.	Try a new adjustment.
Change Log size 100%	4071	3	Y	N	The change log file is full.	Export the log file.
Change Log exceeds 90%	4072	2	Y	N	The change log file is 90% full.	Export the log file.
Zero Required	4074	3	N	Y	Timed Zero Enabled, but Timed Zero Expired	Zero
Sensitivity Overdue. Please Run Sensitivity Test	4075	2	Y	N	The On Overdue configuration is Grey Weight, and Sensitivity Test is Overdue.	Run Sensitivity Test.
Sensitivity Overdue. Scale Disabled. Reset Required.	4095	2	Y	N	The On Overdue configuration is No Weight, and Sensitivity Test is Overdue.	Run Sensitivity Test.

Message (TFT Display)	Alarm Code	Namur Level	Error Log	I/O	Description	Action
Repeatability Overdue. Please Run Repeatability Test	4078	2	Y	N	The On Overdue configuration is Grey Weight, and Repeatability Test is Overdue.	Run Repeatability Test
Repeatability Overdue. Scale Disabled. Reset Required.	4079	2	Y	N	The On Overdue configuration is Grey Weight, and Repeatability Test is Overdue.	Run Repeatability Test
1Points Overdue. Please Run 1-Point Test	4080	2	Y	N	The On Overdue configuration is Grey Weight, and 1-Point Test is Overdue.	Run 1Points Test.
1-Point Overdue. Scale Disabled. Reset Required.	4081	2	Y	N	The On Overdue configuration is No Weight, and 1-Point Test is Overdue.	Run 1Points Test.
WalkTest Overdue. Please Run Walk-Test	4082	2	Y	N	The On Overdue configuration is Grey Weight, and Walk Test is Overdue,	Run Walk-Test.
WalkTest Overdue. Scale Disabled. Reset Required.	4083	2	Y	N	The On Overdue configuration is No Weight, and Walk Test is Overdue.	Run Walk-Test.
CustomEvent Overdue. Please Run CustomEvent Test	4084	2	Y	N	The On Overdue configuration is Grey Weight, and Custom Event Test is Overdue.	Run Custom Test
CustomEvent Overdue. Scale Disabled. Reset Required.	4085	2	Y	N	The On Overdue configuration is No Weight, and Walk Test is Overdue.	Run Custom Test
Eccentricity Overdue. Please Run Eccentricity Test	4086	2	Y	N	The On Overdue configuration is Grey Weight, and Walk Test is Overdue.	Run Eccentricity Test.
Eccentricity Overdue. Scale Disabled. Reset Required.	4087	2	Y	N	The On Overdue configuration is No Weight, and Walk Test is Overdue.	Run Eccentricity Test.
Sensitivity is coming Due	4088	2	Y	N	Sensitivity Test exceeds Reminder Date.	Run Sensitivity Test.
Calibration is coming Due	4089	2	Y	N	Calibration Test exceeds Reminder Date.	Run Calibration Test.
Repeatability is coming Due	4090	2	Y	N	Repeatability Test exceeds Reminder Date	Run Repeatability Test.
1-Point is coming Due	4091	2	Y	N	1Points Test exceeds Reminder Date	Run 1Points Test.
Walk-Test is coming Due	4092	2	Y	N	Walk-Test exceeds Reminder Date.	Run Walk-Test.
CustomEvent is coming Due	4093	2	Y	N	CustomEvent exceeds Reminder Date.	Run Custom Test.
Eccentricity is coming Due	4094	2	Y	N	Eccentricity exceeds Reminder Date.	Run Eccentricity Test.
EEE	91036	0	N	Y	Power up Zero fails.	-

Message (TFT Display)	Alarm Code	Namur Level	Error Log	I/O	Description	Action
COM4 Error	90009	0	Y	Y	<ul style="list-style-type: none"> <li>The setting at Communication &gt; Connections &gt; COM4 is ACM500, and the IND500x does not register communication from the ACM500 when it is powered up.</li> </ul> OR <ul style="list-style-type: none"> <li>Communication is lost between the IND500x and ACM500.</li> </ul>	<ul style="list-style-type: none"> <li>Check the cables connection between IND500x and ACM500.</li> <li>Restart ACM500 first and then IND500x to check the communication.</li> <li>If the communication still fails, check if ACM500 works properly.</li> </ul>
COM5 Error	90010	0	Y	Y	<ul style="list-style-type: none"> <li>The setting at Communication &gt; Connections &gt; COM5 is ACM500, and the IND500x does not register communication from the ACM500 when it is powered up.</li> </ul> OR <ul style="list-style-type: none"> <li>Communication is lost between the IND500x and ACM500.</li> </ul>	<ul style="list-style-type: none"> <li>Check the cables connection between IND500x and ACM500.</li> <li>Restart ACM500 first and then IND500x to check the communication.</li> <li>If the communication still fails, check if ACM500 works properly.</li> </ul>
More than one Local Analog Output Option is installed.	90006	0	Y	N	-	-
More than one PLC Option installed. Only local Slot3 - 4-20 mA is Active.	90007	0	Y	N	-	-
Local Slot4 - 4-20 mA Conflicts With ACM500 Connection.	90008	0	Y	N	-	-
Scale In Expanded Mode	91006	0	N	N	Tare Operation is invalid when Scale is in Expanded Mode (x10 Mode).	-
Zero Failed-Zero Bad	91007	0	N	N	Zero Operation is invalid when Power up zero is not captured yet.	-
Print Not Ready	91008	0	N	N	User triggered Print Key when current Weight < Print Minimum Weight Threshold.	-
Print Failed-No Demand Output	91009	0	N	N	Print Key triggered but there is no Demand Output connection.	-
Print Error	91010	0	N	N	Print Key triggered but there is no Weight Data.	-

Message (TFT Display)	Alarm Code	Namur Level	Error Log	I/O	Description	Action
Scale In Motion	91011	0	N	N	Print Key triggered but Scale is in motion and motion is timeout.	-
Scale Under Zero	91012	0	N	N	Print Key triggered but Scale is Under Zero Blanking.	-
Scale In Expanded Mode	91013	0	N	N	Print Operation is invalid when Scale is in Expanded Mode (x10 Mode).	-
Print Error-No Zero	91014	0	N	N	Print Operation is invalid when Scale is in Expanded Mode (x10 Mode).	-
Printing	91015	0	N	N	In printing	-
Print Failed-Over Capacity	91016	0	N	N	-	-
Control Network OK	91017	0	N	N	-	-
Zero Failed - Unknown	91018	0	N	N	Digital Scale, when Terminal sends a Zero Command to Scale, Digital Scale Return Response "I"	-
Clear Failed - Unknown	91019	0	N	N	Digital Scale, when Terminal sends a Clear Command to Scale, Digital Scale Return Response "I"	-
FACT Cancelled	91021	0	N	N	-	-
FACT Successful	91022	0	N	N	-	-
FACT Failure - Motion	91023	0	N	N	-	-
FACT Failure	91024	0	N	N	-	-
FACT In Progress	91025	0	N	N	-	-
FACT Failed - 3 Consecutive Failed Attempts	91026	0	N	N	-	-
Function Disabled	91027	0	N	N	-	-
No Report Connection	91028	0	N	N	-	-
No Totals Report Connection	91029	0	N	N	-	-
Template parsing fail	91030	0	N	N	-	-
Totals overflow	91031	0	N	N	Totalization Overflow	Reset Totalization
Target Total Overflow	91032	0	N	N	Target Record Totalization Overflow	Reset Target Record Totalization.
Tare Total Overflow	91033	0	N	N	Tare Record Totalization Overflow	Reset Tare Record Totalization.
ID Not Found	91034	0	N	N	Tare Record of this Tare ID is not found.	Select existing Tare ID.
ID Not Found	91035	0	N	N	Target Record of this Tare ID is not found.	Select existing Target ID.
Transferring failed	91001	0	N	N	-	-



## 4.7 Troubleshooting

### 4.7.1 Power Test

If the display is blank or if intermittent problems occur, the condition of the power source should be checked.

- 1 Check the AC power at the APS768x or PSUx source.
- 2 If no AC power is present at the APS768x or PSUx input, let a qualified electrician at the site restore power at the source.
- 3 After power is restored, test the IND500x for correct operation.
- 4 If there is AC voltage present at the source (APS768x or PSUx input), check the output of the APS768x or PSUx and input of the IND500x.
- 5 When measuring the input voltages of the IND500x, make sure that the IND500x is ON and the scale is connected. See the Figure Pin Locations on IND500x and Table Input Voltages IND500x from APS768x / PSUx that follow for pin testing positions and expected voltages.
- 6 If wiring is correct, disconnect the PSUx and measure the voltages of the APS768x or PSUx. See the Table Output Voltages APS768x / PSUx.

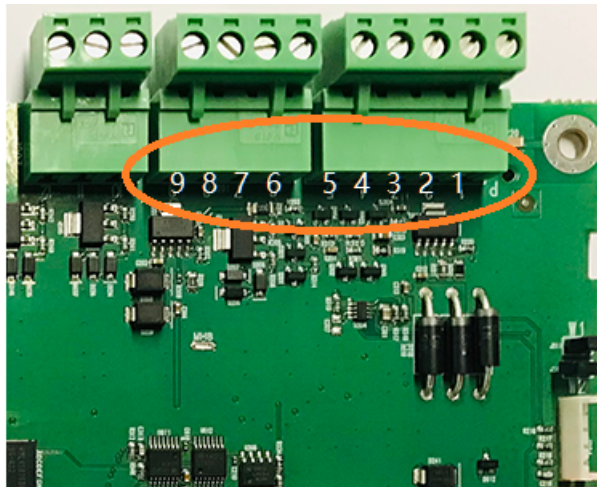

Figure 104: Pin Locations on IND500x

Input Voltages IND500x from APS768x / PSUx			
Measuring Point	Setpoint [V DC] Min	Setpoint [V DC] Max	Remarks
P1 – P2	8.5	10.5	
P3 – P2	3.8	5.9	
P5 – P2	9	12.6	Depends on connected load.
P6 – P7	7.8	8.7	
P8 – P7	10.3	12.6	T-brick is connected.
P9 – P7	5.7	7.15	

Output Voltages APS768x / PSUx		
Measuring Point	Setpoint [V DC] Min	Setpoint [V DC] Max
U1 – GND	7.8	8.7
U2 – GND	11.4	12.6
U3 – GND	6.6	7.15
U4 – GND	9.5	10.5
U5 – GND	4.8	5.9
U6 – GND	11.4	12.6

### 4.7.1.1 Load Cell and IDNet/SICSPro Power

- 1 When measuring the output voltages of a connected analog load cell system or IDNet base, make sure that the IND500x is ON and the scale is correctly connected.
- 2 Refer to the Table Output Voltages for pin testing positions and expected voltages of the analog load cell connection and IDNet / SICSPro connection.

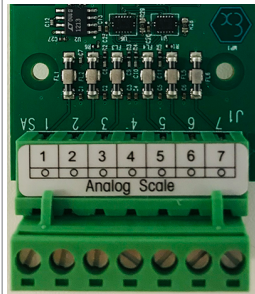
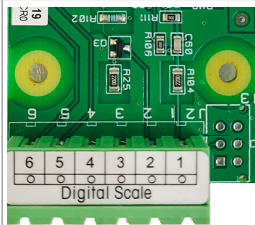
Output Voltages				
Name	Figure	Measuring Point	Setpoint [V DC] Min	Setpoint [V DC] Max
Analog		SA1 – SA7	4.6	5.1
IDNet / SICSPro		J2/6 - J2/4	10.3	12.6
		J2/5 - J2/4	7.8	8.7

### 4.7.2 Battery Test

If setup parameters change uncontrollably or programming is lost, the BRAM battery voltage is to be checked. Battery voltage is tested at the battery assembly on the Main PCB.

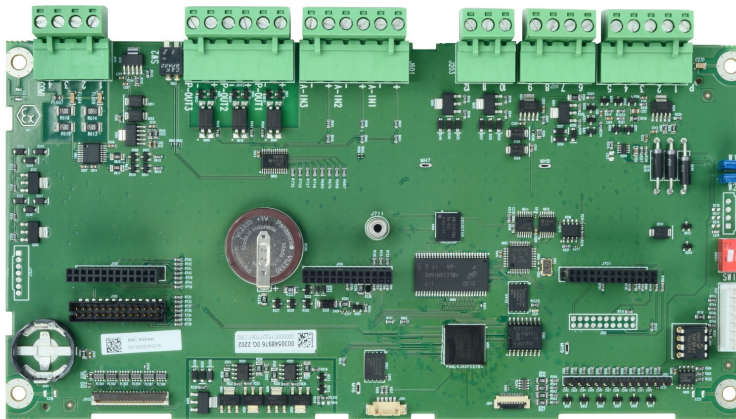



Figure 105: Main PCB

- 1 Disconnect the power.
- 2 Use a Volt-Ohm meter to measure the voltage between the top of the battery (+) and COM1 pin 4 (ground).
  - ➔ The voltage measured should be approximately 3.0 to 3.4 VDC.
- 3 If the measured voltage is below 2.5 VDC, replace the Main PCB.
  - ➔ The battery test is done.

### 4.7.3 Internal Diagnostic Testing

The IND500x provides several internal diagnostic tests that are accessible in setup mode.

- 1 Press the SETUP softkey  to view the setup menu tree.
- 2 Use the DOWN navigation key to scroll down the menu tree to Maintenance.
- 3 Press the RIGHT navigation key to expand the menu tree selections for Maintenance.

- 4 Scroll down and expand the branch Run.
- 5 Scroll down and expand the branch Diagnostics.
  - ➔ The available diagnostic setup screens show.

#### **4.7.3.1 Display Test**

An alternate off/on dot block pattern is shown when accessed. After the alternate off/on cycle, the display will return to the menu tree.

#### **4.7.3.2 Keyboard Test**

Each key that is pressed will be shown on the display for a keyboard testing. When the testing is complete, user can press the EXIT softkey  to return to the menu tree.

#### **4.7.3.3 Scale**

##### **4.7.3.3.1 Load Cell Output**

The current load cell output (active weight) for the scale is shown. This is useful to determine exactly how many counts the analog section is outputting and is not available with IDNet and SICSpro scales.

##### **4.7.3.3.2 Calibration Values**

The current calibration values for the scale are shown. If these values are recorded after a scale calibration, and the Main PCB is replaced in the future, the calibration values can be manually entered here to “transfer” the previous calibration to the new Main PCB. This is not available with IDNet and SICSpro scales.

##### **4.7.3.3.3 Statistics**

The statistical information for the scale such as the total number of weighments, the number of scale overloads, the peak weight weighed on the scale, the total number of zero commands and failed zero commands is shown. These are very helpful when diagnosing scale problems.

#### **4.7.3.4 Discrete I/O Test**

The Discrete I/O Test is described in the chapter Configuration>Maintenance>Run>Diagnostics>[Discrete I/O Test ▶ Page 141].

### **4.7.4 Master Reset**

A hardware master reset is provided that sets all IND500x terminal settings to the factory default settings (refer to Default Settings in Appendix).

The master reset typically is performed under these circumstances:

- When a software configuration problem arises that cannot be resolved without starting from the factory default settings.
- When security is enabled to protect setup, and the password is lost.
- After a firmware upgrade is performed.
- After a hardware key is installed or removed.

#### **Initiate A Master Reset**

- 1 Remove power from the IND500x.
- 2 Note the position of switches SW1-1 and SW1-2.
- 3 Set both switches SW1-1 and SW1-2 to the position ON.
- 4 The position of SW2-1 determines whether metrologically significant EEPROM (scale) data is reset when a master reset is performed. Set SW2-1 to position ON to reset EEPROM data. If SW2-1 is set to OFF, EEPROM data will not be affected by the master reset.
- 5 Apply power to the IND500x. A warning message shows to ask if all values should be reset to factory defaults.
- 6 Press the ENTER key to perform a master reset.
- 7 Remove power from the IND500x.

- 8 Return SW1-1 and SW1-2 (and, if they were changed, SW2-1 and SW2-2) to their original positions, as noted in step 2.
  - 9 Reapply power to the IND500x.
- If a master reset is not desired,
- 1 Do not press the ENTER key when the warning message shows to ask if all values should be reset to factory defaults.
  - 2 Remove power from the IND500x.
  - 3 Reset switches SW1-1 and SW1-2 (and, if they were changed, SW2-1 and SW2-2) to their original positions.
  - 4 Reapply power to the IND500x. The terminal will power up in the normal run state and a master reset is avoided.

## **4.8 External Diagnostics**

### **4.8.1 Web Server**

The IND500x includes a built-in web server utility that provides valuable tools for examining operation of the terminal, its installed options and software. Information available in the Web Server includes:

- System hardware and software configuration
- Resource utilization
- Scale statistics and data

Web Server Help can also be used for the following functions:

- Reading shared data variables, viewed either statically or dynamically
- Writing shared data values
- Remote terminal reset

The Web Server in the IND500x is accessed with a web browser via the Ethernet connection installed in the ACM500. Access to the Terminal is provided by using its IP address. An IP address can be manually assigned, or assigned automatically by the network, depending on how DHCP is configured in setup at Communication > Network > Ethernet. If DHCP client is enabled, once the terminal is connected to the Ethernet, its IP address will appear in the Ethernet configuration screen.

After an IP address for the IND500x is entered or automatically assigned using DHCP, user can record the address and enter it as the URL in the browser.

If the connection is successful, the Web Server home page shows.

#### **4.8.1.1 Home Page**

When the Web Server is first accessed, the Home Page with available options and system information shows.

Note: the Software column in the Device List section is not filled unless the terminal uses an IDNet or a SICSpro scale base.

The screenshot shows the 'IND500X' Home Page. On the left is a navigation menu with icons and labels: Device, Scale, Terminal, Communication, and Maintenance. The main content area is divided into three sections: System Information, Software, and Equipment List. The System Information section contains a table with columns for ID and value. The Software section contains a table with columns for software type and version. The Equipment List section contains a table with columns for Option and value. At the bottom, there is a Device List table with columns for Channel, Name, Software, and Serial Number.

System Information	
Model	IND500x
ID 1	IND500x
ID 2	METTLER TOLEDO
ID 3	

SoftWare	
boot	30708925 1.00.0005
standard	30617749 1.06.0001

Equipment List	
Analog L/C	
Option	
Option	
Option	ACM500
Option	Ethernet&COM
Option	

Device List			
Channel	Name	SoftWare	Serial Number
1	Scale 1		

Figure 106: Home Page

#### 4.8.1.2 Help File

A help file, accessible from each page via the help button  explains the full range of the utility's features. User can refer to this file for a full explanation of each of the data and utilities available on each page.

The figure below shows a portion of the help file.

## IND500X Web Help

### Web Server Options

The IND500X offers the user valuable tools for examining system operation through the web pages listed below. These include web pages for viewing the system configuration and system utilization of resources. Shared data variables can be viewed either statically or dynamically on the Shared Data web page. The Shared Data web page also provides the ability to write values to shared data after a security login. Two web pages present current information about the state and operation of the scale. An IND500X Terminal can also be restarted or reset by an administrator or service technician if the need arises.

- **System Information**
  - **Model and ID**  
Shows the terminal model and serial numbers and the three terminal ID fields (ID1, ID2, and ID3)
  - **Software**  
Lists the boot code and operating software versions of the terminal. If Application Software is installed, that information is also reported.
  - **Equipment List**  
Contains the IND500X Terminal hardware configuration. This list includes all hardware detected except an internal Discrete I/O option is not detectable and will not be shown in the list.
  - **Channel, Name, Software and Serial Number**  
Shows the programmed name for the scale and the serial number of the scale if it has been entered in setup. When a High Precision IDNet base is used, the software version of the base is also displayed (this field is not used with an analog scale).
  
- **Device/Connected Device**
  - **name, Module, and Note**  
Shows the connected device to the terminal.
  
- **Scale / Statistics / Usage**
  - **Usage Time**  
This is the time spent above 1% of the scale capacity threshold, expressed in percent of powered on time.
  - **Usage Cycles / Day**  
This is the average number of load cycles (weight above 1% capacity) per day averaged over the last seven days (zero cycle days are ignored).
  - **Transactions / Day**  
This is the average number of daily print commands for the last seven days. Zero transaction days are ignored.
  - **Total Transactions**  
Total number of scale transactions. This value is reset only during a Master Reset.
  
- **Scale / Statistics / Peak Loading**
  - **Peak Weight**  
The heaviest load that has been applied to the scale since last Master Reset.
  - **Average Peak Load**  
Average of the daily peak loads for the last seven days, in percent of the primary scale capacity.
  
- **Scale / Statistics / Statistics**
  - **Scale Under Range**  
Total number of occurrences where the gross scale weight fell below zero enough to blank the display.
  - **Scale Overloads**  
Total number of occurrences where the gross scale weight exceeded the scale capacity.
  - **Zero Commands**  
Total number of local or remote scale zero commands that were successfully processed.
  - **Zero Command Failures**  
Total number of local or remote scale zero commands that were rejected.
  - **Zero Command Failures (%)**  
Total number of local or remote scale zero commands that were rejected, expressed as a percent of the total number of zero commands.
  
- **Scale / Data / Capacity**
  - **Scale Type**  
The scale type can be either be Analog or IDNet.
  - **Number of Ranges**

Figure 107: Web Help

### 4.8.1.3 Device

The device page shows a list of the devices being connected to the terminal.

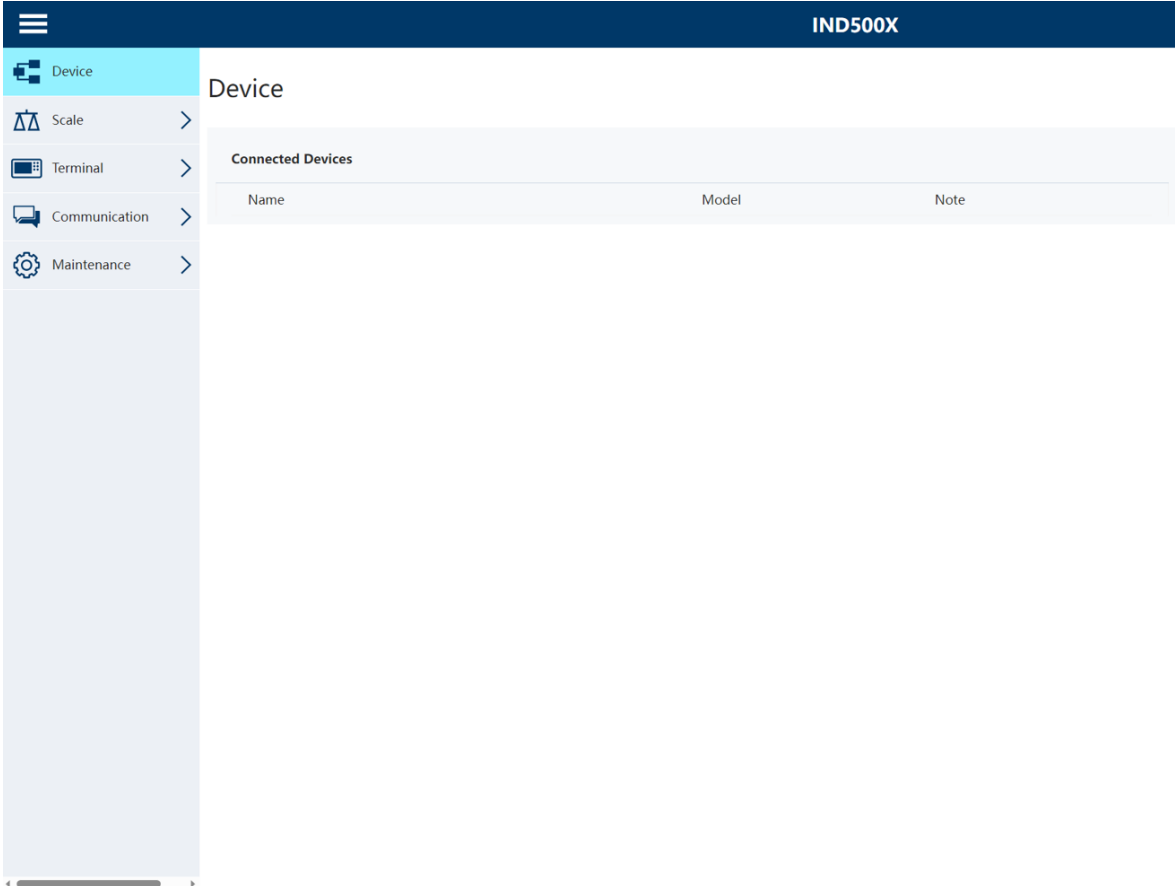

Figure 108: Device

## 4.8.1.4 Scale

### 4.8.1.4.1 Statistics

The scale statistics page shows a variety of data for the scale.

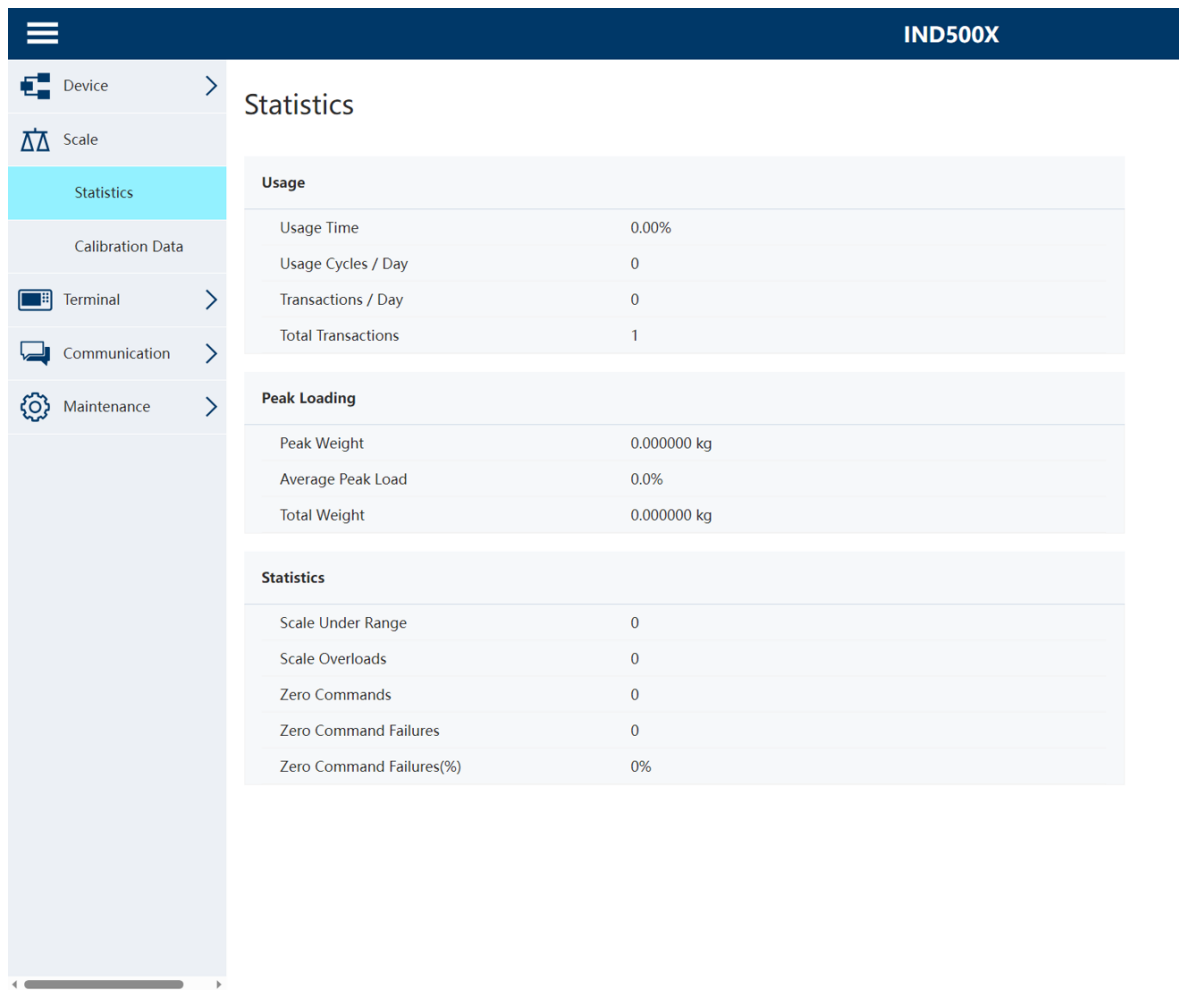

Figure 109: Scale\_Statistics

### 4.8.1.4.2 Calibration Data

The scale calibration data page shows information, including current configuration and calibration values, for the scale.

The signal quality display permits troubleshooting of the connection between the IND500x and load cells. This is a visual representation of the Counts / Display Increment.

- A value less than 20 is considered "poor" and is displayed as a red bar.
- A value between 21 and 40 is considered "good" and is displayed as a yellow bar.
- A value greater than 41 is considered "excellent" and is displayed as a green bar.



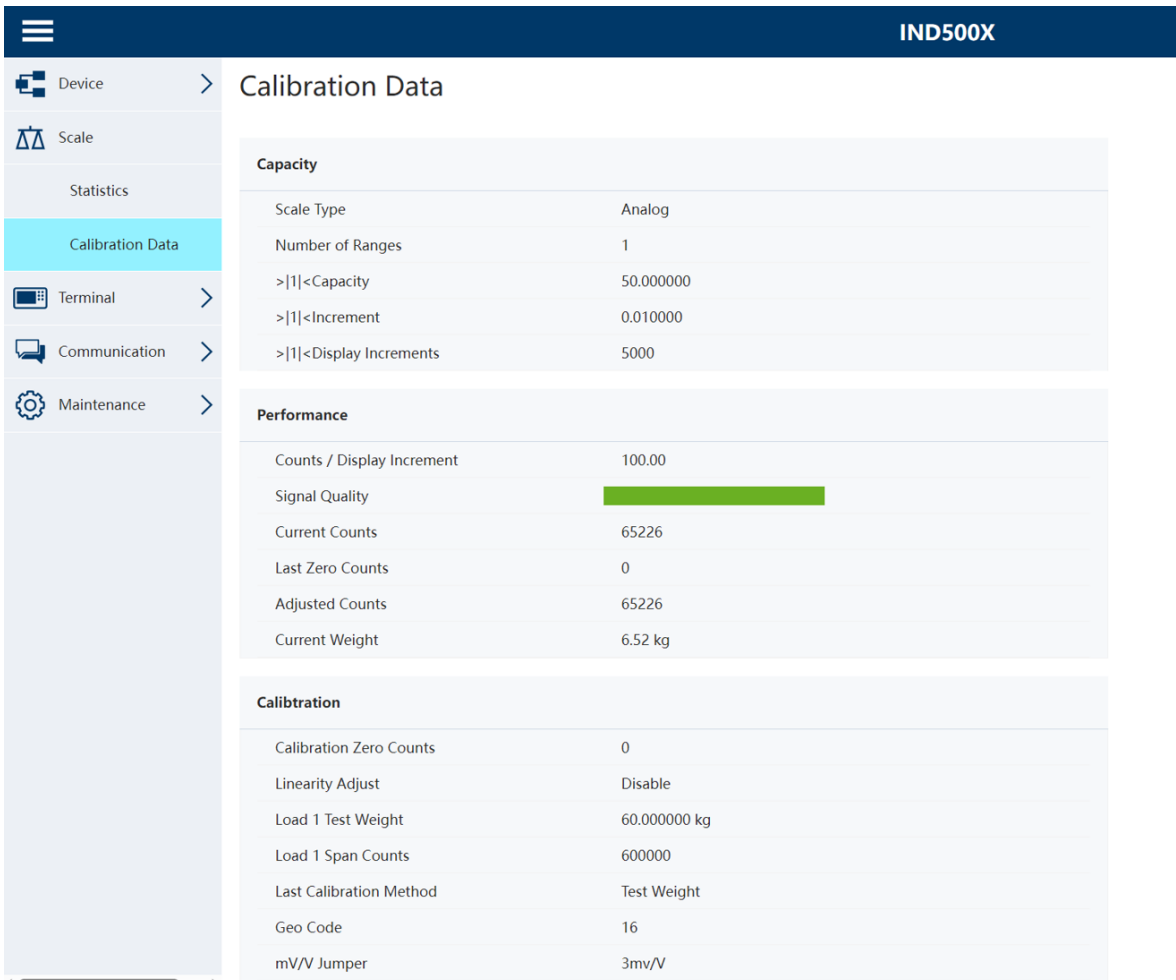

Figure 110: Scale\_Calibration Data

## 4.8.1.5 Terminal

### 4.8.1.5.1 Resource Utilization

The resource utilization page gives a snapshot of the current status of the terminal, including power on time and information about the various types of memory used by the IND500x.

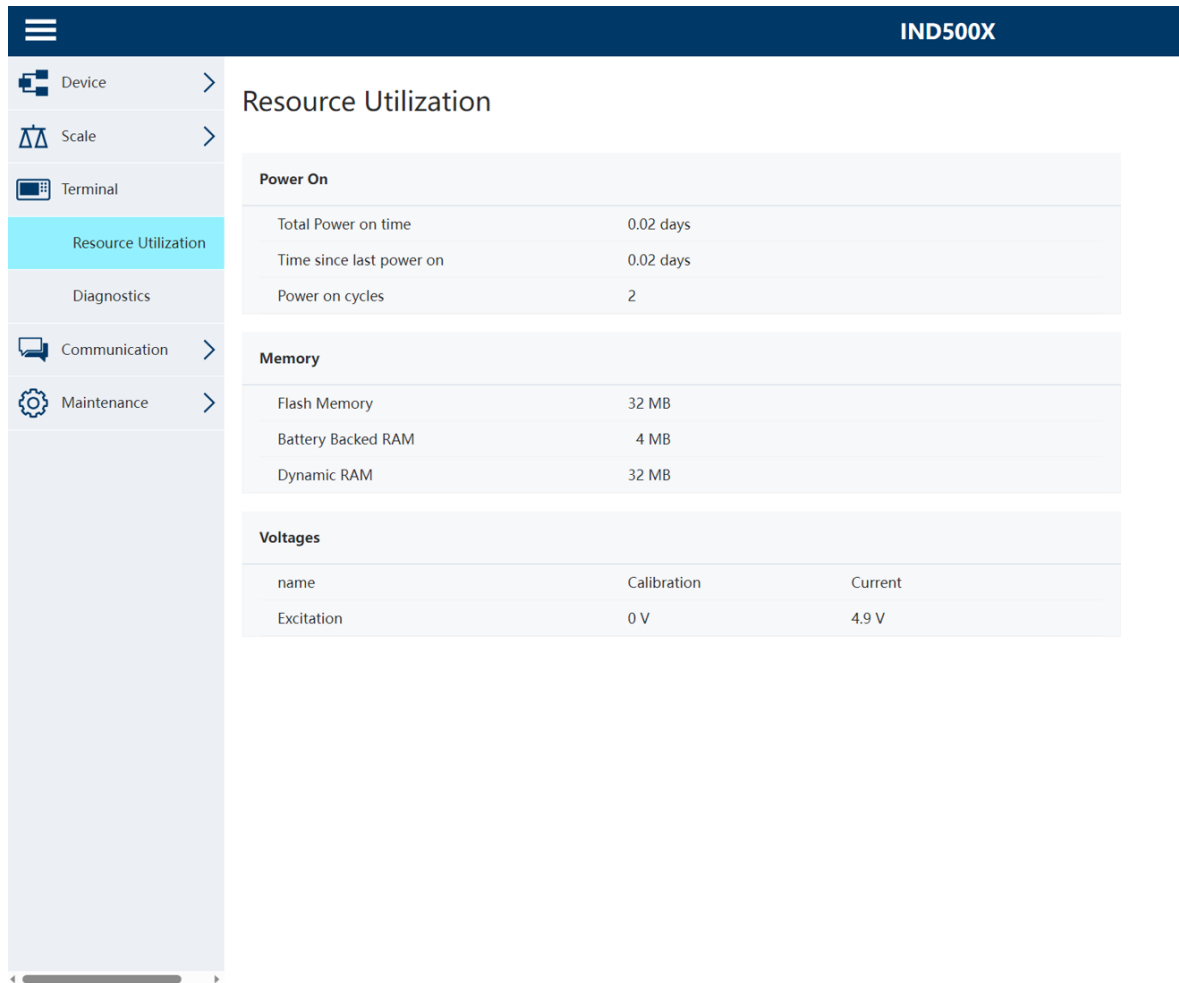

Figure 111: Terminal\_Resource Utilization

### 4.8.1.5.2 Diagnostics

From this screen, the terminal can be restarted (equivalent to cycling power) or reset to factory defaults (except for scale settings, scale calibration settings, tables and log files).

- When a Reset is performed, the Terminal's IP address will default to factory settings.
- If user security is enabled, access to the Terminal>Diagnostics page requires a login at the administrator level. When prompted, user must enter the administrator's user name and password.

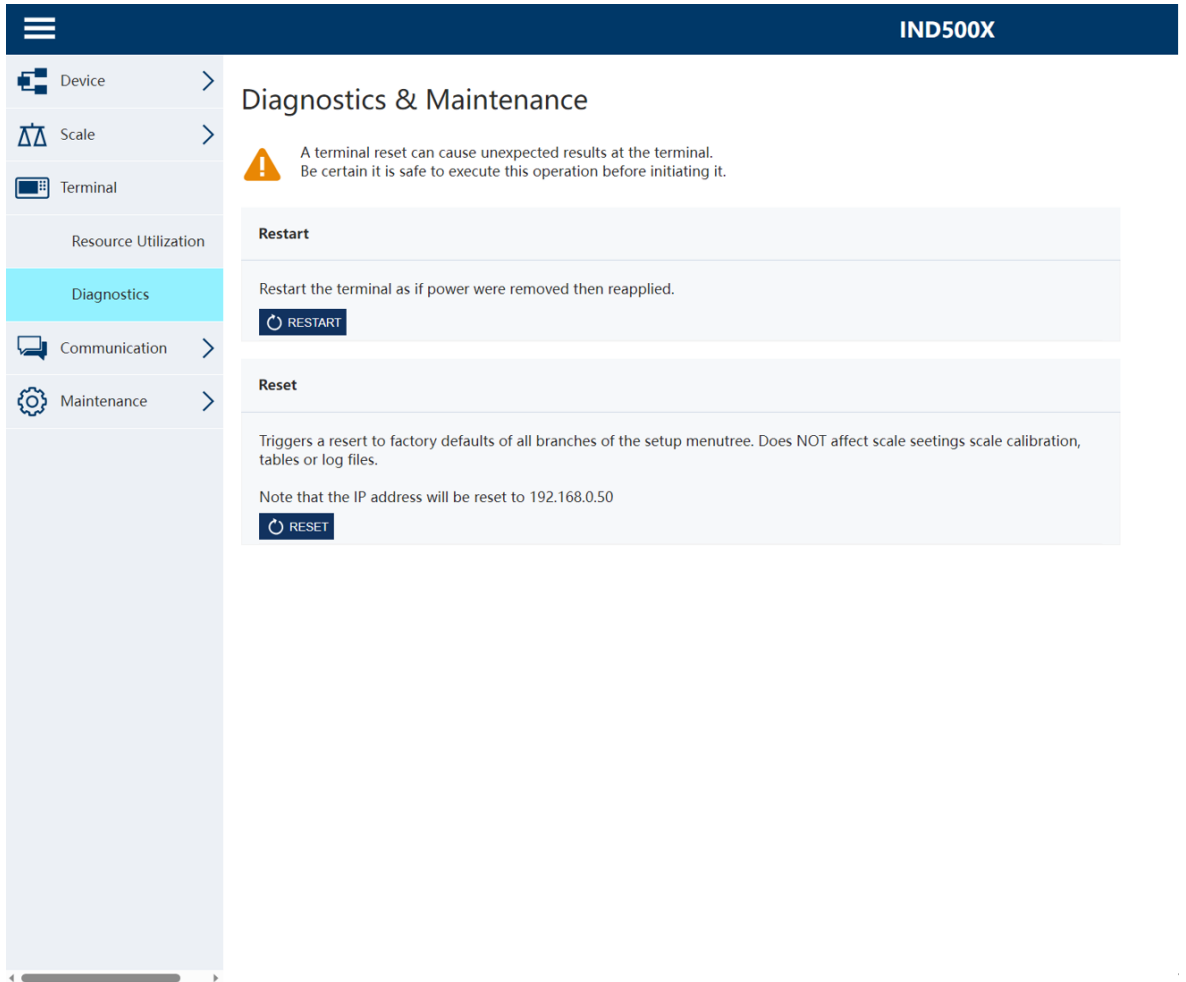

Figure 112: Terminal\_Diagnostics

## 4.8.1.6 Communication

### 4.8.1.6.1 Service Alert

The service alert page shows a list of events for service. The detailed information of each event, including the status, due date, last date, and reminder date, is also shown in this page.

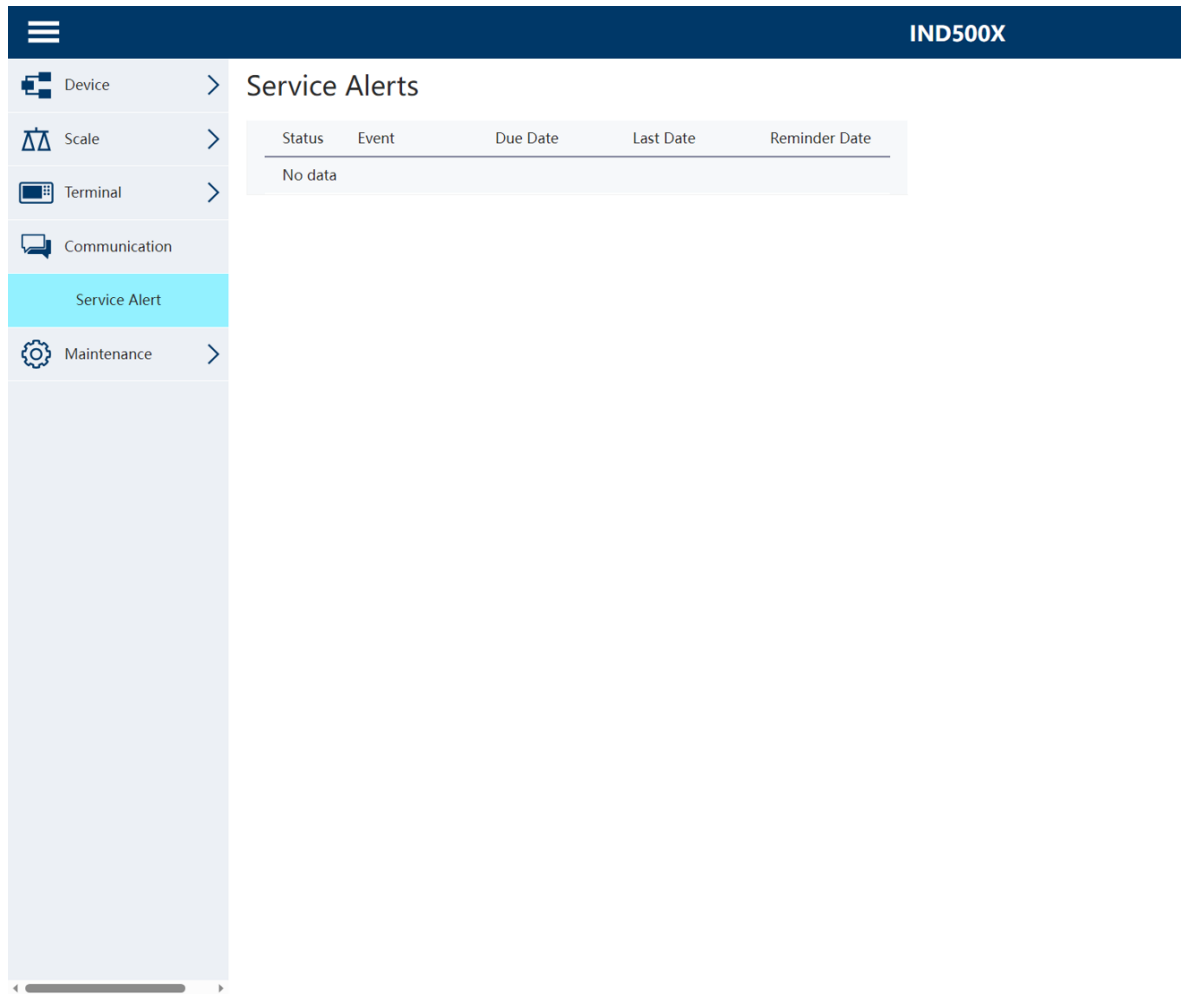

Figure 113: Communication\_Service Alerts

## 4.8.1.7 Maintenance

### 4.8.1.7.1 Write Shared Data

To access the Write Shared Data page, login at the administrator level is required. When prompted, user must enter the administrator's user name and password.

- The Shared Data variable name is entered in the Name column on the left.
- The value of the corresponding variable is written in the Value column on the right.
- Four Shared Data variables can be modified at a time. The Save button is used to save the modification.

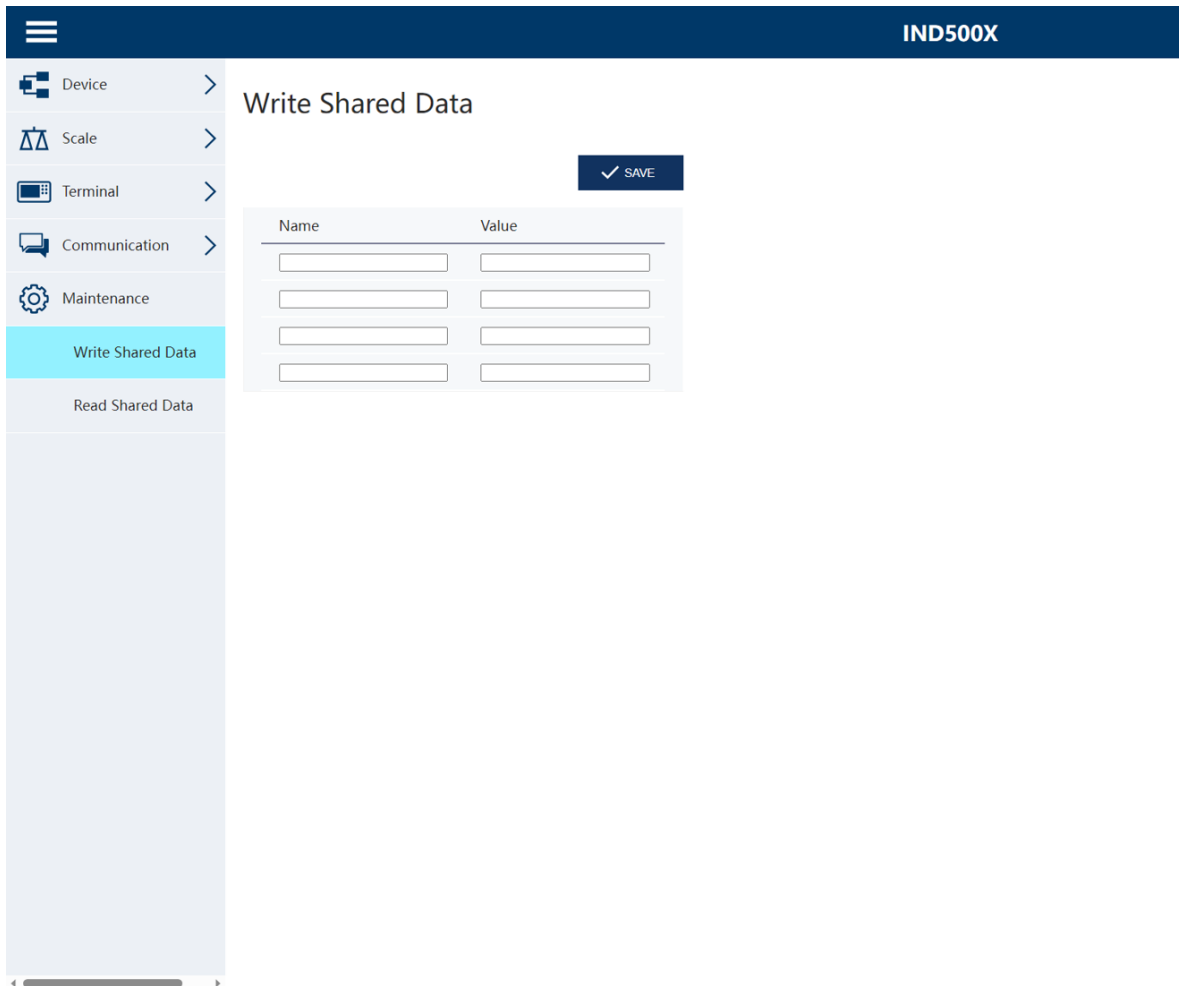

Figure 114: Maintenance\_Write Shared Data

#### 4.8.1.7.2 Read Shared Data

The shared data page allows the user to request a display of current values for up to ten shared data variables at a time. Values are accessed by entering the shared data name in one of the fields on the left. When the Save button is clicked, the Name fields are saved and the Value fields are refreshed. The button is in focus when a new entry is made in a Name field.

To refresh the displayed values without changing any variable names, user can click the Manual Refresh button.

Values may also be refreshed automatically, at one second intervals, by clicking on the Start button.

Once Start is selected, the Stop button is in focus and can be clicked. Note that, as indicated on the page, Auto Refresh must be stopped before new shared data names can be entered.

For a complete list of available shared data names, refer to the IND500x Shared Data Reference (30753836).

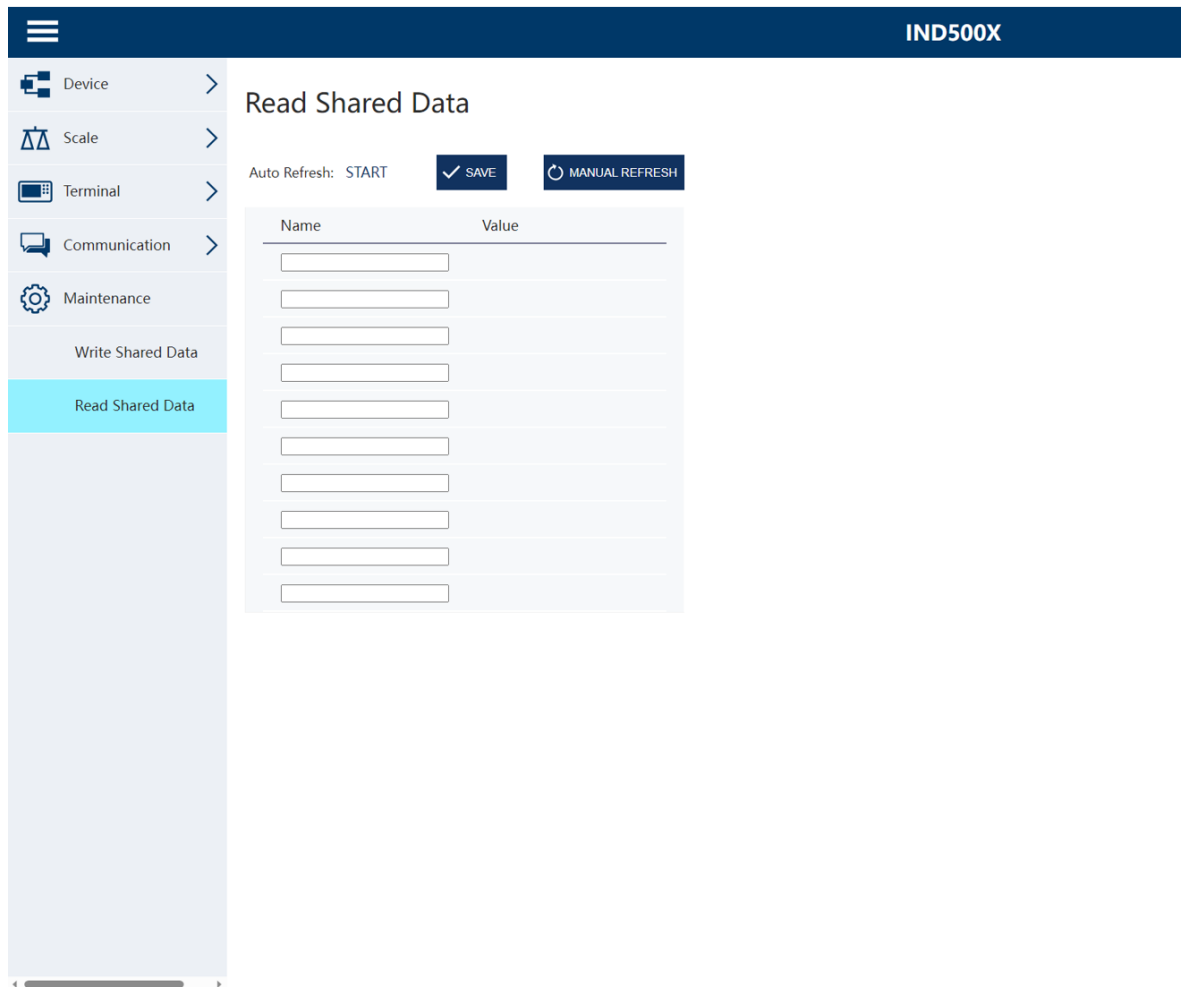

Figure 115: Maintenance\_Read Shared Data

## 5 Appendix

### 5.1 Approvals

This chapter provides approval information for the terminal harsh enclosures. Please read this chapter thoroughly before beginning installation.

Control Drawing #30595335 contains control drawings for the approvals. These documents should also be reviewed before beginning installation.

#### 5.1.1 Testing Standards

The terminal has been tested according to the following standards:

##### 5.1.1.1 CENELEC/ATEX

EN IEC 60079-0:2018	General requirements
EN 60079-11:2012	Protection by Intrinsic Safety "i"
EN 60079-28:2015	Protection using Optical Radiation "op is"
EN 60079-31:2014	Dust ignition protection by Enclosure "t"
EN 60529:1991+ A:2000+ A2:2013	Degrees of protection provided by enclosures (IP code)

##### 5.1.1.2 IECEx

IEC 60079-0: 2017 Edition 7	General Requirements
IEC 60079-11: 2011 Edition 6	Protection by Intrinsic Safety "i"
IEC 60079-28: 2015 Edition 2	Protection using Optical Radiation "op is"
IEC 60079-31: 2013 Edition 2	Dust ignition protection by Enclosure "t"

##### 5.1.1.3 FMus

FM3600 (2018)	Hazardous (Classified) Locations General Requirements
FM3610:2021	Class I, II, and III, Division 1, Hazardous (Classified) Locations Intrinsically Safe Apparatus
FM3810:2021	Electrical Equipment for Measurement, Control and Laboratory Use
ANSI/UL 60079-0:2019	General Requirements
ANSI/UL 60079-11:2014	Protection by Intrinsic Safety "i"
ANSI/UL 60079-28:2017	Protection using Optical Radiation "op is"
ANSI/IEC 60529:2004(R2011)	Degrees of Protection Provided by Enclosures (IP Code)
ANSI/UL 61010-1:2016	Safety Requirements for Electrical Equipment for Measurement, Control, and Laboratory use – Part 1: General Requirements

##### 5.1.1.4 cFM

CAN/CSA-C22.2 No. 60079-0:2019	General Requirements
CAN/CSA-C22.2 No. 60079-11:2014	Protection by Intrinsic Safety "i"
CAN/CSA-C22.2 No. 60079-28:2016	Protection using Optical Radiation "op is"
CAN/CSA-C22.2 No. 61010-1:2012 (R2017)	Safety Requirements for Electrical Equipment
CAN/CSA-C22.2 No. 60529:2016	Degrees of Protection Provided by Enclosures (IP Code)
C22.2 NO. 0.4-17: 2017	Bonding of Electrical Equipment
C22.2 No. 25-17:2017	Enclosures for use in Class II, Groups E, F & G for use in Hazardous Locations

### 5.1.1.5 UKEX Testing Standards

BS EN IEC 60079-0:2018	General Requirements
BS EN 60079-11:2012	Protection by Intrinsic Safety "i"
BS EN 60079-28:2015	Protection using Optical Radiation "op is"
BS EN 60079-31:2014	Dust ignition protection by Enclosure "t"
EN 60529:1991+ A:2000+ A2:2013	Degrees of protection provided by enclosures (IPcode)

## 5.1.2 Understanding Approval Parameters

### 5.1.2.1 Entity Value Calculations

The power input, analog load cell, digital loadcells (IDNet or SICSpro), COM6, discrete inputs, discrete outputs and CL interface of the terminal were reviewed for safety using the entity value method of evaluation. The entity parameters for each of these connections can be found in Control Drawing #30595335. Refer to the approval documentation of the peripheral device to be connected to the terminal for its entity parameters.

The following conditions must be met.

- $U_i$  or  $V_{max} \geq U_o$  or  $V_{oc}$
- $I_i$  or  $I_{max} \geq I_o$  or  $I_{sc}$
- $P_i \geq P_o$  or  $P_t$
- $C_i + C_{cable} \leq C_o$  or  $C_a$
- $L_i + L_{cable} \leq L_o$  or  $L_a$

As an alternative to the direct Inductance calculation, the following inductance to resistance formula may be substituted:

- $L_{a\ max.} / R_a < L_{cable} / R_{cable}$

Where  $L_{cable}$  is the length-based inductivity value and  $R_{cable}$  is the length specific resistance of the cable used.

### 5.1.2.2 Fiber Optic Interface

The fiber optic interface option in the terminal is approved by limiting the maximum power applied to the fiber optic cable. The power is restricted by design to 5mW maximum. This restriction is shown in Control Drawing #30595335.

## 5.1.3 United States Approvals

This section lists approval details for the terminal when installed according to United States requirements. The U.S. safety approvals for the terminal are based upon entity values and fiber optic power restriction. The terminal has been evaluated and approved as:

Intrinsically safe and suitable for use in Class I, Groups A-D; Class II, Groups E-G; Class III; Division 1, Zone 1 & 21 in accordance with entity requirements and METTLER TOLEDO Control Drawing #30595335.

- Intrinsically Safe Class I, II, III, Division 1, Groups A, B, C, D, E, F and G / T4
- Class I, Zone 1 AEx ib [op is Ga] IIC T4 Gb
- Zone 21, AEx ib [op is Da] IIIC T60°C Db  
Ta -10°C...+40°C, Hazardous (Classified) Locations; IP65
- Control Drawing #30595335
- Certificate FM21US0064X

Refer to the certificate or Control Drawing #30595335 for the approval entity values associated with the terminal.

### 5.1.3.1 Special Conditions (FMus)

1. The non-metallic parts (display area) incorporated in the enclosure of this equipment may generate an ignition-capable level of electrostatic charge.
  - The equipment shall not be installed in a location where build-up of electrostatic charge on such surfaces shall occur.
  - The display area of the equipment shall only be cleaned with a damp cloth.
  - The plastic keypad must be replaced when the ESD protection layer is visibly worn.



- Strong solvents are not allowed to be used for cleaning of the plastic keypad.
2. The equipment shall not be used where UV light or radiation may impinge on the enclosure.

#### 5.1.4 European ATEX and UKEX Approvals

Approval details for the terminal when installed according to European requirements are listed in this section. The European safety approvals for the terminal are based upon entity values and fiber optic power restriction. The terminal has been examined by the European notified body FM Approvals Europe Ltd / Dublin, Ireland D02 E440, notified body number 2809; respectively for UK by the FM Approvals Ltd. / Berkshire, SL6 2PJ, United Kingdom, Approved Body number 1725, and has been certified as:

- II 2G Ex ib [op is Ga] IIC T4 Gb
- II 2D Ex ib tb [ib] [op is Da] IIIC T60°C Db
- Ta -10°C...+40°C, IP65
- Certificate FM21ATEX0033X and FM22UKEX0030X

Refer to the certificate or Control Drawing #30595335 for the approval entity values associated with the terminal.

##### 5.1.4.1 Special Conditions (ATEX and UKEX)

1. The non-metallic parts (display area) incorporated in the enclosure of this equipment may generate an ignition-capable level of electrostatic charge.
  - The equipment shall not be installed in a location where build-up of electrostatic charge on such surfaces shall occur.
  - The display area of the equipment shall only be cleaned with a damp cloth.
  - The plastic keypad must be replaced when the ESD protection layer is visibly worn.
  - Strong solvents are not allowed to be used for cleaning of the plastic keypad.
2. The equipment shall not be used where UV light or radiation may impinge on the enclosure.

#### 5.1.5 Canadian Approvals

Approval details for the terminal when installed according to Canadian requirements are listed in this section. The Canadian safety approvals for the terminal are based upon entity values and fiber optic power restriction. The terminal has been tested and certified for use as:

Intrinsically safe (entity) for use in Class I, II, III; Division 1; Groups A, B, C, D, E, F and G; Temperature class T4 Ta=40°C; in accordance with METTLER TOLEDO Control Drawing #30595335, hazardous locations.

- Intrinsically Safe Class I, II, III, Division 1, Groups A, B, C, D, E, F and G / T4
- Class I, Zone 1 Ex ib [op is Ga] IIC T4 Gb
- Zone 21, Ex ib [op is Da] IIIC T60°C Db  
Ta -10°C...+40°C, Hazardous (Classified) Locations; IP65
- Control Drawing #30595335
- Certificate FM21CA0040X

Refer to the certificate or Control Drawing #30595335 in Control Drawings for the approval entity values associated with the terminal.

##### 5.1.5.1 Special Conditions (FMca)

1. The non-metallic parts (display area) incorporated in the enclosure of this equipment may generate an ignition-capable level of electrostatic charge.
  - The equipment shall not be installed in a location where build-up of electrostatic charge on such surfaces shall occur.
  - The display area of the equipment shall only be cleaned with a damp cloth.
  - The plastic keypad must be replaced when the ESD protection layer is visibly worn.
  - Strong solvents are not allowed to be used for cleaning of the plastic keypad.
2. The equipment shall not be used where UV light or radiation may impinge on the enclosure.

## 5.1.6 IECEx Approval

Approval details for the terminal when installed according to IECEx requirements are listed in this section. The IECEx safety approval for the terminal is based upon entity values and fiber optic power restriction. The terminal has been examined by the FM Approvals LLC and has been certified as:

- Ex ib [op is Ga] IIC T4 Gb
- Ex ib tb [ib] [op is Da] IIIC T60°C Db
- Ta -10°C...+40°C, IP65
- Certificate IECEx FMG 21.0022X

Refer to the certificate or Control Drawing #30595335 for the approval entity values associated with the terminal.

### 5.1.6.1 Special Conditions (IECEx)

1. The non-metallic parts (display area) incorporated in the enclosure of this equipment may generate an ignition-capable level of electrostatic charge.
  - The equipment shall not be installed in a location where build-up of electrostatic charge on such surfaces shall occur.
  - The display area of the equipment shall only be cleaned with a damp cloth.
  - The plastic keypad must be replaced when the ESD protection layer is visibly worn.
  - Strong solvents are not allowed to be used for cleaning of the plastic keypad.
2. The equipment shall not be used where UV light or radiation may impinge on the enclosure.

### 5.1.7 FMus, FMc, ATEX, IECEx and UKEX Energy Limitation Parameters

Power Input Terminals					
Terminal	Ui	Ii	Pi	Ci	Li
P1 (J202.1)	12.6V	92mA	1.16W	0.33μF	0
P3 (J202.3)	5.9V	240mA	1.41W	0.22μF	0
P5 (J202.5)	12.6V	92mA	1.16W	0.32μF	0
P6 (J201.1)	8.7V	133mA	1.16W	0.357μF	0.08mH
P8 (J201.3)	12.6V	42mA	530mW	0.142μF	0.08mH
P9 (J201.4)	8.7V	133mA	1.16W	0.22μF	0
P10 (J203.1)	5.9V	338mA	2W	0	0
P12 (J203.3)	12.6V	158mA	2W	0.21μF	0

Common GND connections: P2(J202.2), P4(J202.4), P7(J201.2), P11(J203.2)

Active Inputs, Terminal J601					
Terminal	Uo	Io	Po	Co	Lo
A-IN1+ (J601.1) to A-IN1- (J601.2)	5.88V	2mA	2.94mW	0.1μF	100μH
A-IN2+ (J601.3) to A-IN2- (J601.4)	5.88V	2mA	2.94mW	0.1μF	100μH
A-IN3+ (J601.5) to A-IN3- (J601.6)	5.88V	2mA	2.94mW	0.1μF	100μH

Common GND connections: A-IN\*-

Passive Output, Terminal J602					
Terminal	Ui	Ii	Pi	Ci	Li
P-Out1+ (J602.1) to P-Out1- (J602.2)	15V	40mA	150mW	0	0
P-Out2+ (J602.3) to P-Out2- (J602.4)	15V	40mA	150mW	0	0
P-Out3+ (J602.5) to P-Out3- (J602.6)	15V	40mA	150mW	0	0

COM1 (RS-232 IS), Terminal J605
---------------------------------

Terminal	Ui	Ii	Pi	Ci	Li
COM1.1 (J605.1)	±10V	±100mA	250mW	0	0
COM1.2 (J605.2)	±10V	±100mA	250mW	0	0

Common GND connections: COM1.3(J605.3), COM1.4(J605.4)

<b>COM1 (RS-232 IS), Terminal J605</b>					
Terminal	Uo	Io	Po	Co	Lo
COM1.1 (J605.1)	±5.88V	±19.8mA	29.1mW	100nF	100µH
COM1.2 (J605.2)	±5.88V	±19.8mA	29.1mW	100nF	100µH

Common GND connections: COM1.3(J605.3), COM1.4(J605.4)

<b>Analog Scale Interface Board, Terminal SA1-7</b>					
Terminal	Uo	Io	Po	Co	Lo
SA1-7 (J1)	5.88V	133mA	790mW	200nF	300µH

<b>Digital Interface Board, Terminal J2</b>					
Terminal	Uo	Io	Po	Co	Lo
J2.6	12.6V	42mA	530mW	390nF	950µH
J2.5	8.7V	133mA	1.16W	770nF	250µH
J2.2	5.88V	30mA	45mW	100nF	100µH
J2.1	5.88V	30mA	45mW	100nF	100µH

Common GND connections: J2.3, J2.4

<b>Passive CL Interface Board, Terminal J4</b>					
Terminal	Ui	Ii	Pi	Ci	Li
J4	10V	280mA	400mW	110nF	0

<b>COM6 RS232 IS Interface Board, Terminal J1</b>					
Terminal	Ui	Ii	Pi	Ci	Li
COM6.1 (J1.1)	±10V	±100mA	250mW	0	0µH
COM6.2 (J1.2)	±10V	±100mA	250mW	0	0µH

Common GND connections: COM6.3(J1.3), COM6.4(J1.4)

<b>COM6 RS232 IS Interface Board, Terminal J1</b>					
Terminal	Uo	Io	Po	Co	Lo
COM6.1 (J1.1)	±5.88V	±19.8mA	29.1mW	100nF	100µH
COM6.2 (J1.2)	±5.88V	±19.8mA	29.1mW	100nF	100µH

Common GND connections: COM6.3(J1.3), COM6.4(J1.4)

<b>4-20mA Interface Board, Terminal J4</b>					
Terminal	Ui	Ii	Pi	Ci	Li
I_Out+(J4.1) to I_Out-(J4.3)	12V	115mA	345mW	110nF	0

<b>4-20mA Interface Board, Terminal J4</b>					
--	--	--	--	--	--

Terminal	Uo	Io	Po	Co	Lo
I_Out+(J4.1) to I_Out-(J4.3)	13.65V	115mA	400mW	680nF	400μH

I/O Board Active/Active, Terminal J1					
Terminal	Uo	Io	Po	Co	Lo
A_IN1+ (J1.1A) to A_IN1- (J1.1B)	5.88V	2mA	2.94mW	100nF	100μH
A_IN2+ (J1.2A) to A_IN2- (J1.2B)	5.88V	2mA	2.94mW	100nF	100μH
A_IN3+ (J1.3A) to A_IN3- (J1.3B)	5.88V	2mA	2.94mW	100nF	100μH
A_IN4+ (J1.4A) to A_IN4- (J1.4B)	5.88V	2mA	2.94mW	100nF	100μH
A_IN5+ (J1.5A) to A_IN5- (J1.5B)	5.88V	2mA	2.94mW	100nF	100μH

Common GND connections: A\_IN\*-

I/O Board Active/Active, Terminal J3					
Terminal	Uo	Io	Po	Co	Lo
A_OUT1+ (J3.1A) to A_OUT1- (J3.1B)	12.6V	92mA	610mW	100nF	400μH
A_OUT2+ (J3.2A) to A_OUT2- (J3.2B)	12.6V	92mA	610mW	100nF	400μH
A_OUT3+ (J3.3A) to A_OUT3- (J3.3B)	12.6V	92mA	610mW	100nF	400μH
A_OUT4+ (J3.4A) to A_OUT4- (J3.4B)	12.6V	92mA	610mW	100nF	400μH
A_OUT5+ (J3.5A) to A_OUT5- (J3.5B)	12.6V	92mA	610mW	100nF	400μH
A_OUT6+ (J3.6A) to A_OUT6- (J3.6B)	12.6V	92mA	610mW	100nF	400μH
A_OUT7+ (J3.7A) to A_OUT7- (J3.7B)	12.6V	92mA	610mW	100nF	400μH
A_OUT8+ (J3.8A) to A_OUT8- (J3.8B)	12.6V	92mA	610mW	100nF	400μH

Common GND connections: A\_OUT\*-

I/O Board Active/Passive, Terminal J1					
Terminal	Uo	Io	Po	Co	Lo
A_IN1+ (J1.1A) to A_IN1- (J1.1B)	5.88V	2mA	2.94mW	100nF	100μH
A_IN2+ (J1.2A) to A_IN2- (J1.2B)	5.88V	2mA	2.94mW	100nF	100μH
A_IN3+ (J1.3A) to A_IN3- (J1.3B)	5.88V	2mA	2.94mW	100nF	100μH
A_IN4+ (J1.4A) to A_IN4- (J1.4B)	5.88V	2mA	2.94mW	100nF	100μH
A_IN5+ (J1.5A) to A_IN5- (J1.5B)	5.88V	2mA	2.94mW	100nF	100μH

Common GND connections: A\_IN\*-

I/O Board Active/Passive, Terminal J3					
Terminal	Ui	Ii	Pi	Ci	Li
P_OUT1+ (J3.1A) to P_OUT1- (J3.1B)	15V	40mA	150mW	0	0
P_OUT2+ (J3.2A) to P_OUT2- (J3.2B)	15V	40mA	150mW	0	0
P_OUT3+ (J3.3A) to P_OUT3- (J3.3B)	15V	40mA	150mW	0	0
P_OUT4+ (J3.4A) to P_OUT4- (J3.4B)	15V	40mA	150mW	0	0
P_OUT5+ (J3.5A) to P_OUT5- (J3.5B)	15V	40mA	150mW	0	0
P_OUT6+ (J3.6A) to P_OUT6- (J3.6B)	15V	40mA	150mW	0	0
P_OUT7+ (J3.7A) to P_OUT7- (J3.7B)	15V	40mA	150mW	0	0
P_OUT8+ (J3.8A) to P_OUT8- (J3.8B)	15V	40mA	150mW	0	0

I/O Board Passive/Passive, Terminal J1					
--	--	--	--	--	--

Terminal	Ui	Ii	Pi	Ci	Li
P_IN1+ (J1.1A) to P_IN1- (J1.1B)	30V	50mA	375mW	0	0
P_IN2+ (J1.2A) to P_IN2- (J1.2B)	30V	50mA	375mW	0	0
P_IN3+ (J1.3A) to P_IN3- (J1.3B)	30V	50mA	375mW	0	0
P_IN4+ (J1.4A) to P_IN4- (J1.4B)	30V	50mA	375mW	0	0
P_IN5+ (J1.5A) to P_IN5- (J1.5B)	30V	50mA	375mW	0	0

I/O Board Passive/Passive, Terminal J3					
Terminal	Ui	Ii	Pi	Ci	Li
P_OUT1+ (J3.1A) to P_OUT1- (J3.1B)	15V	40mA	150mW	0	0
P_OUT2+ (J3.2A) to P_OUT2- (J3.2B)	15V	40mA	150mW	0	0
P_OUT3+ (J3.3A) to P_OUT3- (J3.3B)	15V	40mA	150mW	0	0
P_OUT4+ (J3.4A) to P_OUT4- (J3.4B)	15V	40mA	150mW	0	0
P_OUT5+ (J3.5A) to P_OUT5- (J3.5B)	15V	40mA	150mW	0	0
P_OUT6+ (J3.6A) to P_OUT6- (J3.6B)	15V	40mA	150mW	0	0
P_OUT7+ (J3.7A) to P_OUT7- (J3.7B)	15V	40mA	150mW	0	0
P_OUT8+ (J3.8A) to P_OUT8- (J3.8B)	15V	40mA	150mW	0	0

Active Current Loop Board, Terminal COM4 (J4) & COM5 (J3)					
Terminal	Uo	Io	Po	Co	Lo
COM4 (J4)	5.88V	133mA	211mW	600nF	400µH
COM5 (J3)	5.88V	133mA	211mW	600nF	400µH

### FO Board

The continuous light output power at transmission data line is

FO-COM4 Pout < 5mW

FO-COM5 Pout < 5mW

The continuous light input power at receiver data line is

FO-COM4 Pin < 35mW

FO-COM5 Pin < 35mW

### 5.1.8 Manufacturer Information

Manufacturer's name: Mettler-Toledo GmbH

Address: Im Langacher 44, Greifensee, CH-8606, Switzerland

Trademark:



## 5.1.9 Importer Information

Importer's name: Mettler-Toledo Ltd.  
 Address: 64 Boston Road, Beaumont Leys, Leicester, LE4 1AW, United Kingdom

## 5.1.10 Marking Plate Example

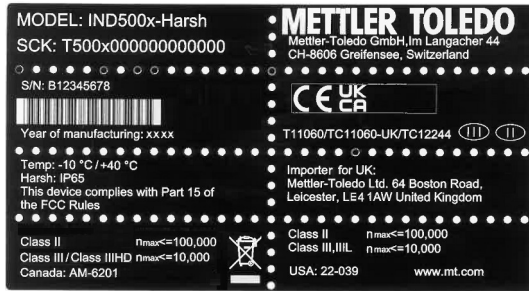

Figure 116: Data Label



Figure 117: Ex Marking Label



Figure 118: Warning Label

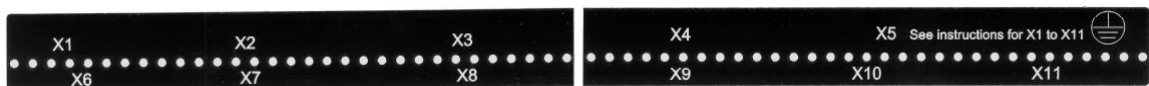

Figure 119: Function Label

## 5.2 Technical Data

### 5.2.1 Control Drawing

## General Notes for IND500x Control Drawing

- IND500x ambient temperature range: -10°C to +40°C
- Special conditions for safe use: refer to IND500x installation manual
- The entity concept allows interconnection of intrinsically safe apparatus and associated apparatus when the following is true:  
 $U_o \leq U_i$  ,  $I_o \leq I_i$  ,  $P_o \leq P_i$  ,  $C_o \geq C_i + C_{cable}$ ;  $L_o \geq L_i + L_{cable}$ .
- Cable shields shall be connected to IND500x by metal cable glands (refer to IND500x installation manual)
- Field cable installation shall be protected from damage and movement.  
Copper wire isolation shall be at least 0.25mm thick per conductor. The actual isolation distance is farther if solid insulation is not considered.
- Connection of equipotential bonding (EB) as per country specific regulations.  
It must be ensured that the housings of all devices are connected to the same potential via the EB terminals. No circulating current may flow via the shielding of the intrinsically safe cables.
- In general, installations shall comply with the relevant country specific regulations.  
Installations in the U.S. should be in accordance with ANSI/ISA RP12.06.01 "Installation of Intrinsically Safe Systems for Hazardous (Classified) Locations" and the latest edition of the National Electrical Code (ANSI/NFPA 70).  
Installation in Canada shall be in accordance with the latest edition of the C22.1 Canadian Electrical Code, Part I.  
Installations in Europe shall comply with the relevant requirements of EN 60079-14 and applicable National regulations.  
Installations for IECEx certification shall be in accordance with IEC 60079-14 and the wiring practices for the country of origin.
- The intrinsically safe apparatus and associated apparatus shall be certified for installations according the country specific requirements.  
For U.S installations it shall be FM approved.
- The intrinsically safe apparatus and associated apparatus manufacturer's installation drawing and instructions shall be followed when installing this equipment
- The equipment connected to associated apparatus (e.g. control room equipment) shall not generate more than 250 Vrms or Vdc, or the marked Um on the associated apparatus, whichever is less.

### NOTICE

THIS ITEM USED IN:  
 AGENCY APPROVED PRODUCT  
 DO NOT CHANGE DOCUMENT  
 WITHOUT APPROPRIATE APPROVAL

<b>METTLER TOLEDO</b>	MTCT	Drawn	Zhang YongJun	2021/11/16	Scale	1:1	
	CN-213125 ChangZhou	Change			Format	mt_A4	
Refer to protection notice ISO 16016 / Schutzvermerk ISO 16016 beachten		Note	-		Replaces	-	
Description	IND500x 控制接线图	ERP NO.	30595335			ERP Rev	A
External Design No.:	External Design Rev.: A	Status:	NOTApproved	Mass:	Units:	mm	1/15

# Power Input connection

Hazardous area (classified)  
Class I, II, III, DIV I or Zone 1 / Zone 21; Indoor location

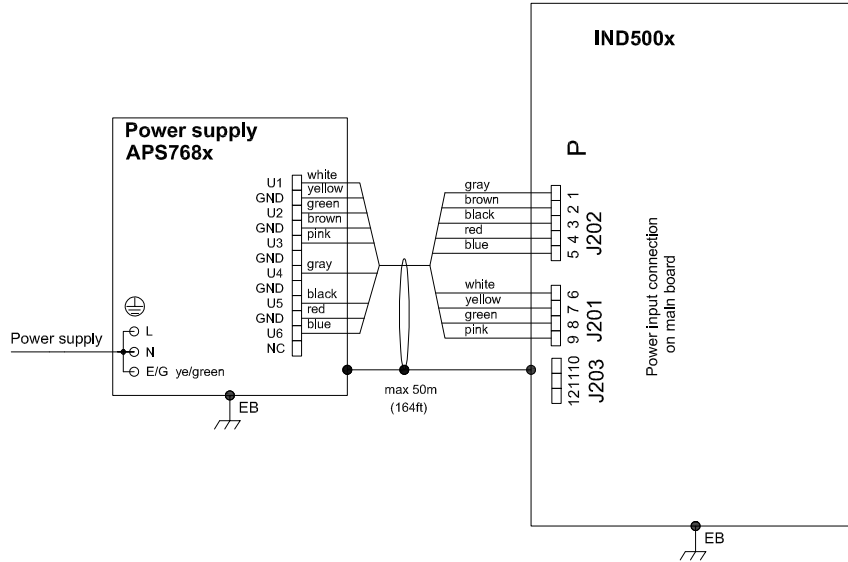

## Entity Parameters:

### Power Input P1-P12

Designator	Ui/V	Ii/mA	Pi/W	Ci/uF	Li/mH
P1(J202.1)	12.6	92	1.16	0.33	0
P3(J202.3)	5.9	240	1.41	0.22	0
P5(J202.5)	12.6	92	1.16	0.32	0
P6(J201.1)	8.7	133	1.16	0.357 **	0.08 **
P8(J201.3)	12.6	42	0.53	0.142 **	0.08 **
P9(J201.4)	8.7	133	1.16	0.22	0
P10(J203.1) *	5.9	338	2	0	0
P12(J203.3) *	12.6	158	2	0.21	0

Common GND connections: P2(J202.2), P4(J202.4), P7(J201.2), P11(J203.2)

\* These Power Inputs are Intended to be used for future use.

\*\* Due to the fact that P6 and P8 are passed through the IND500x to the digital scale, the worst case Ci and Li values and also 20m cable of the connected loadcells or scalebases are already included.

## Application specific notes:

- Also refer to general notes on page 1

## NOTICE

THIS ITEM USED IN:  
 AGENCY APPROVED PRODUCT  
DO NOT CHANGE DOCUMENT  
WITHOUT APPROPRIATE APPROVAL

<b>METTLER TOLEDO</b>	MTCT	Drawn	Zhang YongJun	2021/11/16	Scale	1:1		
	CN-213125 ChangZhou	Change			Format	mt_A4		
Refer to protection notice ISO 16016 / Schutzvermerk ISO 16016 beachten		Note	-		Replaces			-
Description IND500x 控制接线图		ERP NO.			ERP Rev			
<b>Control Drawing IND500x</b>		<b>30595335</b>			<b>A</b>			
External Design No.:	External Design Rev.: A	Status:	NOT Approved	Mass:	Units:	mm	2/15	



# Analog Scale Interface connection

Hazardous area (classified)  
Class I, II, III, DIV I or Zone 1 / Zone 21; Indoor location

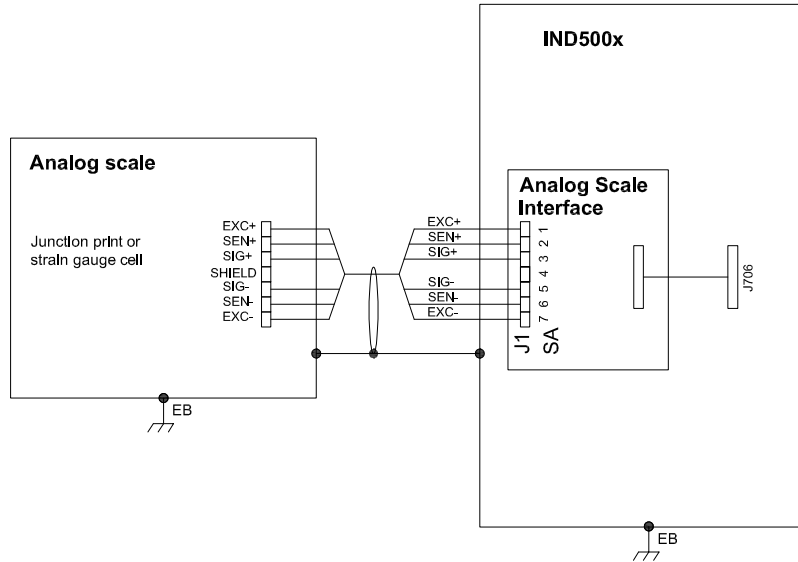

## Entity Parameters:

### Analog Scale Interface

Designator	Uo/V	Io/mA	Po/W	Co/uF	Lo/mH
SA1-7(J1)	5.88	133	0.79	0.2	0.3

## Application specific notes:

- analog scale connection:  
ensure  $U_o \leq U_i$ ,  $I_o \leq I_i$ ,  $P_o \leq P_i$ ,  $C_o \geq C_i + C_{cable}$ ,  $L_o \geq L_i + L_{cable}$ .  
If cable parameters are unknown, use  $C_{cable} = 200\text{pF/m}$  and  $L_{cable} = 1\mu\text{H/m}$
- Also refer to general notes on page 1

## NOTICE

THIS ITEM USED IN:  
 AGENCY APPROVED PRODUCT  
DO NOT CHANGE DOCUMENT  
WITHOUT APPROPRIATE APPROVAL

<b>METTLER TOLEDO</b>	MTCT	Drawn	Zhang YongJun	2021/11/16	Scale	1:1		
	CN-213125 ChangZhou	Change			Format	mt_A4		
Refer to protection notice ISO 16016 / Schutzvermerk ISO 16016 beachten		Note	-		Replaces			-
Description IND500x 控制接线图		ERP NO.				ERP Rev		
<b>Control Drawing IND500x</b>		<b>30595335</b>				<b>A</b>		
External Design No.:	External Design Rev.: A	Status:	NOTApproved	Mass:	Units:	mm	3/15	

# Digital Interface connection

Hazardous area (classified)  
Class I, II, III, DIV I or Zone 1 / Zone 21; Indoor location

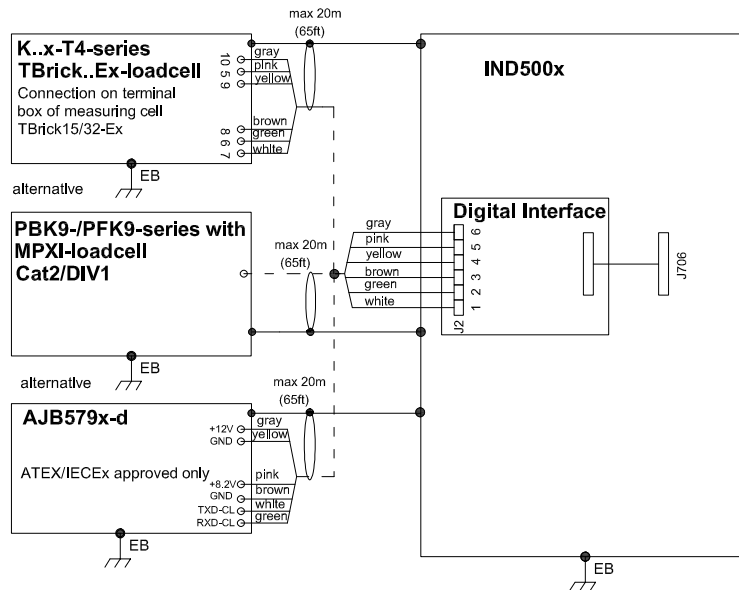

## Entity Parameters:

### Digital Interface

Designator	Uo/V	Io/mA	Po/W	Co/uF	Lo/mH
J2.6(J2.6)	12.6	42	0.53	0.39 see remarks	0.95 see remarks
J2.5(J2.5)	8.7	133	1.16	0.77 see remarks	0.25 see remarks
J2.2(J2.2)	5.88	30	0.045	0.1	0.1
J2.1(J2.1)	5.88	30	0.045	0.1	0.1

GND connections: J2.3(J2.3), J2.4(J2.4)

## Remarks:

- Listed values are based on APS768x power supply and a 50m power supply cable.
- If another power supply is used, follow the description and formulas below:  
The J2.6(J2.6) and J2.5(J2.5) circuits are derived from power input line P8(J201.3) and P6(J201.1) of main board and are passed through the IND500x. Therefore the Co and Lo values correspond to the Co and Lo values of the corresponding connected power supply lines reduced by the internal C and L values and the externally connected power supply cable C and L values of IND500x:

$$Co\_IND500x = Co\_ps - C\_ps\_cable - C\_internal$$

$$Lo\_IND500x = Lo\_ps - L\_ps\_cable - L\_internal$$

- If cable parameters are unknown, use  $C_{cable} = 200pF/m$  and  $L_{cable} = 1\mu H/m$

## Application specific notes:

- Also refer to general notes on page 1

## NOTICE

THIS ITEM USED IN:  
 AGENCY APPROVED PRODUCT  
DO NOT CHANGE DOCUMENT  
WITHOUT APPROPRIATE APPROVAL

<b>METTLER TOLEDO</b>	MTCT	Drawn	Zhang YongJun	2021/11/16	Scale	1:1		
	CN-213125 ChangZhou	Change			Format	mt_A4		
Refer to protection notice ISO 16016 / Schutzvermerk ISO 16016 beachten		Note	-		Replaces			-
Description IND500x 控制接线图		ERP NO.			ERP Rev			
<b>Control Drawing IND500x</b>		<b>30595335</b>			<b>A</b>			
External Design No.:	External Design Rev.: A	Status:	NOTApproved	Mass:	Units:	mm	4/15	

# RS232 IS connection

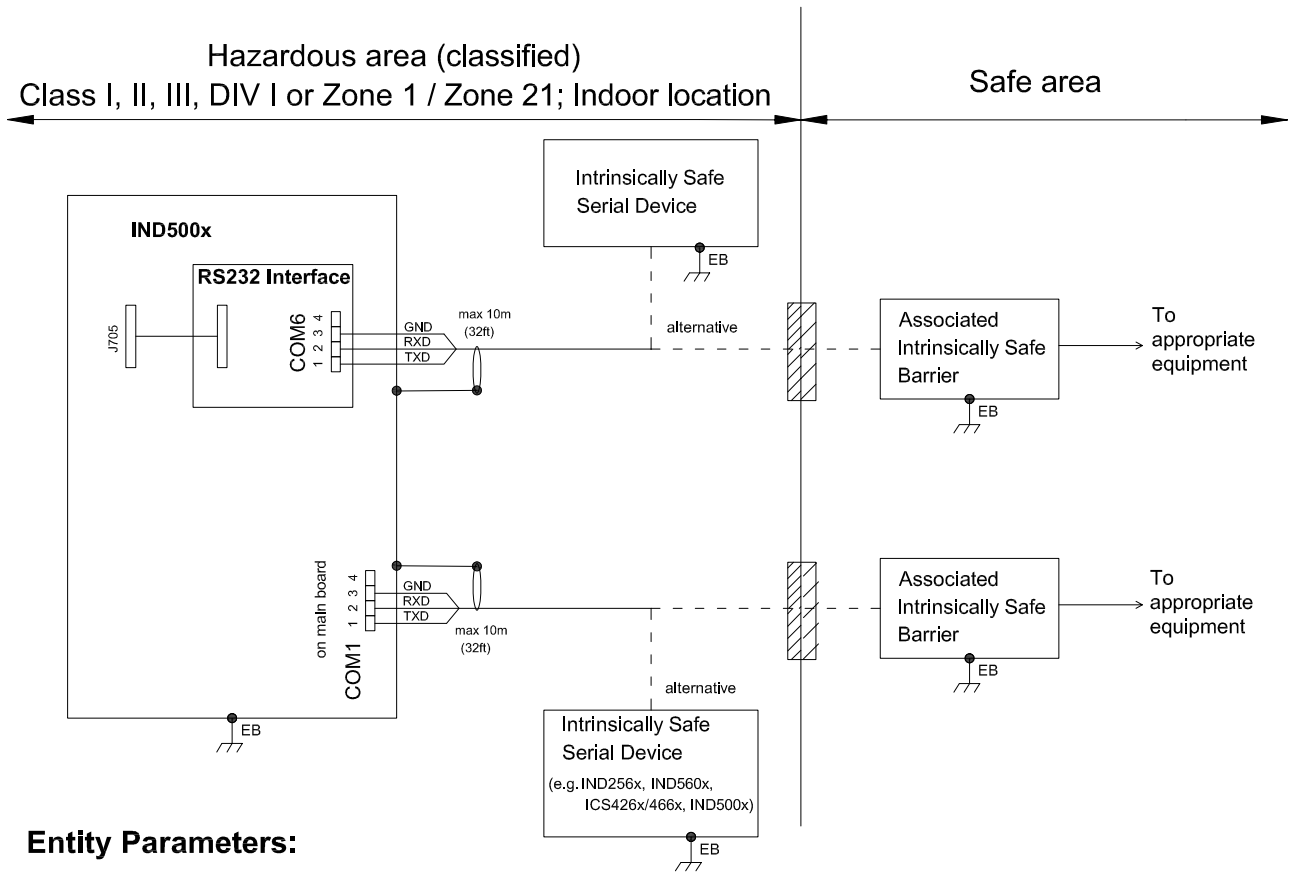

## Entity Parameters:

### COM1 (RS232 IS)

Designator	Ui/V	Ii/mA	Pi/mW	Ci/nF	Li/uH
COM1.1 (J605.1)	±10	±100	250	0	0
COM1.2 (J605.2)	±10	±100	250	0	0

Common GND connections: COM1.3 (J605.3); COM1.4 (J605.4)

Designator	Uo/V	Io/mA	Po/mW	Co/nF	Lo/uH
COM1.1 (J605.1)	±5.88	±19.8	29.1	100	100
COM1.2 (J605.2)	±5.88	±19.8	29.1	100	100

Common GND connections: COM1.3 (J605.3); COM1.4 (J605.4)

### COM6 (RS232 IS)

Designator	Ui/V	Ii/mA	Pi/mW	Ci/nF	Li/uH
COM6.1 (J1.1)	±10	±100	250	0	0
COM6.2 (J1.2)	±10	±100	250	0	0

Common GND connections: COM6.3 (J1.3); COM6.4 (J1.4)

Designator	Uo/V	Io/mA	Po/mW	Co/nF	Lo/uH
COM6.1 (J1.1)	±5.88	±19.8	29.1	100	100
COM6.2 (J1.2)	±5.88	±19.8	29.1	100	100

Common GND connections: COM6.3 (J1.3); COM6.4 (J1.4)

## Application specific notes:

- Install cable seal between differently rated areas per country-specific regulations
- Also refer to general notes on page 1

## NOTICE

THIS ITEM USED IN:  
 AGENCY APPROVED PRODUCT  
 DO NOT CHANGE DOCUMENT  
 WITHOUT APPROPRIATE APPROVAL

**METTLER TOLEDO**

MTCT  
CN-213125 ChangZhou

Drawn Zhang YongJun 2021/11/16 Scale 1:1

Change - Format mt\_A4

Refer to protection notice ISO 16016 / Schutzvermerk ISO 16016 beachten

Note - Replaces -

Description IND500x 控制接线图

ERP NO.

ERP Rev

**Control Drawing IND500x**

**30595335**

**A**

External Design No.: External Design Rev.: A

Status: NOT Approved Mass: Units: mm 5/15

# 4-20mA Interface connection

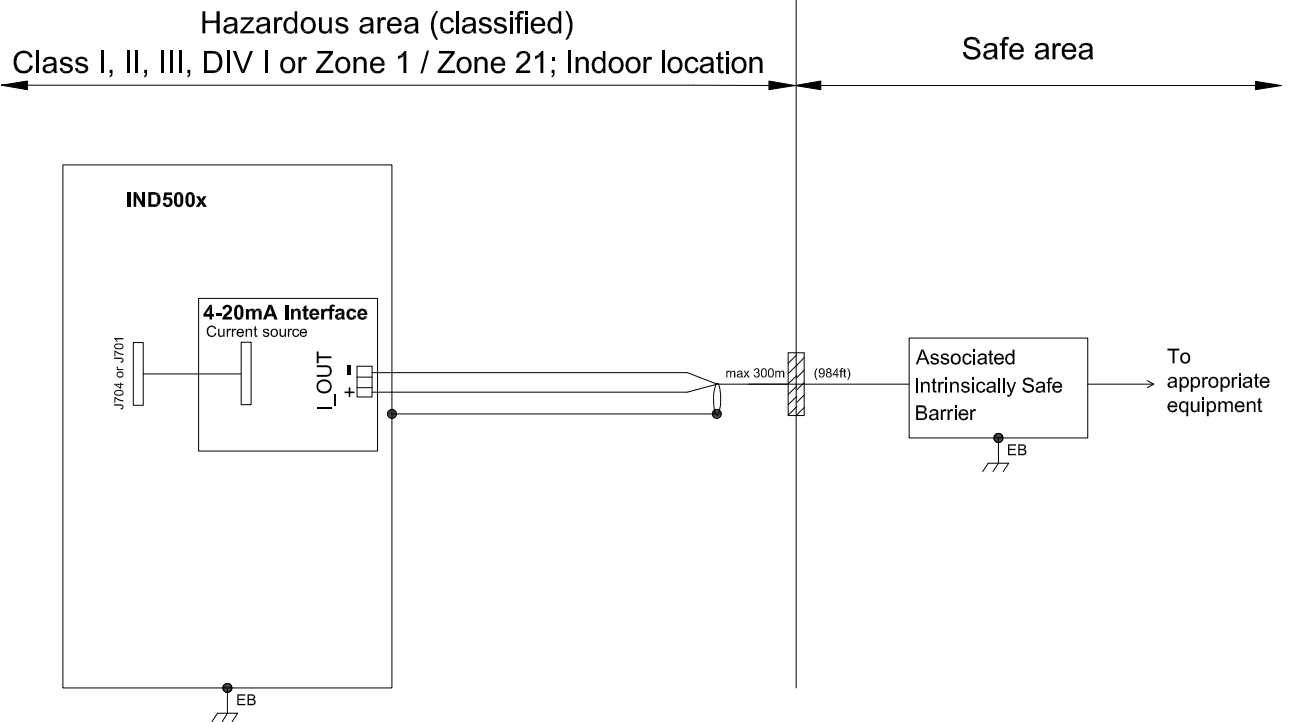

## Entity Parameters:

### 4-20mA Interface

Designator	Uo/V	Io/mA	Po/mW	Co/nF	Lo/uH
I_OUT+ (J4.1) to I_OUT- (J4.3)	13.65	115	400	680	400
Designator	Ui/V	Ii/mA	Pi/mW	Ci/nF	Li/uH
I_OUT+ (J4.1) to I_OUT- (J4.3)	12	115	345	110	0

## Application specific notes:

- Install cable seal between differently rated areas per country-specific regulations
- Also refer to general notes on page 1

## NOTICE

THIS ITEM USED IN:  
 AGENCY APPROVED PRODUCT  
 DO NOT CHANGE DOCUMENT  
 WITHOUT APPROPRIATE APPROVAL

<b>METTLER TOLEDO</b>	MTCT	Drawn	Zhang YongJun	2021/11/16	Scale	1:1		
	CN-213125 ChangZhou	Change			Format	mt_A4		
Refer to protection notice ISO 16016 / Schutzvermerk ISO 16016 beachten		Note	-		Replaces			-
Description IND500x 控制接线图		ERP NO.				ERP Rev		
<b>Control Drawing IND500x</b>		<b>30595335</b>				<b>A</b>		
External Design No.:		External Design Rev.: A		Status:NOTApproved	Mass:	Units:mm	6/15	

# Discrete I/O connection

CASE 1: main board I/O + IO Board A/P

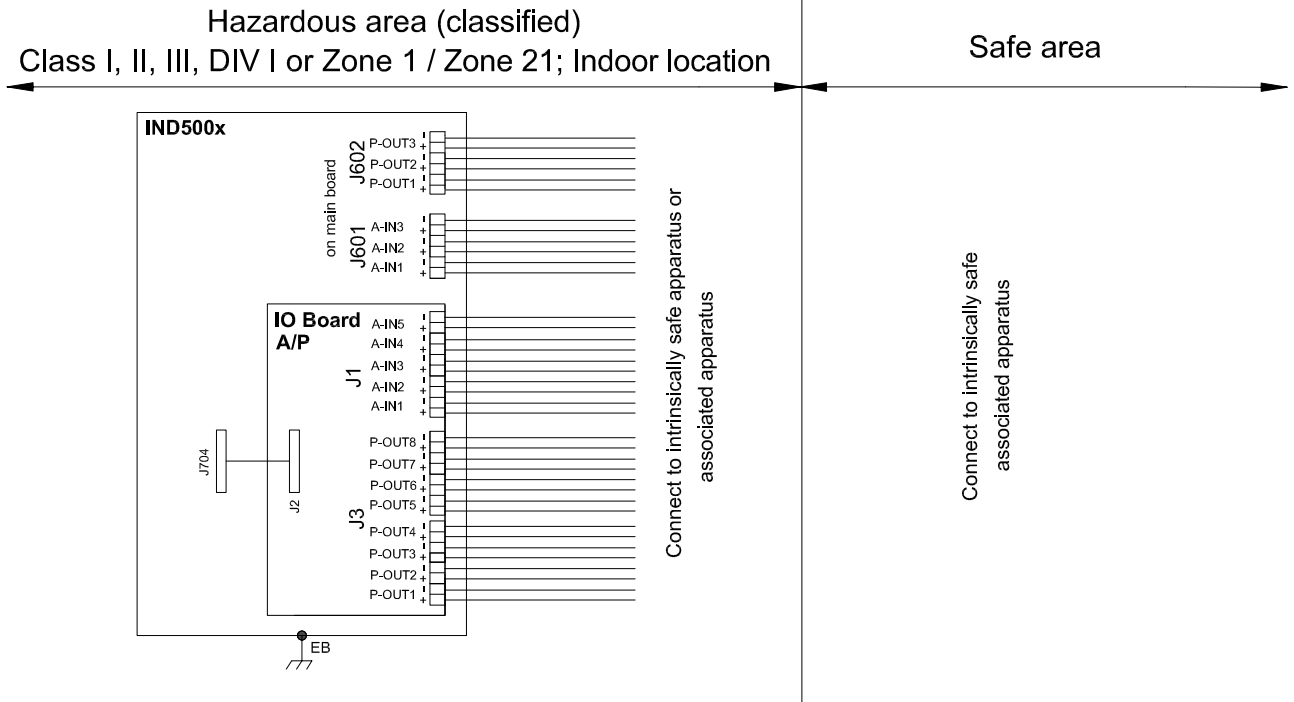

## Entity Parameters:

### Main Board Active Inputs:

Designator	Uo/V	Io/mA	Po/mW	Co/nF	Lo/uH
A-IN1+(J601.1)---A-IN3+(J601.5)	5.88	2	2.94	100	100

Common GND connections: A-IN\*:- J601.2, J601.4, J601.6

### Main Board Passive Outputs:

Designator	Ui/V	Ii/mA	Pi/mW	Ci/nF	Li/uH
P-OUT1+(J602.1) to P-OUT1-(J602.2)	15	40	150	0	0
P-OUT2+(J602.3) to P-OUT2-(J602.4)	15	40	150	0	0
P-OUT3+(J602.5) to P-OUT3-(J602.6)	15	40	150	0	0

### IO Board A/P Active Inputs:

Designator	Uo/V	Io/mA	Po/mW	Co/nF	Lo/uH
A-IN1+(J1.1A)---A-IN5+(J1.5A)	5.88	2	2.94	100	100

Common GND connections: A-IN\*:- J1.1B, J1.2B, J1.3B, J1.4B, J1.5B

### IO Board A/P Passive Outputs:

Designator	Ui/V	Ii/mA	Pi/mW	Ci/nF	Li/uH
P_OUT1+(J3.1A)---P_OUT8+(J3.8A)	15	40	150	0	0

P\_OUT\*+(J3.\*A) refers separately to P\_OUT\*-(J3.\*B)

## Application specific notes:

- Install cable seal between differently rated areas per country-specific regulations
- Discrete I/O active input: connection to simple apparatus (e.g. operator switches) according ATEX/IECEx regulations respectively country specific guidelines.  
For US: NEC (NFPA70), section 504.2 and 504.4
- Also refer to general notes on page 1

## NOTICE

THIS ITEM USED IN:  
 AGENCY APPROVED PRODUCT  
 DO NOT CHANGE DOCUMENT  
 WITHOUT APPROPRIATE APPROVAL

**METTLER TOLEDO**

MTCT  
CN-213125 ChangZhou

Drawn Zhang YongJun 2021/11/16 Scale 1:1

Change - Format mt\_A4

Refer to protection notice ISO 16016 / Schutzvermerk ISO 16016 beachten

Note - Replaces -

Description IND500x 控制接线图

ERP NO.

ERP Rev

**Control Drawing IND500x**

**30595335**

**A**

External Design No.:

External Design Rev.: A

Status: NOT Approved Mass:

Units: mm

7/15

# Discrete I/O connection

CASE 2: main board I/O + IO Board P/P

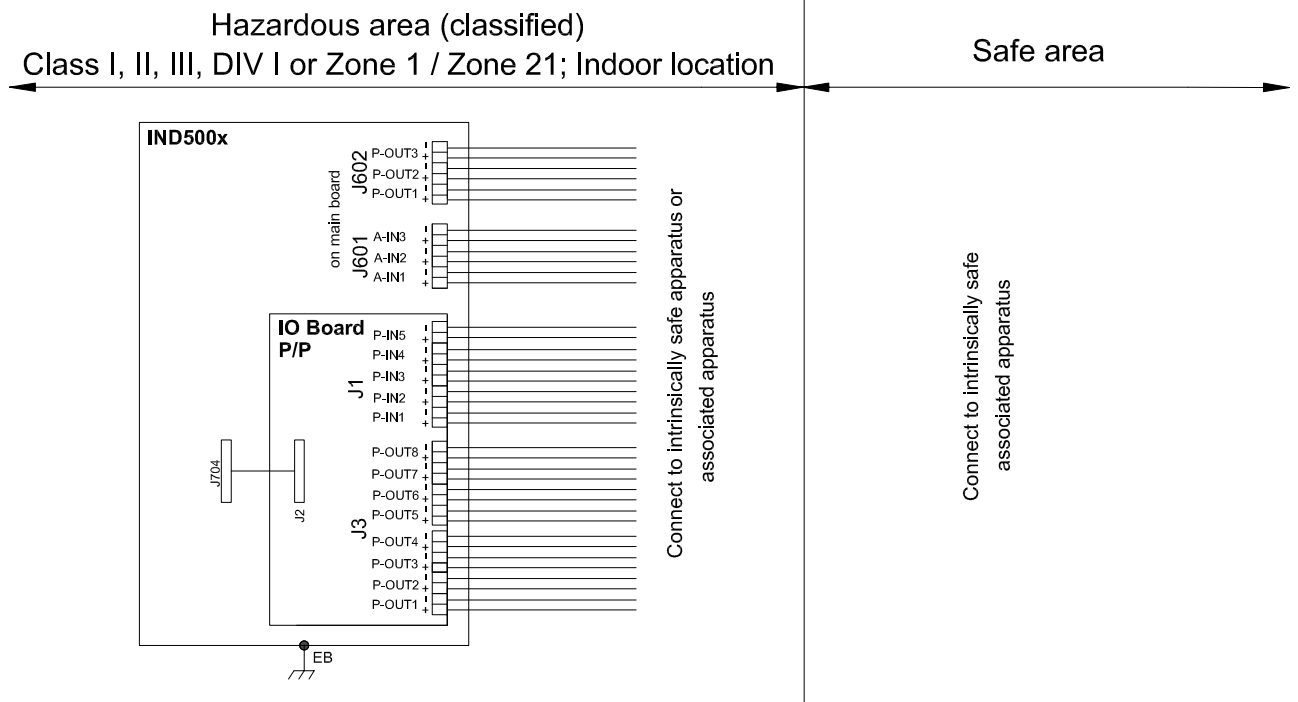

## Entity Parameters:

### Main Board Active Inputs:

Designator	Uo/V	Io/mA	Po/mW	Co/nF	Lo/uH
A-IN1+(J601.1)---A-IN3+(J601.5)	5.88	2	2.94	100	100

Common GND connections: A-IN\*--: J601.2, J601.4, J601.6

### Main Board Passive Outputs:

Designator	Ui/V	Ii/mA	Pi/mW	Ci/nF	Li/uH
P-OUT1+(J602.1) to P-OUT1-(J602.2)	15	40	150	0	0
P-OUT2+(J602.3) to P-OUT2-(J602.4)	15	40	150	0	0
P-OUT3+(J602.5) to P-OUT3-(J602.6)	15	40	150	0	0

### IO Board P/P Passive Inputs:

Designator	Ui/V	Ii/mA	Pi/mW	Ci/nF	Li/uH
P-IN1+(J1.1A)---P-IN5+(J1.5A)	30	50	375	0	0

P-IN\*+(J1.\*A) refers separately to P-IN\*-(J1.\*B)

### IO Board P/P Passive Outputs:

Designator	Ui/V	Ii/mA	Pi/mW	Ci/nF	Li/uH
P_OUT1+(J3.1A)---P_OUT8+(J3.8A)	15	40	150	0	0

P\_OUT\*+(J3.\*A) refers separately to P\_OUT\*-(J3.\*B)

## Application specific notes:

- Install cable seal between differently rated areas per country-specific regulations
- Discrete I/O active input: connection to simple apparatus (e.g. operator switches) according ATEX/IECEX regulations respectively country specific guidelines.  
For US: NEC (NFPA70), section 504.2 and 504.4
- Also refer to general notes on page 1

## NOTICE

THIS ITEM USED IN:  
 AGENCY APPROVED PRODUCT  
 DO NOT CHANGE DOCUMENT  
 WITHOUT APPROPRIATE APPROVAL

<b>METTLER TOLEDO</b>	MTCT	Drawn	Zhang YongJun	2021/11/16	Scale	1:1	
	CN-213125 ChangZhou	Change			Format	mt_A4	
Refer to protection notice ISO 16016 / Schutzvermerk ISO 16016 beachten		Note	-		Replaces		-
Description IND500x 控制接线图		ERP NO.	30595335			ERP Rev	A
External Design No.:	External Design Rev.: A	Status:	NOTApproved	Mass:	Units:	mm	8/15

# Discrete I/O connection

CASE 3: main board I/O + IO Board A/A

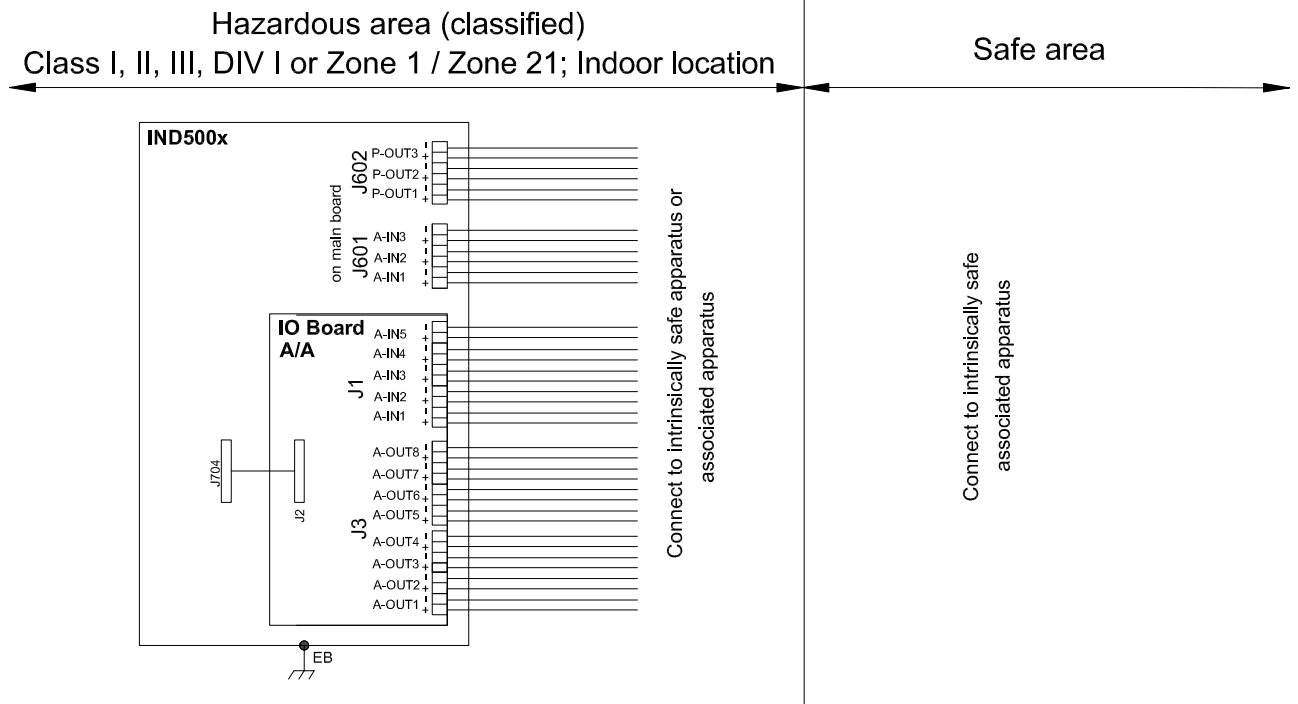

## Entity Parameters:

### Main Board Active Inputs:

Designator	Uo/V	Io/mA	Po/mW	Co/nF	Lo/uH
A-IN1+(J601.1)---A-IN3+(J601.5)	5.88	2	2.94	100	100

Common GND connections: A-IN\*-: J601.2, J601.4, J601.6

### Main Board Passive Outputs:

Designator	Ui/V	Ii/mA	Pi/mW	Ci/nF	Li/uH
P-OUT1+(J602.1) to P-OUT1-(J602.2)	15	40	150	0	0
P-OUT2+(J602.3) to P-OUT2-(J602.4)	15	40	150	0	0
P-OUT3+(J602.5) to P-OUT3-(J602.6)	15	40	150	0	0

### IO Board A/A Active Inputs:

Designator	Uo/V	Io/mA	Po/mW	Co/nF	Lo/uH
A-IN1+(J1.1A)---A-IN5+(J1.5A)	5.88	2	2.94	100	100

Common GND connections: A-IN\*-: J1.1B, J1.2B, J1.3B, J1.4B, J1.5B

### IO Board A/A Active Outputs:

Designator	Uo/V	Io/mA	Po/mW	Co/nF	Lo/uH
A-OUT1+(J3.1A)---A-IN8+(J3.8A)	12.6	92	610	100	400

Common GND connections: A-OUT\*-: J3.1B, J3.2B, J3.3B, J3.4B, J3.5B, J3.6B, J3.7B, J3.8B

## Application specific notes:

- Install cable seal between differently rated areas per country-specific regulations
- Discrete I/O active input: connection to simple apparatus (e.g. operator switches) according ATEX/IECEx regulations respectively country specific guidelines.  
For US: NEC (NFPA70), section 504.2 and 504.4
- Also refer to general notes on page 1

<b>NOTICE</b>
THIS ITEM USED IN: <input checked="" type="checkbox"/> AGENCY APPROVED PRODUCT DO NOT CHANGE DOCUMENT WITHOUT APPROPRIATE APPROVAL

<b>METTLER TOLEDO</b>	MTCT	Drawn	Zhang YongJun	2021/11/16	Scale	1:1		
	CN-213125 ChangZhou	Change			Format	mt_A4		
Refer to protection notice ISO 16016 / Schutzvermerk ISO 16016 beachten		Note	-		Replaces			-
Description IND500x 控制接线图		ERP NO.				ERP Rev		
<b>Control Drawing IND500x</b>		<b>30595335</b>				<b>A</b>		
External Design No.:		External Design Rev.: A		Status: NOT Approved		Mass:		Units: mm 9/15

# IND560x FO Board connection

CASE 1: connect with 2 channel devices in safe area

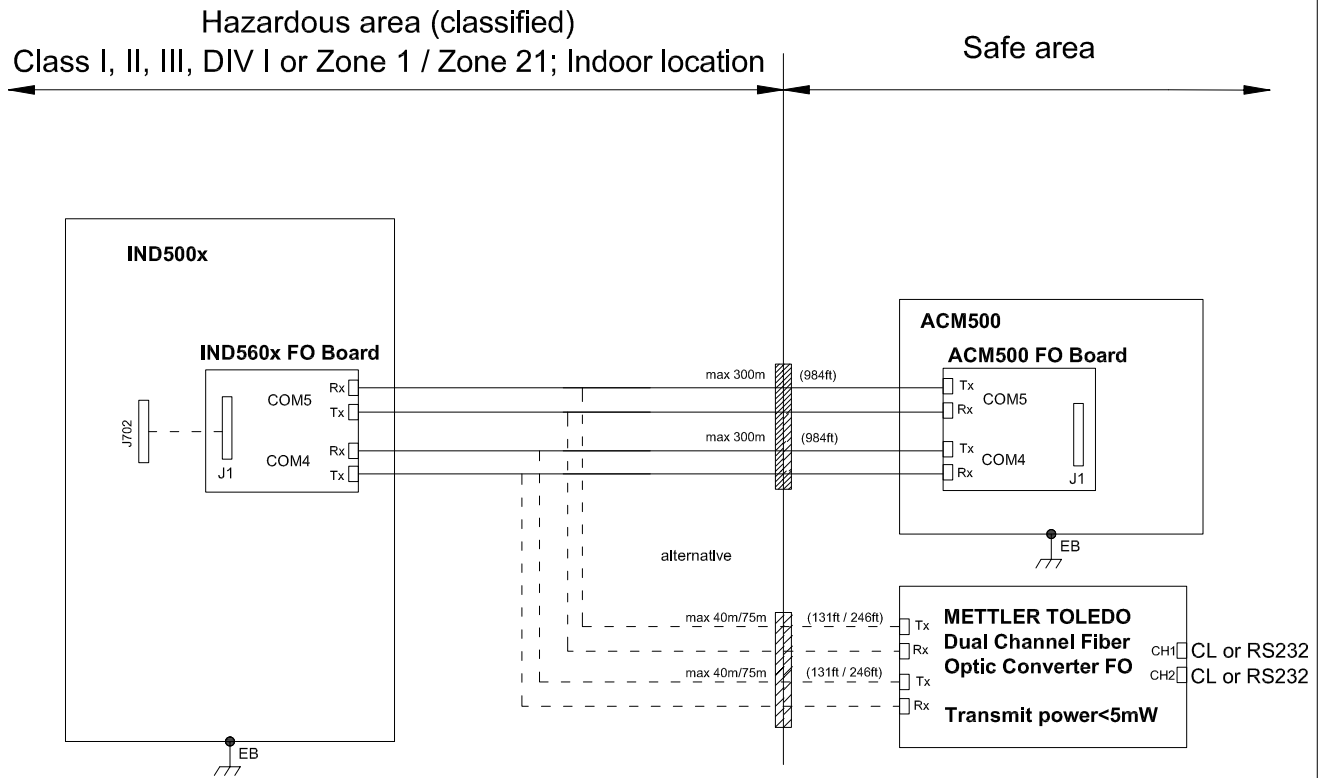

## Entity Parameters:

### IND560x FO board

The highest continuous light output power at transmission data line and the highest continuous light input power at receiving data line is:

FO-COM4 Pout < 5mW Pin < 35mW

FO-COM5 Pout < 5mW Pin < 35mW

## Application specific notes:

- Install cable seal between differently rated areas per country-specific regulations
- HCS fiber maximum length 300m (984 ft) or POF fiber maximum length 40m (131 ft) @ 115kbd or 75m (246 ft) @ 9600bd
- Also refer to general notes on page 1

## NOTICE

THIS ITEM USED IN:  
 AGENCY APPROVED PRODUCT  
 DO NOT CHANGE DOCUMENT  
 WITHOUT APPROPRIATE APPROVAL

<b>METTLER TOLEDO</b>	MTCT	Drawn	Zhang YongJun	2021/11/16	Scale	1:1		
	CN-213125 ChangZhou	Change			Format	mt_A4		
Refer to protection notice ISO 16016 / Schutzvermerk ISO 16016 beachten		Note	-		Replaces			-
Description IND500x 控制接线图		ERP NO.			ERP Rev			
<b>Control Drawing IND500x</b>		<b>30595335</b>			<b>A</b>			
External Design No.:	External Design Rev.: A	Status:	NOT Approved	Mass:	Units:	mm	10/15	



# IND560x FO Board connection

CASE 2: connect with 1 channel devices in safe area

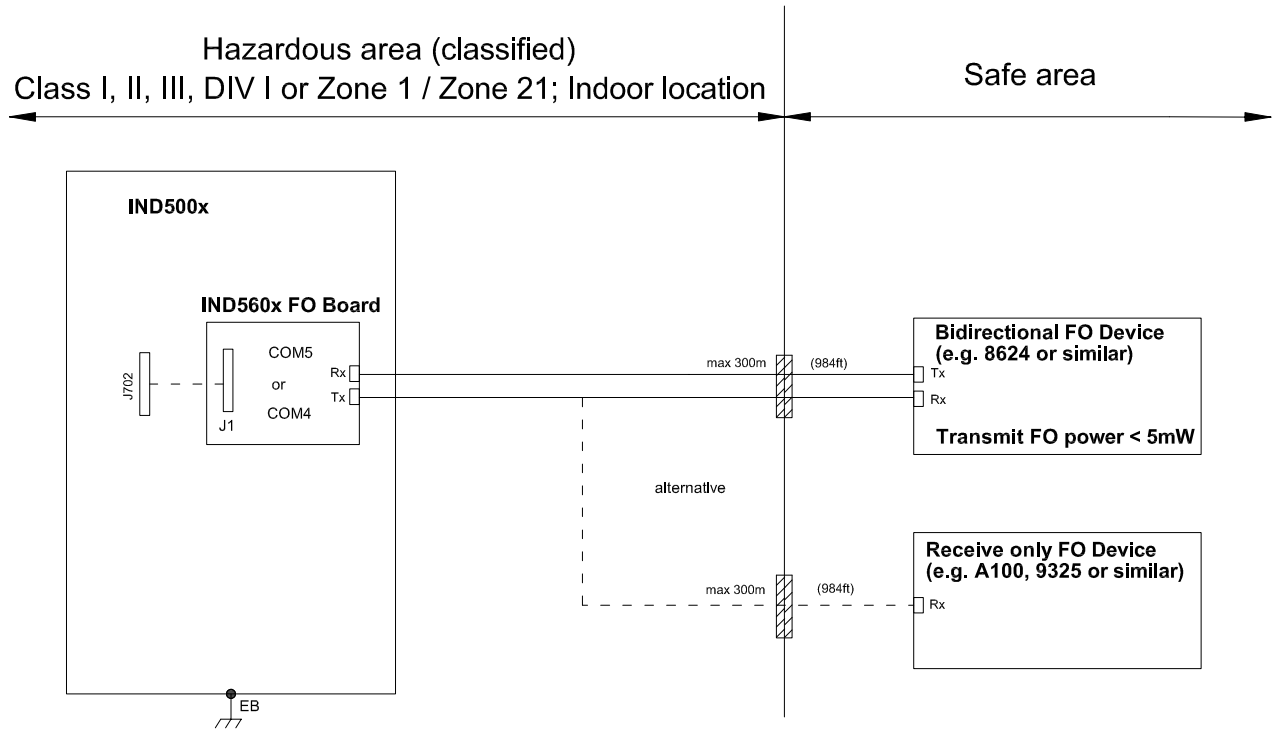

## Entity Parameters:

### IND560x FO board

The highest continuous light output power at transmission data line and the highest continuous light input power at receiving data line is:

FO-COM4 Pout < 5mW Pin < 35mW

FO-COM5 Pout < 5mW Pin < 35mW

## Application specific notes:

- Install cable seal between differently rated areas per country-specific regulations
- HCS fiber maximum length 300m (984 ft) or  
POF fiber maximum length 40m (131 ft) @ 115kbd or 75m (246 ft) @ 9600bd
- Also refer to general notes on page 1

## NOTICE

THIS ITEM USED IN:  
 AGENCY APPROVED PRODUCT  
 DO NOT CHANGE DOCUMENT  
 WITHOUT APPROPRIATE APPROVAL

<b>METTLER TOLEDO</b>	MTCT	Drawn	Zhang YongJun	2021/11/16	Scale	1:1		
	CN-213125 ChangZhou	Change			Format	mt_A4		
Refer to protection notice ISO 16016 / Schutzvermerk ISO 16016 beachten		Note	-		Replaces			-
Description IND500x 控制接线图		ERP NO.			ERP Rev			
<b>Control Drawing IND500x</b>		<b>30595335</b>			<b>A</b>			
External Design No.:	External Design Rev.: A	Status:	NOTApproved	Mass:	Units:	mm	11/15	

# IND560x FO Board connection

CASE 3: connect with devices in hazardous area

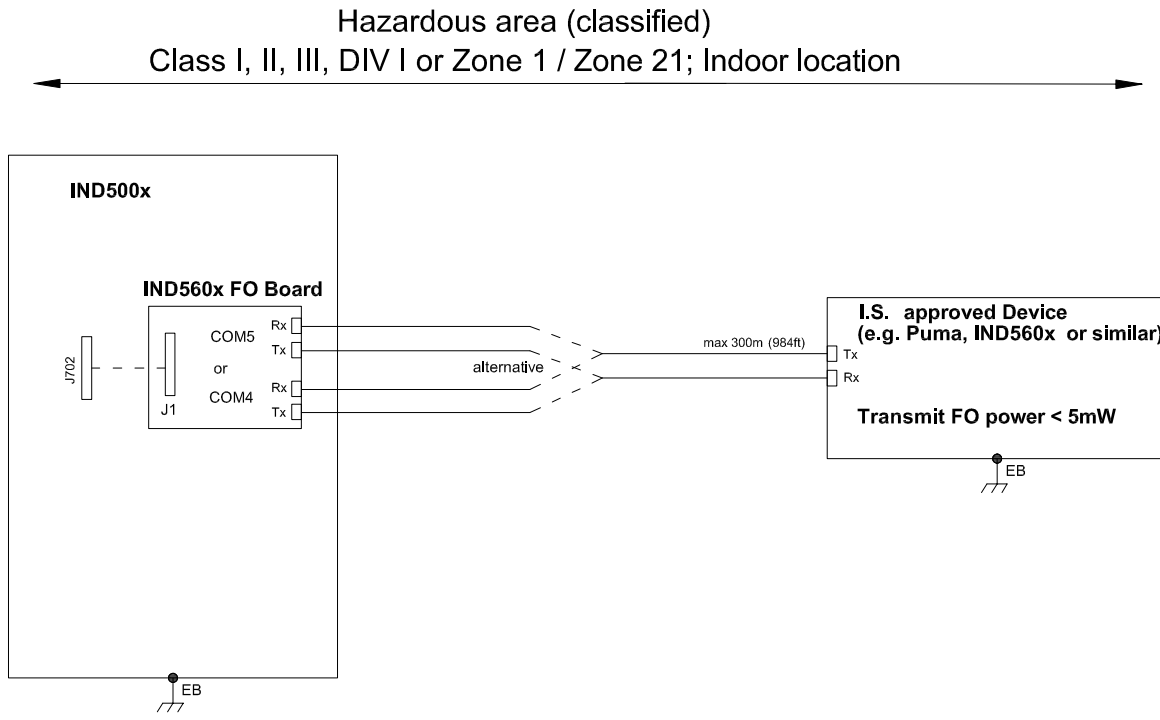

## Entity Parameters:

### IND560x FO board

The highest continuous light output power at transmission data line and the highest continuous light input power at receiving data line is:

FO-COM4 Pout < 5mW Pin < 35mW

FO-COM5 Pout < 5mW Pin < 35mW

## Application specific notes:

- HCS fiber maximum length 300m (984 ft) or POF fiber maximum length 40m (131 ft) @ 115kbd or 75m (246 ft) @ 9600bd
- Also refer to general notes on page 1

## NOTICE

THIS ITEM USED IN:  
 AGENCY APPROVED PRODUCT  
 DO NOT CHANGE DOCUMENT  
 WITHOUT APPROPRIATE APPROVAL

<b>METTLER TOLEDO</b>	MTCT	Drawn	Zhang YongJun	2021/11/16	Scale	1:1		
	CN-213125 ChangZhou	Change			Format	mt_A4		
Refer to protection notice ISO 16016 / Schutzvermerk ISO 16016 beachten		Note	-		Replaces			-
Description IND500x 控制接线图		ERP NO.			ERP Rev			
<b>Control Drawing IND500x</b>		<b>30595335</b>			<b>A</b>			
External Design No.:	External Design Rev.: A	Status:	NOT Approved	Mass:	Units:	mm	12/15	

# Active CL Board connection

CASE 1: connect with ACM500 in safe area

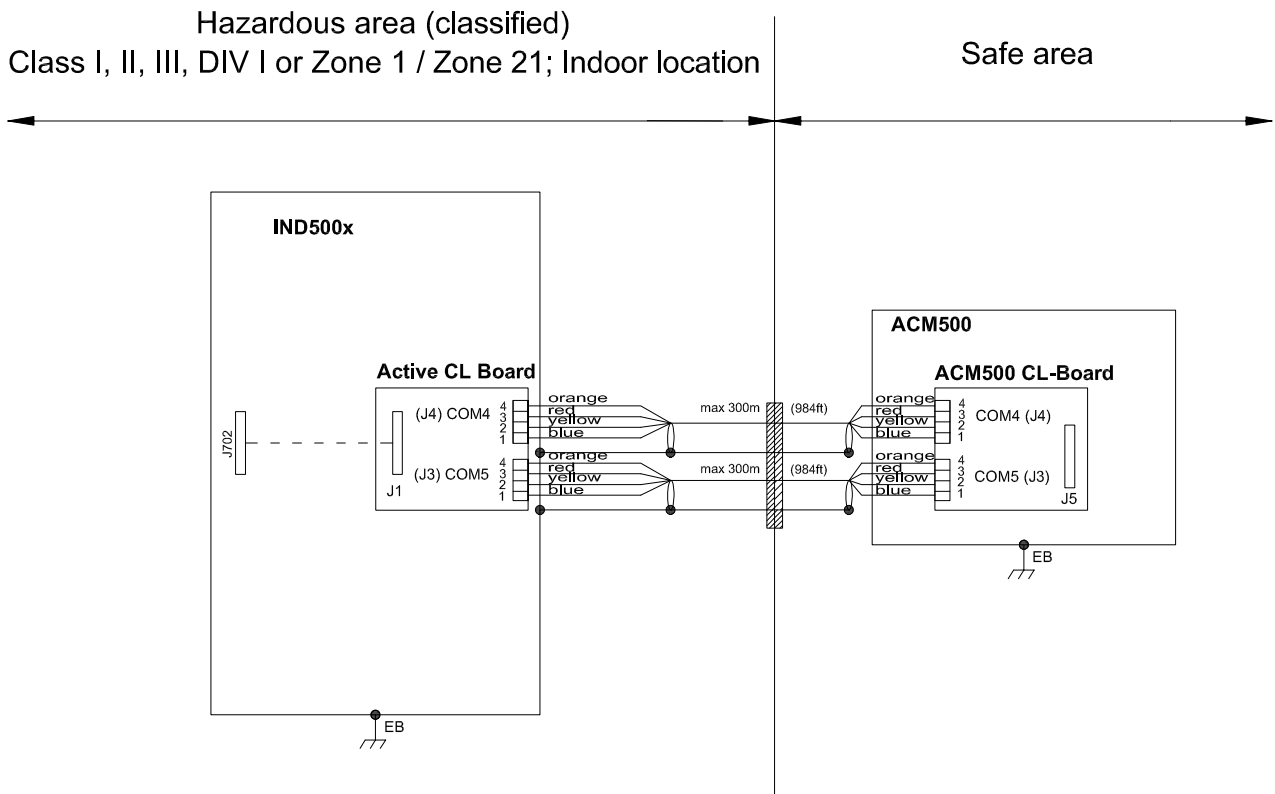

## Entity Parameters:

### Active current loop board

Designator	Uo/V	Io/mA	Po/mW	Co/nF	Lo/uH
COM 4 ( J4 )	5.88	133	211	600	400
COM 5 ( J3 )	5.88	133	211	600	400

## Application specific notes:

- Install cable seal between differently rated areas per country-specific regulations
- Don't connect cable shield at ACM500 / ACM200 end. Maximum length 300m (984 ft)
- Also refer to general notes on page 1

## NOTICE

THIS ITEM USED IN:  
 AGENCY APPROVED PRODUCT  
 DO NOT CHANGE DOCUMENT  
 WITHOUT APPROPRIATE APPROVAL

<b>METTLER TOLEDO</b>	MTCT	Drawn	Zhang YongJun	2021/11/16	Scale	1:1		
	CN-213125 ChangZhou	Change			Format	mt_A4		
Refer to protection notice ISO 16016 / Schutzvermerk ISO 16016 beachten		Note	-		Replaces			-
Description IND500x 控制接线图		ERP NO.			ERP Rev			
<b>Control Drawing IND500x</b>		<b>30595335</b>			<b>A</b>			
External Design No.:	External Design Rev.: A	Status:	NOTApproved	Mass:	Units:	mm	13/15	

# Active CL Board connection

CASE 2: connect with ACM200 in safe area

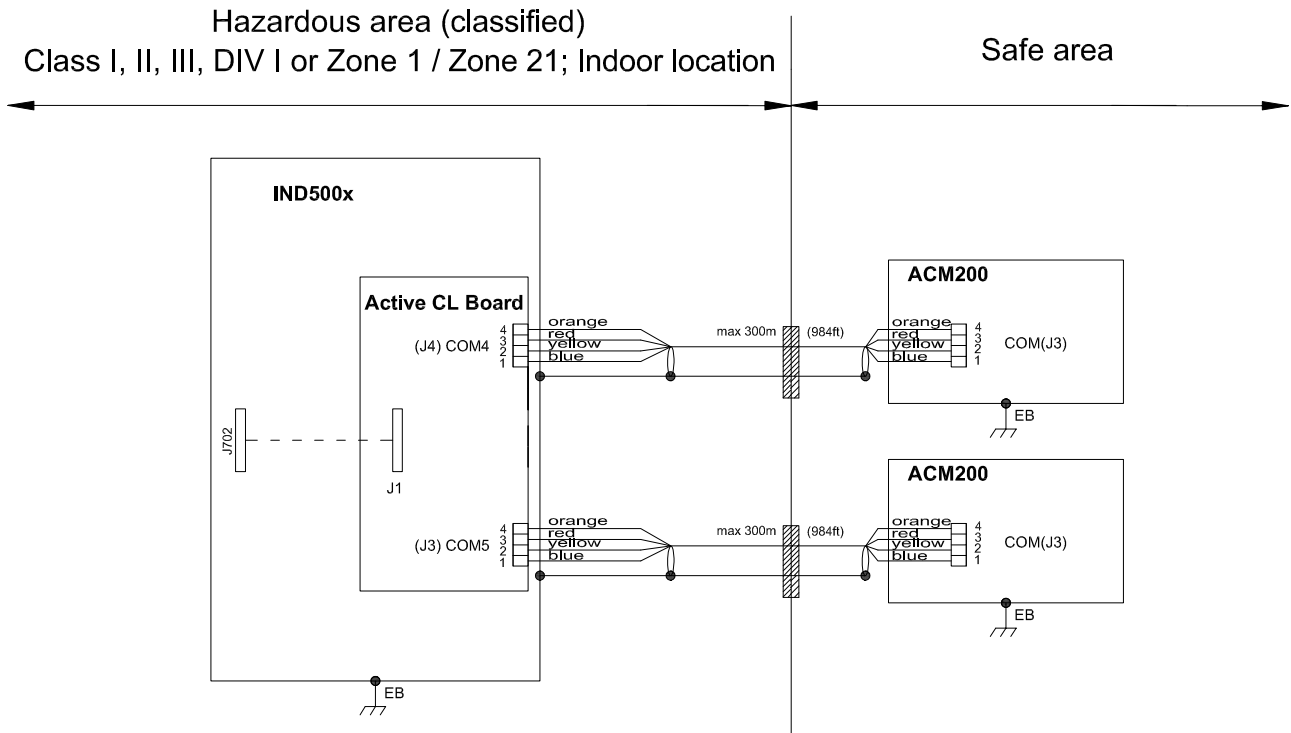

## Entity Parameters:

### Active current loop board

Designator	Uo/V	Io/mA	Po/mW	Co/nF	Lo/uH
COM 4 ( J4 )	5.88	133	211	600	400
COM 5 ( J3 )	5.88	133	211	600	400

## Application specific notes:

- Install cable seal between differently rated areas per country-specific regulations
- Don't connect cable shield at ACM500 / ACM200 end. Maximum length 300m (984 ft)
- Also refer to general notes on page 1

## NOTICE

THIS ITEM USED IN:  
 AGENCY APPROVED PRODUCT  
 DO NOT CHANGE DOCUMENT  
 WITHOUT APPROPRIATE APPROVAL

<b>METTLER TOLEDO</b>	MTCT	Drawn	Zhang YongJun	2021/11/16	Scale	1:1		
	CN-213125 ChangZhou	Change			Format	mt_A4		
Refer to protection notice ISO 16016 / Schutzvermerk ISO 16016 beachten		Note	-		Replaces			-
Description IND500x 控制接线图		ERP NO.			ERP Rev			
<b>Control Drawing IND500x</b>		<b>30595335</b>			<b>A</b>			
External Design No.:	External Design Rev.:	A	Status:	NOT Approved	Mass:	Units:	mm 14/15	

# Active CL Board connection

CASE 3: connect with intrinsically safe devices with passive CL board in hazardous area

Hazardous area (classified)  
Class I, II, III, DIV I or Zone 1 / Zone 21; Indoor location

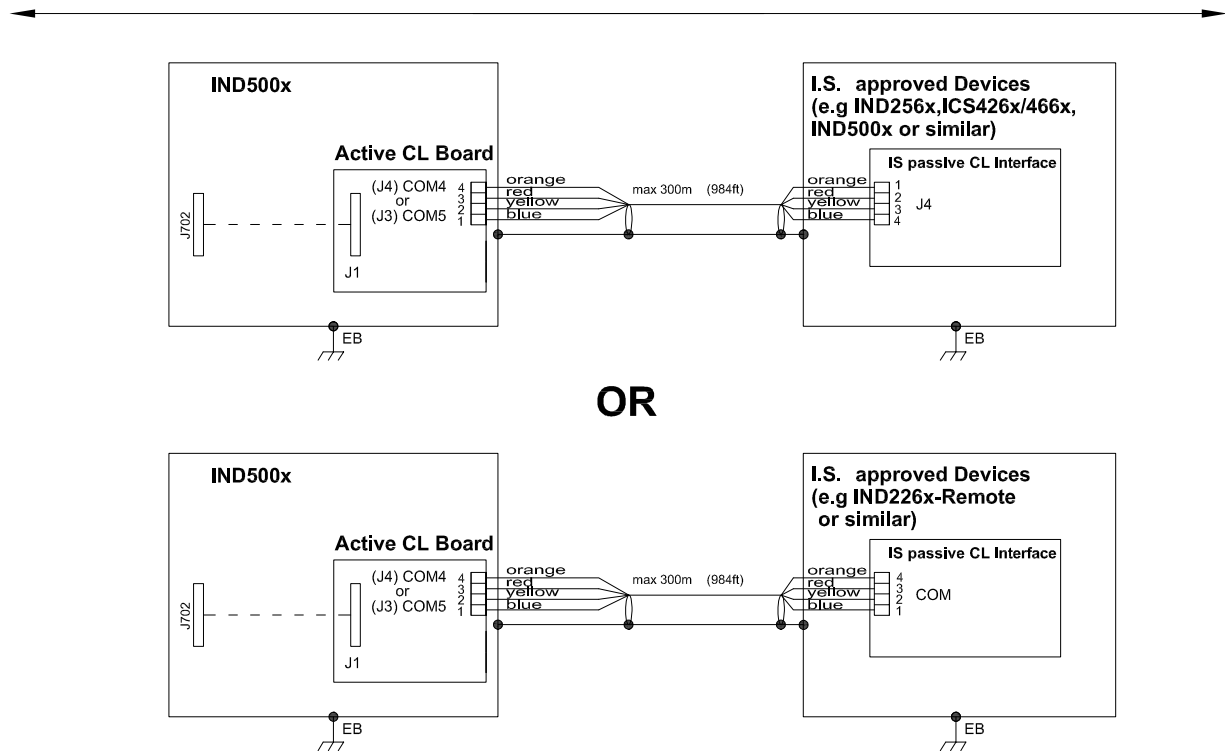

## Entity Parameters:

### Active current loop board

Designator	Uo/V	Io/mA	Po/mW	Co/nF	Lo/uH
COM 4 ( J4 )	5.88	133	211	600	400
COM 5 ( J3 )	5.88	133	211	600	400

## Application specific notes:

- Also refer to general notes on page 1

<b>NOTICE</b>
THIS ITEM USED IN: <input checked="" type="checkbox"/> AGENCY APPROVED PRODUCT DO NOT CHANGE DOCUMENT WITHOUT APPROPRIATE APPROVAL

<b>METTLER TOLEDO</b>	MTCT	Drawn	Zhang YongJun	2021/11/16	Scale	1:1		
	CN-213125 ChangZhou	Change			Format	mt_A4		
Refer to protection notice ISO 16016 / Schutzvermerk ISO 16016 beachten		Note	-		Replaces			-
Description IND500x 控制接线图		ERP NO.			ERP Rev			
<b>Control Drawing IND500x</b>		<b>30595335</b>			<b>A</b>			
External Design No.:	External Design Rev.: A	Status:	NOT Approved	Mass:	Units:	mm	15/15	

## 5.3 Default Settings

Setup Feature	Default Value			Security Access
	Analog Scale	IDNet Scale	SICSpro Scale	
<b>Scale - Type</b>				
Name	Scale 1	Scale 1	Scale 1	Administrator
Scale Type	Analog	IDNet	SICSpro	
Platform Serial Number	--	--	--	
Approval	None	None	None	
Class	II	--	--	
Verified Interval	e=d	--	--	
Power up delay:	Disabled	Disabled	Disabled	
<b>Scale - Advanced Setup Mode</b>				
Advanced Setup Mode (ASM) is found only in the SICSpro type scales. Settings such as Capacity, Increment, Zero, Tare, Filtering and Calibration are found within ASM.				
<b>Scale - Capacity &amp; Increment</b>				
Primary Units	kg	kg	kg	Administrator
#Ranges/Intervals	1	--	--	
>  1  <	50 x 0.01	--	--	
X10 Always	--	Disabled	--	
Blank Over Capacity	5 d	--	--	
<b>Scale - Calibration</b>				
Geo Code	16	--	--	Administrator
Base Serial Number	[blank]	[blank]	--	
Calibration Units	kg	--	--	
Linearity Adjust	Disabled	--	--	
<b>Scale - Zero - AZM &amp; Display</b>				
Auto Zero	Gross	Enabled	--	Administrator
Auto Zero Range	0.5 d	--	--	
Under Zero Blanking	5 d	--	--	
Power Up	Restart	Reset	--	
Timed Zero	Disabled	Disabled	Disabled	
<b>Scale - Zero - Ranges</b>				
Power Up Zero	Disabled	--	--	Administrator
Pushbutton Zero	Enabled	Enabled	--	
Ranges	+2% ~ -2%	--	--	
<b>Scale - Tare - Types</b>				
Pushbutton Tare	Enabled	Enabled	--	Administrator
Keyboard Tare	Enabled	Enabled	--	
Net Sign Correction	Disabled	Disabled	--	
Terminal Tare	--	Disabled	--	
<b>Scale - Tare - Auto Tare</b>				
Auto Tare	Disabled	Disabled	--	Administrator
<b>Scale - Tare - Auto Clear</b>				

Setup Feature	Default Value			Security Access
	Analog Scale	IDNet Scale	SICSpro Scale	
Auto Clear Tare	Disabled	Disabled	--	Administrator
Clear After Print	Disabled	Disabled	--	
Clear With Zero	Disabled	Disabled	--	
Power Up	Restart	Restart	--	
<b>Scale - Units</b>				
Second Unit	None	None	None	Administrator
Third Unit	None	None	None	
Power Up	Restart	Restart	--	
<b>Scale - Rate</b>				
Weight Units	None	None	None	Administrator
Time Units	Seconds	Seconds	Seconds	
Measurement Period	1 second	1 second	1 second	Administrator / Supervisor
Output Average	5 seconds	5 seconds	5 seconds	
<b>Scale - Filter</b>				
Low Pass Frequency	2.0 Hz	--	--	Administrator
Low Pass # of Poles	8	--	--	
Notch Filter Frequency	30 Hz	--	--	
Stability Filter	Disabled	--	--	
Vibration	--	Average Conditions	--	
Weighing Process	--	Fine Filling	--	
Update Rate	--	20	--	
<b>Scale - Stability</b>				
Motion Range	1.0 d	--	--	Administrator
No-motion Interval	0.3 seconds	--	--	
Timeout	3 seconds	3 seconds	3 seconds	
Stability	--	2	--	
<b>Scale - Log or Print</b>				
Minimum Weight	0 kg	0 kg	0 kg	Administrator
Interlock	Disabled	Disabled	Disabled	
Automatic	Disabled	Disabled	Disabled	
<b>Scale – MinWeigh - MinWeigh</b>				
Minimum Weight Determined(MWdet)	0 kg	0 kg	0 kg	Administrator / Supervisor
Safety Factor	1	1	1	
Process Tolerance	[blank]	[blank]	[blank]	
Minimum Weight Safety Factor (MWsf)	0 kg	0 kg	0 kg	
Safe Weighing Range	From MWsf to Scale Capacity	From MWsf to Scale Capacity	From MWsf to Scale Capacity	
<b>Scale – MinWeigh – MinWeigh Behavior</b>				
Behavior	Flickering Icon and Grey Weight			Administrator / Supervisor
Threshold	Minimum Weight Safety Factor (MWsf)			
<b>Scale - Reset</b>				
Reset Scale branch to factory defaults.				Administrator

Setup Feature	Default Value	Security Access
<b>Application – Memory - Alibi</b>		<ul style="list-style-type: none"> <li>• Configure: Administrator</li> <li>• Print: Administrator / Supervisor</li> <li>• View: Administrator / Supervisor / Operator</li> </ul>
Alibi Memory	Disabled	
<b>Application – Memory - Tare Table</b>		<ul style="list-style-type: none"> <li>• Configure: Administrator / Supervisor</li> <li>• Edit/Add/Delete/Print: Administrator / Supervisor</li> <li>• Clear: Administrator / Supervisor</li> <li>• View: Administrator / Supervisor / Operator</li> </ul>
Description	Disabled	
Totalization	Disabled	
<b>Application – Memory – Target Table</b>		<ul style="list-style-type: none"> <li>• Configure: Administrator / Supervisor</li> <li>• Edit/Add/Delete/Print: Administrator / Supervisor</li> <li>• Clear: Administrator / Supervisor</li> <li>• View: Administrator / Supervisor / Operator</li> </ul>
Mode	None	
<b>Application – Operation - Target</b>		
Motion Check	Disabled	Administrator / Supervisor
<b>Application – Operation - Totalization</b>		
Mode	Disabled	Administrator / Supervisor
<b>Application – Operation – ID1 – ID4</b>		
ID Mode	Disabled	Administrator / Supervisor
<b>Application - Reset</b>		
Reset Application branch to factory defaults.		Administrator
<b>Terminal - Device</b>		
Terminal ID #1	IND500X	Administrator
Terminal ID #2	[blank]	
Terminal ID #3	[blank]	
Serial Number	[blank]	
CONNECTED DEVICES	[blank]	
Terminal – Service Info		
Service Info #1	[blank]	<ul style="list-style-type: none"> <li>• Administrator / Supervisor: Read/Write</li> <li>• Operator: Read</li> </ul>
Service Info #2	[blank]	
Service Info #3	[blank]	
<b>Terminal - Display</b>		
Backlight Timeout	10 Minutes	Administrator / Supervisor
Tare Display	Active	Administrator
Auxiliary Display	Disabled	
Metrology Line	Max/Min/e	
Backlight Adjustment	100%	Administrator / Supervisor / Operator
<b>Terminal – Region - Format Time &amp; Date</b>		
Time Format	24:MM:SS	Administrator / Supervisor
Date Format	DD/MMM/YYYY	
Date Field Separator	/	
<b>Terminal – Region - Set Time &amp; Date</b>		



Setup Feature	Default Value	Security Access
Hour	No default values	Administrator / Supervisor
Minutes		
Day		
Month		
Year		
<b>Terminal – Region - Language</b>		
Display Messages	English	Administrator
Keypad Selection	English	
External Keyboard	English	
Print Comma/Decimal	Decimal point	
Gross Legend	B/G	
<b>Terminal – Transaction Counter</b>		
Transaction Counter	Disabled	Administrator
<b>Terminal – Auto Logout</b>		
Auto Logout	Enabled	<ul style="list-style-type: none"> <li>Administrator / Supervisor: Read/Write</li> <li>Operator: Read</li> </ul>
Timeout	5 Minutes	<ul style="list-style-type: none"> <li>Administrator / Supervisor: Read/Write</li> <li>Operator: Read</li> </ul>
<b>Terminal - Reset</b>		
Reset Terminal branch to factory defaults.		Administrator
<b>Communication - Access/Security - Ethernet</b>		
Shared Data Server	Read/Write	Administrator
Web Server	Disabled	
FTP	Disabled	
TLS	Enabled	
<b>Communication – Templates - Input</b>		
Preamble Length	0	Administrator / Supervisor
Data Length	0	
Postamble Length	0	
Termination Character	CR	
<b>Communication – Templates – Output</b>		
Template	Template 1	Configure/Edit: Administrator / Supervisor
Repeat Print Field	Disabled	
<b>Communication – Reports - Format</b>		
Format	Narrow (40)	Administrator / Supervisor
Header	2	
Title	Enabled	
Record Separator	None	
Footer	5	
<b>Communication – Reports – Tare Table</b>		
Tare	Enabled	Administrator / Supervisor
Description	Disabled	
n	Disabled	
Total	Disabled	
<b>Communication – Reports – Tare Table</b>		

Setup Feature	Default Value	Security Access
Description	Disabled	Administrator / Supervisor
Parameter ID	Disabled	
Tolerance Type	Disabled	
Target	Enabled	
Tolerances/Limits	Disabled	
Totalization	Disabled	
<b>Communication – Connections</b>		
COM4 Port	Disabled	Administrator / Supervisor
COM5 Port	Disabled	
<b>Communication – Serial – COM1</b>		
Baud	9600	Administrator / Supervisor
Data Bits	8	
Parity	None	
Flow Control	None	
Interface	RS-232	
<b>Communication – Serial – COM2 -6 (Shown only if option with COM2 - 6 is installed)</b>		
Baud	9600	Administrator / Supervisor
Data Bits	8	
Parity	None	
Flow Control	None	
Interface	RS-232	
<b>Communication - Reset</b>		
Reset Communication branch to factory defaults.		Administrator
<b>Maintenance – Configure/View – Change Log</b>		
Change Log	Disabled	<ul style="list-style-type: none"> <li>• Enable / Clear: Administrator</li> <li>• View / Print: Administrator / Supervisor / Operator</li> </ul>
<b>Maintenance – Configure/View – Maintenance Log</b>		
Maintenance Log	Disabled	<ul style="list-style-type: none"> <li>• Enable / Clear / Manual Maintenance Log Entry: Administrator</li> <li>• View / Print: Administrator / Supervisor / Operator</li> </ul>
<b>Maintenance – Configure/View – Error Log</b>		
Error Log	Disabled	<ul style="list-style-type: none"> <li>• Enable / Clear: Administrator</li> <li>• View / Print: Administrator / Supervisor / Operator</li> </ul>
<b>Maintenance - Reset</b>		
Reset Maintenance branch to factory defaults.		Administrator

## 5.4 Table and Log File Structure

The IND500x terminal includes an Alibi memory file, a Tare Table, a Message Table, a Target Table, a Change Log file, a Maintenance Log file, and an Error Log file. Descriptions of each of these are included in this chapter.

### 5.4.1 Memory Tables

#### 5.4.1.1 Alibi Memory

Alibi memory stores transaction information in a preset format that is not changeable. Alibi memory can be enabled or disabled in setup at Application > Memory > Alibi.

The Alibi memory operates by storing up to 600 Alibi records in a battery-backed file as they occur. After this file is full, all of these records are written to the "alibi.bin" file in flash and the 600-record file is cleared and begins to store the next 600 records. The flash file (alibi.bin) can store up to 100,000 transactions before it rolls over and begins to overwrite the oldest file.

Each record in the Alibi Memory file includes:







Date	Time	Transaction	Gross Weight	Net Weight	Tare Weight	Preset Tare	Unit
04-Aug-2020	11:06:25	0000003	6.35	6.00	0.35		kg
04-Aug-2020	11:07:25	0000004	13.98	13.00	0.98	PT	kg
04-Aug-2020	11:08:25	0000005	13.55	13.00	0.55		oz
04-Aug-2020	11:09:02	0000006	2.20	2.20	0.00		Custom

Figure 120: Alibi Transaction Record

- Date and time stamp fields
- A transaction counter value, which is a unique numeric field that identifies the transaction (the transaction counter must be enabled in terminal setup to activate the transaction counter value)
- Gross or net weight, tare weight, preset tare, and weight unit

#### 5.4.1.1.1 View Alibi Memory Records

Alibi memory records can be viewed in setup at Application > Memory > Alibi, or they can be accessed by using either the REPORTS softkey  or the Alibi softkey  from the home screens.

- 1 Press the REPORTS softkey  or the Alibi softkey .
- 2 If the REPORTS softkey  is pressed, select Alibi Memory from the selection box shown. Press the VIEW TABLE softkey  shown at the bottom of the screen. The Alibi screen displays.
- 3 If the Alibi softkey  is pressed instead of the REPORTS softkey  from the Home screen, the Alibi screen shows directly.



Alibi			
Date	Time	Transaction	Gross W
04-Aug-2020	11:06:25	0000003	6.35
04-Aug-2020	11:07:25	0000004	13.98
04-Aug-2020	11:08:25	0000005	13.55
04-Aug-2020	11:09:02	0000006	2.20

Figure 121: Alibi

- 4 To filter the Alibi records, see [View and Print Alibi Memory ▶ Page 99].

The Alibi Memory cannot be manually cleared, but automatically cleared after the function is disabled and enabled again.



#### 5.4.1.2 Tare Table



The IND500x terminal contains a tare table with 199 records for storing tare weights that can be recalled by the operator for use instead of manually entering them for each transaction. This recall function is especially useful when certain tare values are used repeatedly. When totalization is enabled for the tare table, each time a transaction is completed using an activated tare ID, the selected weight value (gross or net weight) is added to the total and the counter increments by one.

For gross weight accumulation, the tare table can be used with tare values of 0 in order to accumulate weight by tare ID.

The counter for the tare totals is seven-digit long and has a maximum value of 1,500,000. When this value is exceeded, an overflow error displays and that value is not accumulated. The counter must be reset in order to continue totalizing. The total register is 11 digits in length including all positions to the right of the decimal point. The decimal position is determined by the display resolution for the unit entered as the tare unit. The

maximum value for a scale with a display resolution of 0.01 kg would be 999999999.99 kg. When this value is exceeded, an overflow error displays and that value is not accumulated. The total must be reset in order to continue totalizing.

These tare weights can be recalled by either selecting from a list of all the values using the TARE TABLE softkey  followed by the FILTER OFF softkey  or can be "quick accessed" directly by pressing the Tare ID value followed by the TARE TABLE softkey .

A printed report of the records in the Tare Table is available through the REPORTS softkey . Tare table reports can also be generated by pressing the TRANSFER softkey  from within Setup>Application>Memory>Tare Table.

Each record in the Tare Table includes:

ID	Value	Unit	Low Limit	High Limit	Description	n	Total
01	1	kg	0	0	Desc1	0	0.00
02	2	kg	0	0	Desc2	0	0.00
03	0	kg	2	5	Desc3	0	0.00
04	0	kg	3	5	Desc4	0	0.00

Figure 122: Tare Table View

### 5.4.1.3 Message Table

The configuration of the Message Table is under Setup>Application>Memory.



User can refer to the [Message Table ▶ Page 101] section in the chapter Configuration>Application>Memory for the information listed below:

- Clear Message Table
- View Message Table records
- Edit Message Table records
- Add a new Message Table record
- Delete Message Table records
- Print Message Table records

### 5.4.1.4 Target Table

The IND500x contains a 199-record Target Table that stores frequently used target-comparison values. The fields in the record depend upon the application selected – Manual Filling, Over/Under, Basic Auto Filling, Advanced Auto Filling or Drum Filling. There are either two or three choices for the tolerance type, depending upon the target mode selection. Totalization can be enabled or disabled.

When totalization is enabled for the target table, each time a transaction is completed using an activated target ID, the selected weight value (gross or net weight) is added to the total and the counter increments by one.

A Target Table record can be recalled by picking from a list of all the values using the TARGET TABLE softkey  followed by the FILTER OFF softkey . It can also be "quick accessed" directly by entering the Target ID value.

A printed report of the records in the Target Table is available through the TRANSFER softkey .

Each record in the Target Table includes:

ID	Description	Source	Tolerance Type	Target	Units	+Tolerance	-Tolerance	Totalization Type	n	Total
001	PX7r Green Pail	Net Weight	Target Deviation	10	kg	1	1	Net Weight	0	0.000
006	MRRG Blue Pail	Gross Weight	Percent Of Target	0	kg	9	11	Gross Weight	0	0.000
007	WOPW Red Pail	Gross Weight	Percent Of Target	10	kg	20	20	Gross Weight	0	0.000
008										





Figure 123: Target Table Record\_Manual Filling

ID	Description	Source	Parameter ID	Tolerance Type	Target	Units	+Tolerance	-Tolerance	Totalization Type	n	Total
001	milk1	Net Weight	wt0111	Target Deviation	10	kg	1	1	Net Weight	0	0.000
055	milk2	Gross Weight	wt0110	Exact Limit	0	kg	9	11	Gross Weight	0	0.000
007	milk1	Parameter	ap0151	Percent Of Target	10		20	20	Parameter	0	0.000
008											

Figure 124: Target Table Record\_Over/Under



For more details about the Target Table, see [Configure the Target Table ▶ Page 46] for Manual Filling and [Configure the Target Table ▶ Page 50] for Over/Under.

#### 5.4.1.4.1 Select A Target Record from list

- The TARGET TABLE softkey  is added to the Home Page.
- 1 Press the TARGET TABLE softkey .
  - ➔ The Target Search page shows.
- 2 Press the FILTER OFF softkey .
- 3 Use the Search Field selection boxes and associated data fields to enter specific search information to limit the search, or use the default “find all” character, the asterisk (\*) to view all records.
- 4 Press the OK softkey . The Target Table screen displays with the search results sorted by ID. The file has the lowest record ID at the top of the file and focus is on that record.
- 5 Use the RIGHT and LEFT navigation keys to view all fields of each record.
- 6 Use the UP and DOWN navigation keys to move the focus to a specific Target record.
- 7 Press the OK softkey  to load the selected record for the target.
  - ➔ The stored target value is recalled from the Target Table and is used as the preset target value. A value stored in the target table is automatically converted when recalled if it does not match the display unit.
- ➔ A Target record is selected from list.

#### 5.4.1.4.2 Quick Access to A Target Record

If the ID number for a specific target record in the Target Table is known, the record can be quickly recalled for use without going through the view and selection process.

- The TARGET TABLE softkey  is added to the Home Page.
- 1 Use the numeric keypad to enter the one - or two - digit ID for the target that is to be used.
- 2 Press the TARGET TABLE softkey  to quickly recall the ID record entered.
  - ➔ The stored target value is recalled from the Target Table and is used as the preset tare value. A value stored in the target table is automatically converted when recalled if it doesn't match the display unit.
  - ➔ If an invalid ID number is entered, an “ID Not Found” message displays.
- ➔ A Target record is selected by quick access.

#### 5.4.1.4.3 Clear Totals

All the records in the Target Table can be cleared by pressing the CLEAR softkey  in the first setup page for the table at Application>Memory>Target Table.

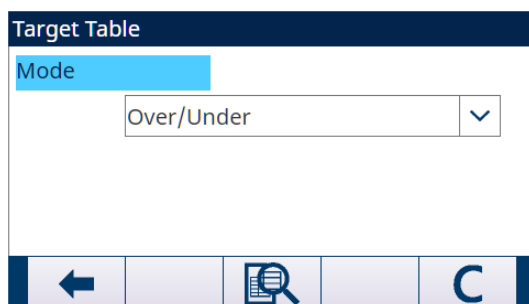









Figure 125: Target table-mode-OverUnder

The totals for all of the records in the Target Table are cleared by pressing the REPORT softkey  in Home Page, selecting Target Table from the selection box, and pressing the CLEAR TABLE TOTAL softkey .

#### Clear the Total Value of An Individual Record

- 1 Access the menu tree and move to Application>Memory>Target Table.
- 2 Press the VIEW TABLE softkey . The Target Table page shows.
- 3 Press the FILTER OFF softkey .
- 4 In the Filter Settings page, use the Search Field selection boxes and associated data fields to enter specific search information to limit the search, or use the default “find all” character, the asterisk (\*), to view all records.

- 5 Press the OK softkey . The Target Table screen displays with the search results sorted by ID.
- 6 Use the UP and DOWN navigation keys to highlight the target record for which the total is to be cleared and press the EDIT softkey . The Target Edit screen displays.
- 7 Press the DOWN navigation key to highlight the "n" and "Total" label and press ENTER.
- 8 Clear the "n" and/or "Total" values by pressing the CLEAR key on the numeric keypad when focus is in that data entry box. When the value in the data entry box is clear, press ENTER.
- 9 Press the OK softkey  to accept the changes.
- 10 Press the EXIT softkey  four times to return to the home screen.

## 5.4.2 Log Files

### 5.4.2.1 Change Log

The Change Log in the IND500x terminal file tracks all changes to shared data. The Change Log can be enabled or disabled in setup at Maintenance>Configure/View>Change Log.

The Change Log file is a linear-type file that eventually becomes full if not reset. It will hold an estimated 2,500 records. When the file becomes 75% full, a warning message displays to indicate the status. Another message displays when the file is 90% full. If the file is not reset, it will continue to store records until it is 100% full and a final 100% full message displays. Additional changes to shared data will not be recorded until the file is reset.

The Change Log file is available as a comma-delimited file (change.csv) that can be exported to the InSite program or any FTP client PC.

User could view change log on terminal or Web Server. The example of view show as below.

Date	Time	User	Object	New Value
12-Jul-2021	15:30:05	Admin	dc0101	1
12-Jul-2021	15:29:45	Admin	dc0102	2

User	For setting and table change in setup menu, the current user name shows.
	For table update, the user name who logon via FTP shows.
Object	For setting change, the parameter name (i.e. "ce0103") shows.
	For table change or update, the table name (i.e. "Tare Table") shows.

### 5.4.2.2 Maintenance Log

The "Maintenance Log" tracks service operations that an Operator or Service Technician performs with the equipment. MT Service and Validation Agencies or those who audit for them will use this log.

#### Overview

The maintenance log file is a ring-type file that overwrites the oldest record when it becomes full. The maintenance log file can hold a maximum of 2500 records. The maintenance log is recorded in File-system and won't be lost after system power-off. The used size will be checked while new log is recorded. If the used size is more than 75%, 90% or full, hint information will be thrown to System Line of Home Screen to inform user to do backup and clear maintenance log.

#### Maintenance Log Record

The maintenance log format shows as below.

Field	Data Type	Length (bytes)	Description
Date and Time	U32	7	Year/Month/Day/Hour/Minute/Second
Username	String	13	User String Name
Event Code	U8	1	Event code
Status	String	8	Log String status

#### Operation

When Event identified by Event Code happens, a record is added into Maintenance Log.

The Maintenance Event Code, Event and related possible status are illustrated in the following table.

Event Code	Event Description	Status (String)
1	Calibration test failed.	1-n=failed at step n
2	Zero calibration performed.	FAILURE, SUCCESS, Motion
3	Span calibration performed.	FAILURE, SUCCESS, Motion
4	CalFree calibration performed.	FAILURE, SUCCESS
8	Log file exported via FTP.	MAINT, CHANGE, TACT (Action), ALIBI
9	Setup file exported - .dmt files exported via FTP.	SUCCESS
10	Metrology switch / electronic seal broken.	SUCCESS
11	Calibration Expired.	"1"=days
15	Added option component	Manual text entry
16	Removed option component	Manual text entry
17	Replaced component	Manual text entry
18	Maintenance Log initialized. When Maintenance Log is Enabled, Maintenance Log is Reset in Menu, this event will be added. Note: If Master Reset or Factory Reset is detected while terminal is powered up, system try to add this event, but default maintenance Log xr0103 is disabled, this event is not added successfully.	SUCCESS
19	Calibration values manually edited.	SUCCESS
21	Set date or time.	SUCCESS
22	Table exported.	tare, target, cont, caltw1, caltest1
23	Calibration test passed.	SUCCESS
28	Successful zero command	SUCCESS
55	Step calibration performed.	SUCCESS, FAILURE
56	1-Point Test failed.	1-n = failed at step n
57	1-Point Test expired.	"1" = Days
58	1-Point Test passed.	SUCCESS
59	Walk Test failed.	1-n = failed at step n
60	Walk Test expired.	"1" = Days
61	Walk Test passed.	SUCCESS
62	Custom Named Event Test failed.	1-n = failed at step n
63	Custom Named Event Test expired.	"1" = Days
64	Custom Named Event Test passed.	SUCCESS

Event ID 15, 16, 17 are added manually. Other Events are added automatically when the Events are triggered by Operation described in Event Description.

#### Table File Transfer

- The file to hold all Maintenance Log Records: ram:\maint.log
- The file for customer to view: gen:\maint.csv

#### 5.4.2.3 Error Log

The Error Log contains a list of all events or alarms. Customers or technicians can use this log to trace operations, events and alarms to aid troubleshooting.

## Configuration

Because the importance of an alarm varies from customer to customer, it is imperative that the customer has a choice of which alarms to receive. Disabling lower priority alarms can be used to reduce so-called “alarm floods” where too many unimportant alarms are reported.

Below is a sample of the setup table of a typical device for alarming. Level 5 alarms would always be reported and cannot be disabled due to security and liability issues. The customer always has the option to ignore alarms at their own risk.

NAMUR Level	Log	Description
5	Yes (fixed)	-
4	Yes/No	Customer could decide whether the level should be recorded.
3	Yes/No	
2	Yes/No	
1	NA	-

## Log File Size

The log file can hold a maximum of 500 records. The used size will be checked while new error is recorded. If the used size is more than 75%, 90% or full, hint information will be thrown to inform user to do backup and clear error log.

## 5.5 Communications

This section is intended as a reference concerning only the structure and setup of communication protocols supported by the IND500x terminal.



### NOTICE

#### Incorrect wiring of the communication circuits

The IND500x terminal or interface board become damaged.

- Wire the communication circuits exactly as shown in the Chapter Installation.

### Serial Interface Parameters

One standard and five optional serial ports are supported with the IND500x terminal. COM1 is the standard port, and can be found on the Main PCB of the IND500x. The optional COM2 and COM3 can be found on the Ethernet/COM2/COM3 interface that is installed in the ACM500 safe area communication module. The optional COM4 and COM5 are found on the fiber optic or intrinsically safe current loop interface boards that can be installed in the IND500x terminal. The optional COM6 can be installed on IND500x main board.

COM1 provides an RS-232 interface. This is a three-wire (TDX, RXD, and GND) interface with XON/XOFF flow-control capabilities (handshaking). This port can also be used for loading new IND500x firmware and to access the shared data server.

Optional COM2 provides only RS-232. This interface is a three-wire connection with XON/XOFF handshaking capabilities.

Optional COM3 provides RS-232, RS-422, and RS-485 interfaces. The RS-232 interface is a three-wire (TDX, RXD, and GND) with XON/XOFF flow-control capabilities (handshaking). The RS-422 is a four-wire interface designed for single point-to-point communication. The RS-485 connection is a two-wire interface but does not provide multi-drop communication with addressing. All interfaces can be output simultaneously; however, only one input can be used.

Optional COM6 provides an RS-232 interface. This is a three-wire (TDX, RXD, and GND) interface with XON/XOFF flow-control capabilities (handshaking).

Character framing is programmable in the setup mode. Framing can be:

- 1 start bit
- 7 or 8 ASCII data bits (selectable)
- 0 or 1 parity bit (none, even, or odd)
- 1 stop bit

The baud rate can be configured from 300 to 115.2K baud and a checksum character can also be configured for the standard continuous output string.



The IND500x terminal uses software handshaking to control data flow commonly referred to as XON/XOFF handshaking. When a receiving device is getting information from an IND500x terminal and cannot receive any more in its buffer, it sends an ASCII XOFF (13h) telling the IND500x terminal to temporarily stop sending data until its buffer clears.

When the device can receive more data, it sends an ASCII XON (11h) telling the IND500x terminal to begin sending data again. This process can occur as often as required by a receiving device.

The XON/XOFF method is the only type of handshaking that is supported by the IND500x terminal.

The IND500x terminal supports two different modes of data output – demand and continuous.

### 5.5.1 Demand Output Mode

The demand output mode transmits data only when the IND500x terminal receives a print request. Print requests are sent to the IND500x terminal when:

- The operator presses the PRINT button.
- A discrete input selected as print is triggered.
- An ASCII "P" is sent through a command input port.
- Auto print is enabled and all conditions for auto print are met.
- A PLC command to print is received.
- The "Print" command shared data is triggered.

When triggered, data is transmitted in a string programmed in the template editing portion of setup.

Demand mode is used typically when sending data to a printer or PC on a transactional basis.

### 5.5.2 Custom Triggers

There are three programmable custom triggers in the Connections section of setup that can be used to "trigger" a specific demand output. This could be used to provide a separate "Print" key (using a discrete input) that prints a specific template to a particular serial port or Ethernet. Using the custom triggers enables printing of different information to the same port or a different port based on which custom trigger is initiated. While not normally used, these custom triggers provide great flexibility in configuring demand outputs.

A connection using a custom trigger is configured like a standard demand output except that Trigger1, Trigger 2, or Trigger 3 is selected as the trigger instead of Scale. After making the connection, a custom trigger can be assigned to one of the discrete inputs to initiate the demand output. A custom trigger can also be initiated directly by a PLC command (refer to the IND500x Terminal PLC Interface Manual); by toggling one of the cp0101, cp0102, or cp0103 shared data variables (refer to the IND500x Shared Data Reference); or by assigning the trigger to one of the trigger softkeys (refer to Softkey Mapping section in Appendix, and to the Connections section in Chapter Setup and Configuration).

### 5.5.3 Output Templates

The IND500x provides ten fully customizable templates to define a custom string of data to be transmitted. A template can be used with a demand mode connection, a custom trigger connection or with a continuous template connection. In the setup of the terminal, a template is tied to an output connection so that when that connection is triggered, the selected template will be transmitted.

Of the ten available output templates, three contain default settings, Template 1, Template 2 and Template 5. When no application software is installed in the IND500x, the remaining templates are blank. The three default templates in the terminal from the factory are as follows:

<p>Template 1</p> <p style="text-align: center;">XX.XX kg XX.XX kg T XX.XX kg N</p>	<p>Template 2</p> <p>Scale ID Current Time Current Date</p> <p style="text-align: right;">XX.XX kg XX.XX kg T XX.XX kg N</p>
<p>Template 5</p> <p style="text-align: center;">Totals Report</p> <p>Current Time                      Current Date</p> <p>Subtotal:</p> <p>n = XXX                              XXX.XX kg</p> <p>Grand Total:</p> <p>n = XXX                              XXXX.XX kg</p>	

Figure 126: Template

Each template can store up to 1,000 bytes of data. There is no warning if a template overflows this limit until the template is saved. At this time, any information over the 1,000-byte limit will be lost. The InSite program does track the size of the template as it is being built and provides an appropriate warning if the limit is exceeded.

The table that follows defines how the 1,000 bytes are calculated.

Print Field	Space Used
IND500x Data Field	8 characters
Special Character	4 characters + code (2 or 3 characters depending on the character)
String Field	String length + quantity (1 or 2)
Justify a Field	2 characters + justify letter (L, R, C) + space limit (1, 2, or 3 characters)
Zero Fill a Field	2 characters + Z + space limit (1, 2 or 3 characters)
Repeat Character	5 characters + number (1, 2 or 3 digits for number of times repeated)
Line end <CR><LF>	7 characters

### 5.5.3.1 Template Example

The following example shows a customer ticket that has three template strings centered in a 40-character wide field, with an asterisk underline.

J.W. CAREY COMMUNICATIONS  
URBANA, ILLINOIS  
DAILY WEIGHT TOTALS  
\*\*\*\*\*

The table that follows shows the information to calculate how much of the template remains for field data.

Character Description	Character Total
IND500x Field (String 1)	8 (IND500x shared data field)
Centered (Justify in 40-character field)	2 + 1 (letter C) + 2 (two digits for quantity 40)
CR (ASCII Carriage Return character)	2 + 1 (one digit for quantity 1)
LF (ASCII Line Feed character)	2 + 1 (one digit for quantity 1)
Total formatting characters required	19
Total space required (characters on each line)	25 + 19 + 19 = 63
ASCII (*) character	1 (ASCII character)
Repeat (*) 40 times	5 (repeat) + 2 (number of repeats)
CR	2 + 1 (one digit for quantity 1)
LF (ASCII Line Feed character)	2 + 1 (one digit for quantity 1)

Character Description	Character Total
Total space for line of asterisks	14
Grand total of characters (19 + 63 + 14)	96
Total characters remaining in this template (1,000 – 96)	904

#### Template Space Calculation

- Regardless of the number of characters in an IND500x terminal data field, a template uses only eight characters (the field code).
- Justification uses four to six characters that are not used if the field remains unjustified.

### 5.5.4 Continuous Output Mode

The continuous output mode of the IND500x can be used to continuously send weight data and scale status information to a remote device such as a PC or a remote display.

#### 5.5.4.1 Standard Continuous Output

Continuous mode can be assigned to COM1, COM2, COM3, COM4, COM5, COM6 or Eprint. Checksum can be enabled or disabled on any of these ports with continuous output. A data string will be output approximately 20 times per second for baud rates above 4800 baud. If a baud rate below 4800 is selected, the output rate will be slower. At 300 baud, the output rate is only approximately 2 per second. A specific output rate can be set through a Shared Data write to field cs0121 (refer to the IND500x Shared Data Reference).

The format is fixed, except for baud rate, parity, data flow (XON/XOFF), and interface type. The data consists of 17 or 18 bytes.

Non-significant weight data and tare data digits are transmitted as spaces. The continuous output mode provides compatibility with METTLER TOLEDO products that require real-time weight data.

The table that follows shows continuous format output.

	Status2				Indicated Weight3						Tare Weight4							
Character	1	2	3	4	5	6	7	8	9	10	11	12	13	14	15	16	17	18
Data	STX 1	SWA	SWB	SWC	MSD	-	-	-	-	LSD	MS D	-	-	-	-	LSD	CR 5	CH K6

#### Notes on Continuous Output Format

- ASCII Start of Text character (02 hex), always transmitted.
- Status words.

Status Word A Bit Definitions			
Bits 2, 1, and 0			
2	1	0	Decimal Point Location
0	0	0	XXXXX00
0	0	1	XXXXX0
0	1	0	XXXXXX
0	1	1	XXXXX.X
1	0	0	XXXX.XX
1	0	1	XXX.XXX
1	1	0	XX.XXXX
1	1	1	X.XXXXX
Bits 4 and 3			
4	3		Build Code
0	1		X1
1	0		X2
1	1		X5

Status Word A Bit Definitions	
<b>Bit 5</b>	Always = 1
<b>Bit 6</b>	Always = 0

Status Word B Bit Definitions	
Status Bits	Function
Bit 0	Gross = 0, Net = 1
Bit 1	Sign, Positive = 0, Negative = 1
Bit 2	Out of Range = 1 (Over capacity or Under Zero)
Bit 3	Motion = 1, Stable = 0
Bit 4	lb = 0, kg = 1 (see also Status Byte 3, bits 0-2)
Bit 5	Always = 1
Bit 6	Zero Not Captured = 1

Status Word C Bit Definitions			
			Weight Description
<b>Bits 2, 1, and 0</b>			-
<b>2</b>	<b>1</b>	<b>0</b>	-
0	0	0	lb or kg, selected by Status Byte B, bit 4
0	0	1	grams (g)
0	1	0	metric tons (t)
0	1	1	ounces (oz)
1	0	0	troy ounces (ozt)
1	0	1	penny weight (dwt)
1	1	1	tons (ton)
1	1	1	custom units
<b>Bit 3</b>			Print Request = 1
<b>Bit 4</b>			Expand Data x 10 = 1, Normal = 0
<b>Bit 5</b>			Always = 1
<b>Bit 6</b>			Always = 0

#### 5.5.4.2 Continuous Template Output

If continuous template is selected as the assignment for a connection, a custom string of data can be configured using one of the five available templates. When a continuous template output is selected, the output rate depends on the size of the template and the baud rate selected. The rate varies from approximately once per second up to approximately 20 times per second.

The table that follows shows the estimated output rates of a 160-byte template.

Continuous Template Output Rate			
Baud Rate	Outputs / Second	Baud Rate	Outputs / Second
300	1	9600	10
600	2	19200	12
1200	4	38400	14
2400	6	57600	16
4800	8	115200	18

The template can include any combination of elements (IND500x Field Codes, ASCII characters, or print strings). Note that the output rate may be adversely affected by transmitting a large template or selecting a slow baud rate.

The template is configured as explained in Chapter 4, Setup and Configuration, and this template has the same size restrictions as described above in the Output Templates section of Demand Output Mode.

### 5.5.5 CTPZ

The CTPZ input mode provides a method for a remote serial device to trigger several basic functions when a control character is sent to the IND500x. Remote ASCII control characters and the IND500x terminal responses include:

- C – Clears the scale to gross
- T – Tares the scale (causes a pushbutton tare)
- P – Initiates a print command
- Z – Zeros the scale

All other characters are ignored. ASCII control characters can be sent in upper- or lower-case.

#### **Example: Initiate A Pushbutton Tare**

- 1 Program the terminal for CTPZ input for a specific port.
  - 2 Program the serial port parameters to match the other device.
  - 3 Send the ASCII character "T".
- ➔ A pushbutton tare is initiated.

### 5.5.6 Standard Interface Command Set (SICS) Protocol

The IND500x terminal supports the METTLER TOLEDO Standard Interface Command Set (MT-SICS), which is divided into four levels (0, 1, 2, 3), depending on the functionality of the device. The IND500x terminal supports parts of levels 0 and 1:

- MT-SICS level 0 – Command set for the simplest device
- MT-SICS level 1 – Extension of the command set for standard devices

A feature of this concept is that the commands combined in MT-SICS level 0 and 1 are identical for all devices. Both the simplest weighing device and a fully expanded weighing workstation recognize the commands of MT-SICS levels 0 and 1.

#### 5.5.6.1 Data Interface Configuration

Interface settings such as baud rate, number of data bits, parity, handshake protocols and connector pin assignments are described in Configuration > Communication Setup > Interfaces.

#### **See also**

[Communication](#) ▶ Page 118

#### 5.5.6.2 Version Number of the MT-SICS

Each level of the MT-SICS has its own version number, which can be requested with the command I1 from level 0. The IND500x supports:

- MT-SICS level 0, version 2.2x (except the ZI command)
- MT-SICS level 1, version 2.2x (except the D, DW and K commands)

#### 5.5.6.3 Command Formats

Each command received by the scale via the data interface is acknowledged by a response of the device to the transmitter. Commands and responses are data strings with a fixed format.

Commands sent to the IND500x terminal comprise one or more characters of the ASCII character set.

Commands are entered only in uppercase.

- The parameters of the command must be separated from one another and from the command name by a space (ASCII 32 dec., in the examples shown in this section, a space is represented as \_).
- Each command must be terminated by CR LF (ASCII 13 dec., 10 dec.).

The characters CR and LF, which can be inputted using the ENTER or RETURN key of most entry keypads, are not listed in this description. However, they are essential to be included for communication with the IND500x terminal.

**Example**

Command to tare the IND500x terminal: "TA\_20.00\_lb" (The command terminator CR LF is not shown.)

**5.5.6.4 Response Formats**

All responses sent by the IND500x terminal to the transmitter to acknowledge the received commands have one of the following formats:

- Response with weight value
- Response without weight value
- Error message

**Format of the Response with Weight Value**

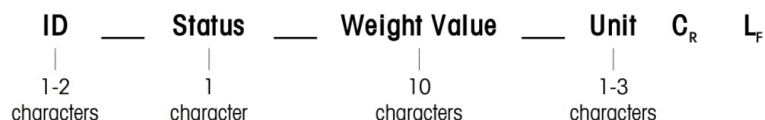

Figure 127: Format of response with weight value

- ID – Response identification
- \_\_\_ – Space (ASCII 32 dec.)
- Status – Status of the IND500x terminal. See description of the commands and responses.
- Weight Value – Weighing result, which is shown as a number with 10 digits, including sign directly in front of the first digit. The weight value appears right justified. Preceding zeroes are suppressed with the exception of the zero to the left of the decimal point.
- Unit – Weight unit displayed.
- CR – Carriage Return (ASCII 13 dec.)
- LF – Line Feed (ASCII 10 dec.)

**Example**

Response with a stable weight value of 0.256 kg: S \_ S \_ \_ \_ \_ \_ 0.256 \_ kg

**Format of the Response without Weight Value**

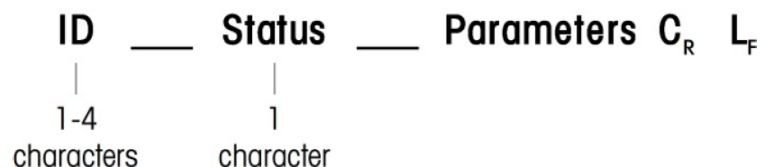

Figure 128: Format of response without weight value

- ID – Response identification
- \_\_\_ – Space (ASCII 32 dec.)
- Status – Status of the IND500x terminal. See description of the commands and responses.
- Parameters – Command-dependent response code
- CR – Carriage Return (ASCII 13 dec.)
- LF – Line Feed (ASCII 10 dec.)

**Format of Error Messages**



Figure 129: Format of error message

- ID – Error Identification
  - There are four different error messages. The identification always comprises two characters.
  - ES – Syntax error
    - The IND500x terminal has not recognized the received command.
  - ET – Transmission error
    - The scale has received a "faulty" command, such as a parity error.

- EL – Logical error  
The command is understood, the parameter is wrong.
- Internal Error  
The command is understood but cannot be executed at this time.
- CR – Carriage return (ASCII 13 dec.)
- LF – Line Feed (ASCII 10 dec.)

### 5.5.6.5 Tips for the Programmer

This section contains tips for programming the IND500x terminal SICS protocol.

#### Command and Response

The dependability of application software can be improved by having the program evaluate the response of the IND500x terminal to a command. The response is the acknowledgment that the IND500x terminal has received the command.

#### Reset

When establishing communication between the IND500x terminal and system, a reset command can be sent to the IND500x terminal to enable a start from a determined state. When the IND500x terminal or system is switched on or off, faulty characters can be received or sent.

#### Quotation Marks (“ ”)

Quotation marks included in the command responses are used to designate fields and will always be sent.

### 5.5.6.6 Commands & Responses MT-SICS Level 0

The IND500x terminal receives a command from the system computer and acknowledges the command with an appropriate response. This section contains a detailed description of the command set in alphabetical order with the associated responses. Commands and responses are closed with CR and LF. These termination characters are not shown in the following description, but they must always be entered with commands or sent with responses.

The commands of MT-SICS level 0 are available with even the simplest devices, which support the METTLER TOLEDO Standard Interface Command Set. The commands are listed as follows:

- I0 Inquiry of all implemented MT-SICS commands
- I1 Inquiry of MT-SICS level and MT-SICS versions
- I2 Inquiry of balance data
- I3 Inquiry of balance SW version and type definition number
- I4 Inquiry of serial number
- I6 Inquiry of scale build parameters
- S Send stable weight value
- SI Send weight value immediately
- SIR Send weight value immediately and repeat
- Z Zero
- @ Reset (clear out serial buffer)

#### I0 – INQUIRY OF ALL IMPLEMENTED MT-SICS COMMANDS

Command: I0 – Inquiry of all implemented MT-SICS commands

		Response	
I0 B 0 "I0"	Level 0 "I0" command implemented	I0 B 0 "I1"	Level 0 "I1" command implemented
I0 B 0 "I2"	Level 0 "I2" command implemented	I0 B 0 "I3"	Level 0 "I3" command implemented
I0 B 0 "I4"	Level 0 "I4" command implemented	I0 B 0 "S"	Level 0 "S" command implemented
I0 B 0 "SI"	Level 0 "SI" command implemented	I0 B 0 "SIR"	Level 0 "SIR" command implemented
I0 B 0 "Z"	Level 0 "Z" command implemented	I0 B 0 "@"	Level 0 "@" command implemented

IO B 1 "SR"	Level 1 "SR" command implemented	IO B 1 "T"	Level 1 "T" command implemented
IO B 1 "TA"	Level 1 "TA" command implemented	IO B 1 "TAC"	Level 1 "TAC" command implemented
IO B 1 "TI"	Level 1 "TI" command implemented		

Error Response IO I - Cannot execute command at this time.

### **I1 – INQUIRY OF MT-SICS LEVEL AND MT-SICS VERSIONS**

Command: I1 – Inquiry of MT-SICS level and MT-SICS versions

<b>Response: I 1 _ A _ "" _ "2.2x" _ "2.2x" _ " " _ " "</b>	
""	No Levels fully implemented
2.2x	Level 0, version V
2.2x	Level 1, version V2.2x
""	No MT-SICS 2 commands
""	No MT-SICS 3 commands
Error Response I1 _ I – Command understood, not executable at present.	

#### **Comments**

- In the case of the MT-SICS level, only fully implemented levels are listed. In this case, neither level 0 nor level 1 were fully implemented so the level is not specified.
- In the case of the MT-SICS version, all levels are specified even those only partially implemented.

### **I2 – INQUIRY OF DATA**

Command: I2 – Inquiry of data.

Response: I 2 \_ A \_ "IND500x \_ Standard \_50.00 kg"

Response: I 2 \_ A \_ "IND500x \_ 500xFill \_50.00 kg"

- IND500x - Model number of terminal
- Standard - Basic model with no special application software
- 500xFill - Sent when an IND500x-Fill is queried
- 50.00 kg - Capacity and primary unit of the base connected to the IND500x
- Error Response I2 \_ I – Command understood, not executable at present.

#### **Comments**

The number of characters of "text" depends on the application software and scale capacity.

### **I3 – INQUIRY OF SW VERSION AND TYPE DEFINITION NUMBER**

Command I3: Inquiry of SW version number(s) and type definition number.

Response: I3 \_ A \_ "1.00"

- 1.00 – Firmware version of the IND560x
- Error Response I3 \_ I – Command understood, not executable at present.

#### **Comment**

The number of characters of "text" depends on the revision and device type.

### **I4 – INQUIRY OF SERIAL NUMBER**

Command: I4 – Inquiry of serial number.

Response: I4 \_ A \_ "text"

- Serial number as "text" (content of shared data xs0105 in IND500x terminal)
- Error Response I4 \_ I – Command understood, not executable at present.

#### **Example**

Command: I 4 – Inquiry of serial number

Response: I 4 \_ A \_ "123456-6GG"

#### **Comments**

The serial number response is the content of the terminal serial number as entered in the setup.



## I6 – INQUIRY OF SCALE BUILD PARAMETERS

Command	I6	Inquiry of scale build parameters
Response	I6 _ IB x	x = Scale Application: I - Industrial L - Retail P – Precision
	I6 _ MAX _ maxvalue _ unit	<ul style="list-style-type: none"> <li>unit = Primary Unit</li> <li>maxvalue = Maximum capacity in Primary Unit</li> </ul>
	I6 _ MIN _ minvalue _ unit	minvalue = Minimum capacity in Primary Unit
	I6 _ TH _ ptvalue _ unit	ptvalue = Max. pre-set tare in Primary Unit
	I6 _ Ri _ resolu _ unit _ maxval _ unit	<ul style="list-style-type: none"> <li>Ri = Range Information: 0 – Single Range 1,2,3 – Partial Range / Interval info</li> <li>resolu = resolution of range/Interval Ri in Primary Unit</li> <li>maxval = Max value of range/Interval Ri in Primary Unit</li> </ul>
I6 _ E _ nd	nd = Approved resolution: 0d - non approved scale 1d - display value equals verification interval 10d – class II scale with extended resolution	

### Example

Command	I6	Inquiry of scale build parameters
Response	I6 _ IB I	Industrial Scale
	I6 MAX 15.000 kg	Max. Capacity 15.000 kg
	I6 MIN 0.040 kg	Min. Capacity 0.040 kg
	I6 TH 15.000 kg	Max. pre-set tare 15.000 kg
	I6 R1 0.002 kg/6.000 kg	Range 1: resolution 0.002 kg / Max. value 6.000 kg
	I6 R2 0.005 kg/15.000 kg	Range 2: resolution 0.005 kg / Max. value 15.000 kg
	I6 E 0d	non approved scale
<b>Comments</b>	Pvalue: for multi intervals, the ptvalue is the first interval capacity, but the real max pre-set tare maybe smaller than the first interval capacity. Minvalue: for multi Range, it is the minimum capacity of the first Range in primary unit.	

## S – SEND STABLE WEIGHT VALUE

Command: S – Send the current stable net weight.

Response:

- S \_ S \_ WeightValue \_ Unit – Current stable weight value.
- S \_ I – Weight value is in the current displayed units.
- S \_ + – IND560x in overload range.
- S \_ - – IND560x in underload range.

### Example

Command: S – Send a stable weight value.

Response: S \_ S \_ \_ \_ \_ 100.00 \_ kg. – The current, stable weight value is 100.00 kg.

### Comments

The terminal will wait for up to 3 seconds after receiving an “S” command for no-motion. If motion does not settle within this time, the command is aborted.

## SI – SEND WEIGHT VALUE IMMEDIATELY

Command: SI – Send the current net weight value regardless of scale stability.

Response:

- S \_ S \_ WeightValue \_ Unit – Stable weight value.
- S \_ D \_ WeightValue \_ Unit – Non-stable (dynamic) weight value.
- S \_ I – The command is understood, cannot execute the received command at this time (scale currently executing another command, such as tare).
- S \_ + – IND560x in overload range.
- S \_ - – IND560x in underload range.

### Example

Command: SI – Send current weight value.

Response: S \_ D \_ \_ \_ \_ \_ 129.07 \_ kg – The current weight value is unstable (dynamic) and is 129.07kg.

### Comments

- The response to the command SI is the last internal weight value (stable or dynamic) before receipt of the command SI.
- Weight value is in the current displayed units.

## SIR – SEND WEIGHT VALUE IMMEDIATELY AND REPEAT

Command: SIR – Send the net weight values repeatedly, regardless of scale stability.

Response:

- S \_ S \_ WeightValue \_ Unit – Stable weight value.
- S \_ D \_ WeightValue \_ Unit – Non-stable (dynamic) weight value.
- S \_ I – The command is understood, cannot execute the received command at this time (IND500x terminal is executing another command, such as tare).
- S \_ + – IND560x in overload range.
- S \_ - – IND560x in underload range.

### Example

Command: SIR – Send current weight values at intervals.

Response:

- S \_ D \_ \_ \_ \_ \_ 129.07 \_ kg
- S \_ D \_ \_ \_ \_ \_ 129.08 \_ kg
- S \_ D \_ \_ \_ \_ \_ 129.09 \_ kg
- S \_ D \_ \_ \_ \_ \_ 129.09 \_ kg
- S \_ D \_ \_ \_ \_ \_ 114.87 \_ kg
- . . . – The scale sends stable or non-stable weight values at intervals.

### Comments

- SIR is overwritten and cancelled by the commands S, SI, SR, and @.
- The number of weight values per second depends on the scale type and will vary from approximately 6 (older IDNet bases) to approximately 50 (SICSpro bases).
- Weight value is in the current displayed units.

## Z – ZERO

Command: Z – Zero the scale.

Response:

- Z \_ A – The following then holds:  
Scale is in gross mode  
Zero setting performed, (stability criterion and zero setting range complied with).
- Z \_ I – The command is understood, cannot execute the received command at this time (IND500x terminal is currently executing another command, such as tare, or timeout as stability was not reached.)
- Z \_ + – Upper limit of zero setting range exceeded.
- Z \_ - – Lower limit of zero setting range exceeded.

### Example

Command: Z – Zero.

Response: Z \_ A – Zero setting performed.

#### Comments

- If enabled in setup a tare value will be cleared during zero setting.
- The zero point determined during switching on is not influenced by this command (the measurement ranges remain unchanged).
- The duration of the timeout is approximately one second.

#### @ – RESET

Command: @ – Reset the scale to the condition found after switching on, but without a zero setting being performed.

Response: I 4 \_ A \_ "text" – Serial number of the scale, the scale is ready for operation.

#### Example

Command: @

Response: I4 \_ A \_ "123456-6GG" – The IND500x terminal is reset and sends the serial number.

#### Comments

- All commands awaiting responses are canceled.
- The "reset" command is always executed.
- A reset command received by the IND500x terminal during the calibration and test procedure cannot be processed.

### 5.5.6.7 Commands & Responses MT-SICS Level 1

The following commands of MT-SICS level 1 are available:

- SR – Send weight value on weight change (Send and Repeat)
- TA – Set tare value
- TAC – Clear tare value
- TI – Tare Immediately

#### SR – SEND WEIGHT VALUE ON WEIGHT CHANGE (SEND AND REPEAT)

Command: SR

- S R \_ PresetValue \_ Unit – Send the current stable weight value and then continuously after every weight change greater or equal to the preset value a non-stable (dynamic) value followed by the next stable value, range = 1d to maximum load.
- SR – If no preset value is entered, the weight change must be at least 12.5% of the last stable weight value, minimum = 30d.

Response:

- S \_ S \_ WeightValue \_ Unit – Current, stable weight value. Weight change.
- S \_ D \_ WeightValue \_ Unit – Non-stable weight value.
- S \_ S \_ WeightValue \_ Unit – Next stable weight value.
- S \_ I – The command is understood, the received command cannot be executed at this time (the IND500x terminal is currently executing another command, such as tare, or timeout as stability was not reached.)
- S \_ L – Command understood, parameter wrong.
- S \_ + – IND560x in overload range.
- S \_ - – IND560x in underload range.

#### Example

Command: S R \_ 0.50 \_ kg – Send the current stable weight value followed by every load change > 0.50 kg.

Response:

- S \_ S \_ \_ \_ \_ \_ 100.00 \_ kg – Scale stable.
- S \_ D \_ \_ \_ \_ \_ 115.23 \_ kg – More than 0.50 kg loaded.
- S \_ S \_ \_ \_ \_ \_ 200.00 \_ kg – Scale again stable.

#### Comments

- SR is overwritten and cancelled by the commands S, SI, SIR, @ and hardware break.
- If, following a non-stable (dynamic) weight value, stability has not been reached within the timeout interval, the response "S \_ I" is sent and then a non-stable weight value. Timeout then starts again from the beginning.

- The preset value must be entered in the first unit that is the weight unit displayed after the IND500x terminal is switched on.

### **T – TARE**

Command: T – Tare a stable weight value

Response:

- T\_S\_WeightValue\_Unit – Taring performed. Stability criterion and taring range comply with settings.

Current Tare weight value in current units is returned.

- T\_I – Taring not performed (scale is executing another command, zero setting, or stability timeout reached.)
- T\_+ – Upper limit of taring range exceeded.
- T\_- – Lower limit of taring range exceeded.

#### **Example**

Command: T

Response: T\_S \_ \_ \_ \_ 100.00\_kg – The IND500x accepts a tare value of 100.00 kg.

#### **Comments**

- The new tare weight value overwrites tare memory.
- The duration of the timeout depends on the scale type and its settings. If motion does not settle within this time, the command is aborted.
- Clearing tare value: See command TAC

### **TA – INQUIRE/ENTER TARE VALUE**

Command:

- TA – Inquiry of tare weight value
- TA \_ Tare Preset Value \_ Unit – Entry of a tare value.

Response:

- T A \_ A \_ TareWeightValue \_ Unit – Current Tare weight value.
- T A \_ I – The command is understood, the received command cannot be executed at this time (the IND500x terminal is currently executing another command, such as zero setting).
- T A \_ L – Command understood, parameter wrong.

#### **Example**

Command: T A \_ 10.00 \_ kg – Load a preset tare of 10 kg.

Response: T A \_ A \_ \_ \_ \_ 10.00\_k g – The IND500x accepts the 10.00 kg tare value.

#### **Comments**

- The existing tare will be overwritten by the preset tare weight value.
- The IND500x terminal will automatically round the inputted tare value to the current readability.
- The preset value must be entered in the current units.

### **TAC – CLEAR TARE VALUE**

Command: TAC – Clear tare value.

Response:

- TAC \_ A – Tare value cleared.
- TAC \_ I – The command is understood, the received command cannot be executed at this time (the IND500x terminal is currently executing another command, such as zero setting, or timeout as stability was not reached).

### **TI – TARE IMMEDIATELY**

Command: TI – Tare immediately, (store the current weight value, which can be stable or nonstable (dynamic), as tare weight value).

Response:

- T I \_ S \_ WeightValue \_ Unit – Taring performed, stable tare value.
- T I \_ D \_ WeightValue \_ Unit – Taring performed, non-stable (dynamic) tare value.
- T I \_ I – The command is understood, the received command cannot be executed at this time (the IND500x terminal is currently executing another command, such as zero setting.)
- T I \_ L – The command is understood, the parameter is wrong.

- T I \_ + – Upper limit of taring range exceeded.
- T I \_ - – Lower limit of taring range exceeded.

#### Example

Command: T I – Tare.

Response: T I \_ D \_ \_ \_ \_ \_ 117.57 \_ kg – The tare memory holds a non-stable (dynamic) weight value.

#### Comments

- Any previous tare value will be overwritten by the new tare weight value.
- Even during a non-stable (dynamic) condition, a tare weight value can be determined. However, the tare value determined in this manner may not be accurate.
- The stored tare weight value is sent in the current units.

### 5.5.7 Remote Discrete I/O (ARM100)

The IND500x provides the ability to expand the discrete input and output control to remote ARM100 devices. This ability is required when more than four inputs or six outputs are used (these are limits of the internal discrete I/O option) or it may be beneficial to have all of the I/O external to the IND500x based on the application. A total of three sets of I/O are supported in the IND500x. This could be configured as the internal discrete I/O option and two remotes or all three sets of I/O could be remotes.

The communication link from the IND500x terminal to the ARM100 remote discrete I/O module is an RTU-based RS-485 communication protocol. During power-up, if remote discrete I/O has been enabled, communication will be established between the IND500x terminal and the remote modules. Any communication errors will be shown on the system line of the IND500x.

Since the ARM100 uses the RS-485 communication link, either the ACM200 configured with the CL/RS-422/RS-485 option or the ACM500 with the optional COM3 option may be connected directly to the ARM100. For short runs of 50 feet or less, COM1 (intrinsically safe) may also be used to connect to ARM100 via a signal barrier and an RS-232 to RS-485 converter, both installed in the safe area. COM4 or COM5 (available in optional current loop and fiber optic interfaces) may also be used to connect to an ARM100 via an ACM200 module configured with the optional RS-485 interface or the dual channel fiber optic converter with an RS-232 to RS-485 converter.

This communication uses both the input and output portions of the port so it cannot be shared with any other connections. When “Remote Discrete I/O” is selected as the assignment for COM1, COM3, COM4 or COM5, the communication parameters are automatically preset by the terminal and cannot be changed from the front panel – they can only be viewed.

COM2 does not support “Remote Discrete I/O” assignment.

The parameters include:

- Baud Rate: 57600
- Data bits: 8
- Parity: None
- Flow Control: None
- Interface: RS-485

After the ARM100 modules are wired per the details in the ARM100 Installation Guide and programming the assignment in the connections portion of setup, the remote modules should be operational. When assigning functions to remote discrete I/O locations, the remote modules are addressed by 1.0.x for module #1, 2.0.x for module #2, and 3.0.x for module #3. Each module provides four inputs and six dry-contact relay outputs.

#### Example

Tare assigned to discrete I/O input address 1.0.1.

This indicates that when input #1 is turned on in remote module #1, a tare will be taken.

### 5.5.8 ASCII Input

With the IND500x terminal, an intrinsically safe bar code scanner or other intrinsically safe ASCII device can be connected to a port and used as an input device to enter ASCII data. This is done with the ASCII Input connection type. When this input type is selected, the assignment for the data received must also be specified at Communication > Templates > Input. Available assignments include:

- ID1
- Keypad

- Tare
- Tare ID
- Target ID
- Filling Material ID for Filling & Drum Filling
- Active Target.

As part of the programming for using the ASCII input, an input template must be configured. The template feature permits removal of a preamble (preceeding characters) and a postamble (trailing characters) that are not part of the desired data. Using these parameters in the setup of the input template, the number of characters to be ignored before and after the data are programmed. These must be the same for each data input string that the IND500x receives.

An input will be terminated after the receipt of the programmable "Termination Character" or a 1 second timeout of no new characters received. At this time, any input data that has been collected will be applied to the assignment that has been selected. This could be an actual value such as a preset tare value or a response for IDs, or it could initiate a look-up into the tare or target table by selecting Tare ID or Target ID.

The following notes apply to how the ASCII input is handled through the input template:

- The Preamble Length selects how many characters should be skipped at the beginning of an input string before the desired data.
- Data Length defines the maximum length of a string. All characters beginning after the Preamble through the Length selection will be used as the input.
- The Postamble length is the number of characters (before the Termination Character) that will be stripped off the data string. All other data from the Preamble Length to the Termination Character minus the Postamble Length will be used as the input string. When using an input that is always the same fixed length, this field would remain blank.
- The Termination Character is used to signal the end of the string input. It can be any ASCII control character. If "None" is selected, the timeout feature will terminate the entry.
- There is also a 1 second timeout feature that tracks the amount of time between characters. If this 1 second time is exceeded, the string will also be considered terminated.

### Example

Preamble of 2, Data length of 5, Postamble of 0, Termination Character of <CR>, Input assignment of Tare.

Data received is: <STX>P001.5 kg<CR>

The preamble of 2 removes the <STX> and P characters. The next 5 characters of 001.5 are the actual data. The postamble is set to 0 because the data field has already been filled so no characters have to be removed. The <CR> terminates the input.

This string would input 1.5 as a preset tare to the IND500x.

This same data could be obtained by programming a Preamble of 2, Data length of 8, Postamble of 3, Termination Character of <CR>. The Postamble length of 3 would remove the <space>kg from the data field since they are the last 3 characters received in front of the <CR>.



## 5.5.9 Reports

In order to print reports of the tare table, target table, or message strings, a connection must be made for the "Reports" function. When a reports connection is made to a serial port, whenever a report is run and then printed, it will be routed to the assigned port.

The structure of the printed report is selectable in setup so that all reports have the same general format. Printable fields for the tare table and target table individual reports are also selected in the [Reports ▶ Page 125] section of branch Communications.

A sample of each report in a 40 column wide and an 80 column wide print are shown in the following sections.

### 5.5.9.1 Alibi Table

The Alibi Table can be viewed or printed. Alibi memory is viewed in the same way as a search and view of any other table in the terminal. The table is accessible from the dedicated ALIBI softkey , the REPORTS softkey , or through the menu tree at Application>Memory>Alibi.

### 5.5.9.2 Tare Table Report

In Tare Table Report examples listed below, all fields were programmed to print. A (\*) record separator was selected for these reports.

#### 40 Column Example

If the first field on a line were disabled, it would not be printed and the field to the right would be shifted left. If a field on the right of a line were disabled, it would not print and that space would be blank. If all fields on a specific line were disabled, the complete line would be removed from the report.

Tare Memory Report

ID: 1 T: 26.4 kg

Desc: Blue Box #4

n: 54 Total: 52954.3 kg

\*\*\*\*\*

ID: 5 T: 3.7 kg

Desc: Green Bag #29

n: 7 Total: 25593.4 kg

\*\*\*\*\*

ID: 6 T: 23.3 kg

Desc: B16 Pallet

n: 0 Total: 0 kg

\*\*\*\*\*

#### 80 Column Example

If any field were disabled, that data would not be printed and that complete column would be removed from the report.

Tare Memory Report

ID T Description n Total

1 26.4 kg Blue Box #4 54 52954.3 kg

\*\*\*\*\*

5 3.7 kg Green Bag #29 7 25593.4 kg

\*\*\*\*\*

6 23.3 kg B16 Pallet 0 0 kg

\*\*\*\*\*

### 5.5.9.3 Target Table Report

In Target Table Report examples listed below, all fields were programmed to print. A (-) record separator was selected for these reports.

#### 40 Column Report Example

If the first field on a line were disabled, it would not be printed and the field to the right would be shifted left. If a field on the right of a line were disabled, it would not print and that space would be blank. If all fields on a specific line were disabled, the complete line would be removed from the report.

Target Memory Report

ID: 1 Target: 11.00 kg

Spill: 0.55 Fine: 0.4

+Tol: 0.1 -Tol: 0.1

Desc: White RT4 Gran

-----

ID: 2 Target: 12.35 kg

Spill: 0.48 Fine: 0.6

+Tol: 0.2 -Tol: 0.2

Desc: Mixture #7728

-----

ID: 3 Target: 23.85 kg  
Spill: 0.3 Fine: 0.8  
+Tol: 0.3 -Tol: 0.1  
Desc: Yellow #40 Pel

-----

### 80 Column Report Example

If any field were disabled, that data would not be printed and that complete column would be removed from the report.

Target Memory Report

ID Target Spill Fine +Tol -Tol Desc

1 11.00 kg 0.55 0.4 0.1 0.1 White RT4 Gran

-----

2 12.35 kg 0.48 0.6 0.2 0.2 Mixture #7728A

-----

3 23.85 kg 0.3 0.8 0.3 0.1 Yellow #40 Pel

-----

#### 5.5.9.4 Message Table Report

The Message Table contains text that can be used in print templates. There are 99 records and each record can be up to 100 characters long. In the view of the message table, only the first 20 characters of the message string are shown. The message table report can only be printed from the Message Table branch of Application using the TRANSFER softkey . An example of the 40 column wide printed report is shown below. The 80 column report will also wrap if the line exceeds the 80 character limit.

Message Report

1 James Carey

-----

2 Communications

-----

3 101 East Main Street

-----

4 This is an example of what  
the view of a string of more  
than forty characters would  
look like in a report

-----

#### 5.5.9.5 Totals Report

The Totals report will print only the fields that have been enabled for the totalizing function. If the subtotal feature is disabled, then that field will not display or print. The example below includes both the subtotal and grand total fields. The report format is always in a 40 column width for the Totals report.

Totals report	
14:25:39	20/Jul/2007
Subtotal:	
n = 6	86.19 kg
Grand Total:	
n = 27	372.76 kg

#### 5.5.10 Shared Data Access

All setup parameters, triggers and statuses in the IND500x are stored and routed through "Shared Data". This is a system of memory mapping that permits remote clients to send commands and receive data from the terminal. In order to access the shared data variables in the IND500x, a remote client must login to the Shared



Data Server. Access is provided through COM1/COM3/COM4/COM5/Ethernet Port 1701. Regardless of the method used, the same access is provided and the login procedure is very similar. The IND500x is limited to 3 simultaneous Shared Data Server logins.

### 5.5.10.1 Shared Data Server Login

Shared data access is available from the COM1 serial port and the optional Ethernet port.

#### Log to the Shared Data Server via COM1

- 1 Enable communication with the Shared Data Server with the 3 methods below:
  - Method 1** - Delete all connections to the COM1 port of the IND500x. In setup at Communication>Serial, make sure that the port settings for COM1 are 115.2 K baud / 8 data bits / No parity / 1 stop bit.
  - Method 2** - Move switch SW2-1 to its ON position. This permits communication with the Shared Data Server without deleting any connections that have been configured in setup. Setting SW2-1 to ON will cause the message "Test Mode" to appear in the system line until SW2-1 is turned OFF. To restore access to configured COM1 connections, remember to return SW2-1 to its original, OFF, position once Shared Data Server communication is ended.
  - Method 3** - At Communication>Connections, set the assignment of COM1 as "Shared Data Server". This setting allows communication with the Shared Data Server over COM1 without setting SW 2-1 to the ON position. At Communication>Serial, ensure that port settings for COM1 are 115.2 K baud / 8 data bits / No parity / 1 stop bit.
- 2 Program the serial port of the remote device as 115.2 K baud / 8 data bits / No parity / 1 stop bit.
- 3 Connect an RS-232 cable between the remote client PC and the IND500x COM1 port. Connection to the intrinsically safe COM1 port must be made via a signal barrier located in the safe area.
- 4 Open a program to communicate with the IND500x (such as HyperTerminal).
- 5 Type: user xxxxx where xxxxx is a valid username programmed in the Terminal > User branch of the setup menu tree. The access level assigned to this username will determine which shared data variables will be available.
- 6 If a password is required for the username entered in step 5, the terminal will display: 51 Enter password. If no password is required, skip to step 8.
- 7 Type: pass xxxxx where xxxxx is the valid password for the username entered in step 5.
- 8 Response from IND500x: 12 Access OK
  - ➔ The remote client is now logged onto the Shared Data Server via COM1.

#### Log to the Shared Data Server via Ethernet

The shared data server is available via port 1701. For applications that have no access to port 1701, a second port can be enabled. To enable the second port, enter the desired port number in shared data variable xs0138. This variable cannot be accessed from the front panel of the IND500x – modify it via the shared data server (port 1701) to change the second port value.

- 1 Program appropriate IP and Gateway addresses into the IND500x in the Communication, Network branch of the menu tree.
- 2 Connect a crossover cable between the remote client PC and the IND500x.
- 3 Open a program in the client PC to communicate with the IND500x (such as HyperTerminal).
- 4 Create a TCP/IP connection to the IP address programmed in the IND500x at port 1701, or the alternative port assigned using shared data variable xs0138.
  - ➔ If the IP and Gateway addresses and the cable connection are correct, the IND500x will display: Ready for user.
- 5 Type: user xxxxx where xxxxx is a valid username programmed in the Terminal > Users branch of the setup menu tree. The access level of the username used will determine which shared data variables can be accessed.
- 6 If a password is required for the username in the previous step, the terminal will display: 51 Enter password. If no password is required, skip to step 9.
- 7 Type: pass xxxxx where xxxxx is the valid password for the username entered in step 6.
- 8 Response from IND500x: 12 Access OK
  - ➔ The remote client PC is now logged onto the Shared Data Server via Ethernet.

## 5.5.10.2 Shared Data Server Commands

After connection to the Shared Data Server in the IND500x, several commands are available for use by the client. All commands can be given in either upper- or lower-case letters. The quotation marks shown are for clarity only and should not be transmitted. The valid commands are described in the following sections.

Response Format: "Read", "write", and "callback" message responses have a formatted header. The first two characters indicate the status. "00" is the success status. "99" is a failure status. The next character is the type of message, "R", "W", or "C". The next three characters are a sequence number, which cycles from 001 to 999, and then starts over again.

### "user" Command

A client must login to the SDSV using the "user" command before accessing Shared Data. The server validates the username and sends a response message back to the user. The SDSV responds with [Access OK] if no password is required or [Enter password] if a password is required.

A client can use only the "user", "pass", "help" and "quit" commands before successfully logging on.

Format: user username

Response 1: 12 Access OK

Response 2: 51 Enter Password

### "pass" Command

The user enters a password using the "pass" command. If the password is valid, the server displays the [Access OK] message. If not valid, the server displays the [No access] message.

Format: pass password

Response: 12 Access OK

### "help" Command

The "help" command returns the list of the valid commands for the IND500x.

Format: help

Response: 02 USER PASS QUIT READ R WRITE W SYSTEM CALLBACK XCALLBACK

GROUP RGROUP XGROUP CTIMER LOAD SAVE HELP NOOP

CONTOUT XCOUNTOUT PRINTOUT XPRINTOUT

### "quit" Command

The "quit" command terminates the TCP/IP connection.

Format: quit

Response: 52 Closing connection

### "read" Command

The "read" command allows the client to read a list of one or more Shared Data fields. An individual field or an entire block can be read. If more than one field is requested, the fields should be separated by a space. If successful, the server responds with a separated list of values in ASCII format. The server separates individually requested fields with a "~"; and Shared Data separates items within a block with a "^". If an error is detected, the server responds with an error message.

The maximum length of the reply message is 1,024 characters.

Format: read SDV#1 SDV#2

Example 1: read wt0101 wt0103

Response 1: 00R003~ 17.08~lb~

Example 2: read sp0100 (reads entire block)

Response 2:

00R012~XP/

0163M^1^^78^20.500000^0^0^0^1.200000^3.500000^0.150000^0.050000^0^0.000000^0.000000^0.000000^0^0^0^0^0^0^1^0.000000^0.000000^0.000000^0.000000^0.000000^~

The 'read' command can be abbreviated to the letter "r" if desired.

### "write" Command

The "write" command allows the client to write a list of one or more Shared Data fields. A single field or an entire block can be written. The maximum length of the write message is 1,024 characters. Items within a list of writes must be separated with a "~". Shared Data separates items within a block with a "^".

Format: write SDVblock#1=value1^value2^ value3

write SDV#1=value1~SDV#2=value2~SDV#3=value3

Example 1: write ak0100=abc^def^hij^lmn (writes fields into a block)

Response 2: 00W006~OK

Example 2: write aj0101=12.56~aj0150=987.653 (writes fields within a list)

Response 2: 00W007~OK

The "write" command can be abbreviated to the letter "w" if desired.

### **"system" Command**

The "system" command returns a description of the IND500x terminal. This is the same information that is shown on the Recall System Information screen of the IND500x.

Format: system

Response: OS005~ SYSTEM INFO RECALL

Model: IND500x

S/N:

ID1: IND500x

ID2: METTLER\_TOLEDO

ID3:

Software

Boot: L1.00 181348

Standard: L1.00 181349

Fill-500x: L1.00

Hardware

Analog L/C

Opt: E-Net

### **"noop" Command**

The "noop" command performs no task; it checks communication and returns an [OK] response message.

Format: noop

Response: 00OK

### **"callback" Command**

The "callback" command allows the client to define one or more fields for which the Shared Data Server sends a message to the client when the value of the callback field changes. Only certain SDV may be included in a callback command. These SDV are noted by an "rc" or "rt" status in the column after the structure column in the Shared Data document. Mainly, these are triggers that are used in the terminal. SDV with a status of "na" are not real-time SDV and cannot be used in callbacks.

The callback message contains one or more changed field names and the new value for each field. A maximum of twelve callback fields can be specified. The "ctimer" command specifies the minimum time between repeated callback messages.

Format: callback SDV#1 SDV#2

Example: callback st0102 st0103 st0104

Response 1: 00B001~OK

Response 2: 00C005~st0102=0^st0103=1^st0104=1 (sent when all of the SDV change)

Response 3: 00C006~st0104=0 (sent when only st0104 changes)

### **"xcallback" Command**

The "xcallback" command allows the client to remove one or more callback fields from the list of current SDV.

Format: xcallback SDV#1 SDV#2 or xcallback all (removes all callbacks)

Example: xcallback st0102 (removes st0102 SDV from callback)

Response: 00X008~OK

### **“group” Command**

The “group” command allows the client to define a group of callback fields. The Shared Data Server sends a message to the client when the value of any field in the group changes. The group callback message contains the group number and the values of all fields in the group in the defined order. The “ctimer” command specifies the minimum time between repeated callback messages. The maximum number of groups is six, and the maximum number of fields in a group is twelve.

Format: group n SDV#1 SDV#2 SDV#3 (where n = the number of the group 1–6)

Example: group 5 st0103 st0104 st0107 (groups target feeding and tolerance SDV into one group)

Response 1: 00B019~OK

Response 2: 00C026~group5=0^1^0 (indicates status of all 3 SDV in group 5 whenever any one of them changes)

### **“rgroup” Command**

The “rgroup” command allows the client to define a group of fields. The client can use the group number to read the entire group at once using the READ command. The maximum number of groups is six, and the maximum number of fields in a group is twelve.

Format: rgroup n SDV#1 SDV#2 (where n = the number of the group 1–6)

Example: rgroup 3 di0101 di0102 di0103 di0104 (groups all discrete inputs into one group that can be read with a single read command)

Response: 0G008~group=3, number fields=4

Read Example: r 3

Response: 00R009~1~0~1~0~

### **“xgroup” Command**

The “xgroup” command allows the client to remove one or all groups.

Format: xgroup n (where n = the group number 1 - 6) or XGROUP all (removes all groups, including “contout” and “printout”)

Example: xgroup 5 (cancels group 5)

Response: 00X011~group=5

### **“ctimer” Command**

The “ctimer” command allows the client to set the minimum time between repeated callback messages in milliseconds. The minimum allowable setting is 50 milliseconds and the maximum is 60 seconds. The default value is 500 milliseconds.

Format: ctimer n (where n is the number of milliseconds)

Example: ctimer 1000 (set the callback timing to 1 second)

Response: 00T862~new timeout=1000

### **“csave” Command**

The “csave” command saves the current callback and group settings into Shared Data for use later with the “cloud” command.

Format: csave

Response: 00L004~OK

### **“cloud” Command**

The “cloud” command loads the callback and group settings from Shared Data into the shared data server. The terminal will begin to service the loaded callback and group commands.

Format: cloud

Response: 00L001~OK

## **5.5.10.3 Use Shared Data to Select Target Table and Tare Table Records**

When the IND500x is released, there are only two ways that a user could select a Target record or a Tare record from a memory table – through a table search or by performing a quick recall using the numeric keypad and the softkeys. Beginning with version 3.0 firmware, Target and Tare records can be recalled from their respective memory tables using both Shared Data and PLC commands.

The following section outlines the sequence of steps that must be followed to recall memory table records using Shared Data. The IND500x PLC Interface Guide (# 30753830) for information regarding the use of a PLC to recall memory table records.

To recall a Target Table record or Tare Table record from a memory table, the first step is to specify the Tare or Target record ID. Then a command is issued to recall this specified record ID from either the Tare Table or the Target Table.

When the Shared Data Server is accessed via the intrinsically safe COM1, an appropriate barrier must be used.

### Recall A Target Table Record or Tare Table Record to Active Status

- 1 Log into Shared Data server. See [Shared Data Server Login ▶ Page 221]
- 2 In the Shared Data field qc0189, write the numeric ID of the record to recall from either the Target Table or the Tare Table. Numeric ID is a maximum two-digit value (1-25).
- 3 Write either a 1 or a 6 to Shared Data field qc0189. Writing a "1" will recall the ID set in qc0190 from the Tare Table; writing a "6" will recall the ID set in qc0190 from the Target Table.

NOTE:

These shared data fields are only applicable for standard functionality Over/Under or Manual Filling.

### Table Records in Output Templates

Information regarding activated Target Table and Tare Table records, including Totalization information, is available for transmission in output (print) templates. This information can be found in the "TD" block of Shared Data. The TD shared data fields will report values only if the active Tare or Target record was retrieved directly from the Tare or Target Table. If manual changes are made to the active Tare or Target record, these shared data values will report empty fields. Records can be recalled by any available means: table search, quick recall or remotely via PLC or Shared Data.

## 5.5.11 Ethernet

The optional Ethernet port for the IND500x, which is installed in the ACM500, provides a 10 Base-T connection for connection to an Ethernet network. The Ethernet port can be used for the following functions:

- Shared data access (described previously)
- Demand output
- Continuous output
- FTP
- Sending calibration alert emails
- Web Server access

### 5.5.11.1 Ethernet Connection to A PC

The optional Ethernet port for the IND500x provides a way to interface a PC to the IND500x to download and upload files and configuration information. In order to carry out these functions, the IND500x must be connected to the ACM500 with optional Ethernet board installed. The ACM500 is then connected to a PC with an Ethernet cable.

There are two types of Ethernet cables: Patch and Crossover.



Figure 130: Connection with Crossover Cable

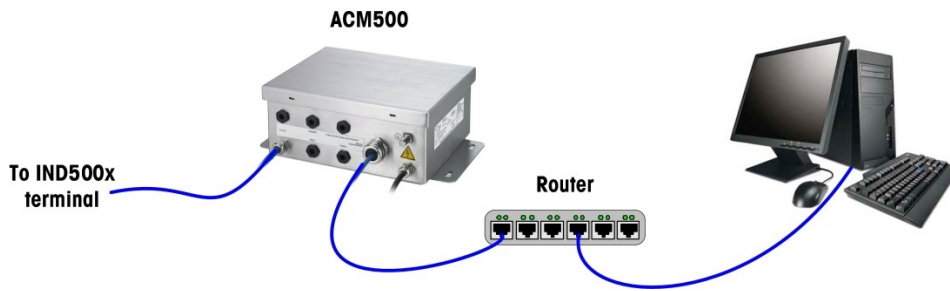

Figure 131: Connection with Patch Cables

Patch cables are used to connect a PC to a network or a hub. The easiest way to connect a PC to the ACM500 via Ethernet is to use a crossover Ethernet cable. A crossover cable connects directly from the PC Ethernet port to the ACM500 Ethernet port (no hubs or network necessary). If a crossover cable is unavailable, it is still possible to connect with two patch cables and a hub. Both types of Ethernet cables are readily available at stores that sell computer equipment.

### 5.5.11.1.1 IP Address Setup

- 1 Check the IND500x IP address and subnet mask and note the numbers to configure the PC. (Refer to the [Network ► Page 131] section in Chapter 4 Setup and Configuration for information about network configuration.)
- 2 Make sure that the PC and the IND500x have the same subnet mask.
- 3 Make sure that the PC and the IND500x have unique IP addresses. The IP address numbers must be the same where the subnet mask is 255, but different where the subnet mask is 0.

Example: IP Address Configuration (Crossover or Hub Configuration)				
IND500x IP Address	192	168	0	1
Subnet Mask	255	255	255	0
PC IP Address	192	168	0	2



Figure 132: Example: IP Address Configuration (Crossover or Hub Configuration)

- 1 Click on Start > Settings > Network Connections as shown below. The network connections screen shows.

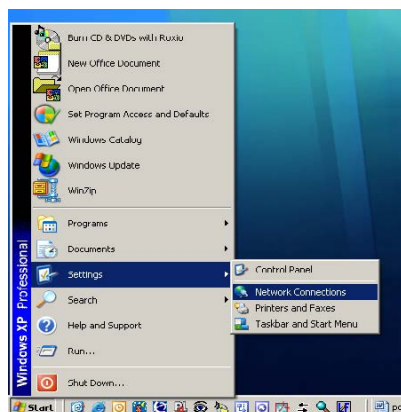

Figure 133: Network Connections Screen

- 2 Select the local area internet connection.

3 Double click on the Local Area Connection. The Local Area Connection Properties setup screen displays.

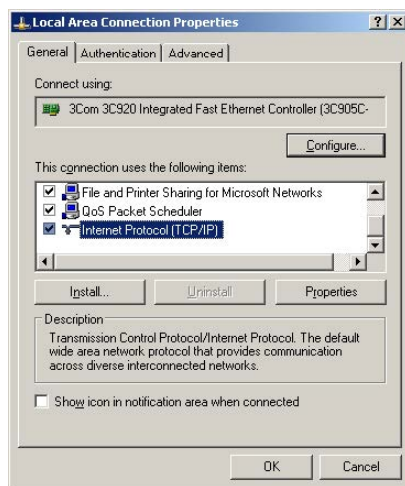

Figure 134: Local Area Connection Properties Screen

4 Scroll down to Internet Protocol (TCP/IP) and select it.

5 Click on the Properties button. The Internet Protocol (TCP/IP) Properties Screen displays.

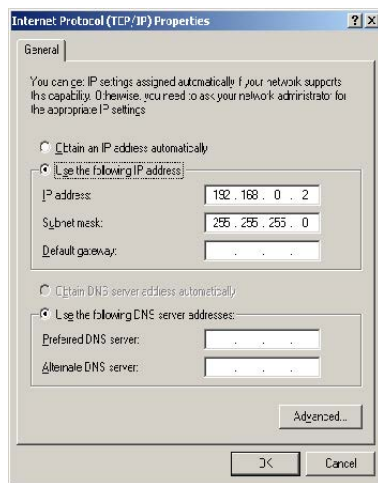

Figure 135: Internet Protocol (TCP/IP) Properties Screen

6 Typically, "Obtain an IP address automatically" is checked. However, to connect to the IND500x, set the PC IP address and subnet mask by selecting "Use the following IP address".

7 Enter the IP address and subnet mask settings for the specific PC.

8 Click on the OK button.

After disconnecting from the IND500x and before connecting back to the PC's normal network connection, remember to change the Internet Protocol (TCP/IP) Properties Screen setting back to "Obtain an IP address automatically" or to whatever setting was active when the screen was accessed.

### 5.5.11.2 Ethernet Demand Output

If a demand output connection to Ethernet is made in the connections section of setup, a remote device may "register" to receive the data through the Ethernet port. In order to do this, the remote device must login to the shared data server and send the command to register for the data. The login can be any valid username and password for the terminal.

When a user logs into the shared data server, he or she acquires the level of access for the username and password used. All levels of users can receive a demand string.

If a demand output connection to EPrint is made in the Connections section of setup, a remote device is not required to "register" with the Shared Data Server to receive the data through the Ethernet port. The data string simply contains the assigned template's information. The EPrint connection is made via the secondary TCP/IP port at the user-defined port number (set up at Communication>Network>Port).



## Register for the Demand Output

The "printout" command allows the client to define a Demand Print Stream as a callback field. The Demand Print Streams include demand print (triggered by the scale) and custom triggers (triggers 1, 2, and 3). The console print server sends a message to the client at each print output. Since print messages can span multiple message blocks (depending upon size), the start of the print message has a <dprint> tag and the end of the message has a </dprint > tag. After registering for the demand output, the client will receive the appropriate data stream. The "ctimer" command specifies the minimum time between repeated callback messages. The "xprintout" command removes the registration from the terminal and the communication will stop.

The "xgroup all" command will also terminate any demand output registrations.

### Sequence Example 1

- 1 Enter the menu tree of setup.
- 2 In the Connections sub-branch of the Communications branch of setup, create a connection for Demand Output assignment to the Ethernet port triggered by Scale using Template 2.
- 3 Ensure that the IP and Gateway addresses are programmed properly.
- 4 Login to the shared data server from the client, (see "user" command in the Shared Data Server section).
- 5 Register to receive the demand data by entering the "printout 1" command.
  - ➔ The IND500x will acknowledge the registration with a message [00Gxxx~number PRINTOUT streams=1]. Now, whenever a demand print is generated, the Template 2 data will be sent to the client.

```
OOP004 <dprint>Scale 1
01:33:10
06/Sep/2005
17.08 lb
17.08 lb T
0.00 lb N
</dprint>
```

The "xprintout" command allows the client to remove the print output callback registration thus stopping the demand output.

### Sequence Example 2

- 1 Enter the menu tree of setup.
- 2 In the Connections sub-branch of the Communications branch of setup, create a connection for Demand Output assignment to the Ethernet port triggered by Trigger 1 using Template 1.
- 3 Ensure that the IP and Gateway addresses are programmed properly.
- 4 Login to the shared data server from the client, (see "user" command in the Shared Data Server section).
- 5 Register to receive the demand data by entering the "printout 1" command.
  - ➔ The IND500x will acknowledge the registration with a message [00Gxxx~number PRINTOUT streams=1]. Now, whenever the custom trigger is initiated (by a programmed discrete input or PLC command), the Template 1 data will be sent to the client.

```
OOP004 <dprint> 17.08 lb
17.08 lb T
0.00 lb N
</dprint>
```

The "xprintout" command allows the client to remove the print output callback registration thus stopping the demand output.

## 5.5.11.3 Ethernet Continuous Output

If a continuous output type of connection to Eprint is made in the connections section of setup, a remote device is not required "register" with the Shared Data server, to receive data through the Ethernet port. The data string simply contains the assigned continuous output or template information. The Eprint connection is made via the secondary TCP/IP port at the user-defined secondary port number (configured in setup at Communication > Network > Port).

If a continuous output or continuous template output connection to Ethernet is made in the connections section of setup, a remote device may "register" to receive the data through the Ethernet port. In order to do this, the remote device must login to the shared data server and send the command to "register" for the data. The login can be any valid username and password for the terminal.



When a user logs onto the shared data server, they acquire the level of access for the username and password used. All levels of users can receive a continuous string.

### Register for the Continuous Output

The "contout" command allows the client to define the continuous output string as a callback field. The Console Print Server sends a message to the client at each continuous output. The continuous output message is either in the Standard METTLER TOLEDO Continuous Output format or in a continuous template format. The "ctimer" command specifies the minimum time between repeated callback messages. The "xcontout" command removes the registration from the terminal and the communication will stop.

The "xgroup all" command will also terminate any continuous output registrations.

### Sequence Example

- 1 Enter the menu tree of setup.
- 2 In the Connections sub-branch of the Communications branch of setup, create a connection for Continuous Output assignment to the Ethernet port triggered by Scale.
- 3 Ensure that the IP and Gateway addresses are programmed properly.
- 4 Login to the shared data server from the client, (see "user" command in the Shared Data Server section).
- 5 Register to receive the continuous data by entering the "contout" command.

- ➔ The IND500x will acknowledge the registration with a message [00Gxxx~number CONTOUT streams=1]. Now, whenever a continuous output string is generated by the IND500x, the data will be sent to the client.

```
00C148 14! 354 236
>
00C149 14! 354 236
>
00C150 14! 354 236
>
00C151 14! 354 236
```

The "xcontout" command allows the client to remove the continuous output callback registration thus stopping the continuous output.

The output rate of a Continuous type output over Ethernet is 20Hz by default. This rate cannot be modified through the terminal setup menu. However, the output rate can be modified by a Shared Data write to a field in the "cs" block of Shared Data. Please refer to the IND500x Shared Data Reference for specifics.

## 5.5.12 File Transfer

The IND500x provides the ability to transfer files using Shared Data server or FTP (file transfer protocol). METTLER TOLEDO recommends the use of the InSite PC program to assist in this transfer, but files can also be transferred through the Command prompt using a Shared Data server or an FTP client with the following commands.

- fget (Shared Data server) or get (FTP) – All files can be read using this command.
- fput (Shared Data server) or put (FTP) – Only certain files can be downloaded back to the IND500x terminal.

In order to access any files from the IND500x, the client must login to the FTP server. Valid usernames and passwords are entered according to the setup under Terminal>Users, and each username is assigned an access level. All access levels can read files but only maintenance and administrator levels can write new files to the terminal (see Chapter 4, Setup and Configuration, for further information about configuring FTP usernames, passwords, and access levels).

The following list indicates the path for the available files that can be accessed using the "fget" and "fput" commands.

gen:\bkram.dmt	These three files are the backup files for all of the setup parameters in the terminal. Retrieving and storing these files enables reloading of the terminal with the current parameters in case of a catastrophic failure. These files can be read by all but written only with Admin access right.
gen:\e2prom1.dmt	
gen:\flash.dmt	
gen:\change.csv	This is a comma-delimited file of the change log in the IND500x terminal. It can be read by all but cannot be written.
gen:\errlog.csv	This is a comma-delimited file of the error log in the IND500x terminal. It can be read by all but cannot be written.

gen:\maint.csv	This is a comma-delimited file of the maintenance log in the IND500x terminal. It can be read by all but cannot be written.
gen:\act_log1.csv	This is a comma-delimited file of the action log for advanced auto filling in the IND500x terminal. It can be read by all but cannot be written.
gen:\act_log2.csv	This is a comma-delimited file of the action log for drum filling in the IND500x terminal. It can be read by all but cannot be written.
gen:\Alibi.csv	This is a comma-delimited file of the Alibi in the IND500x terminal. It can be read by all but cannot be written.
ram:\PacStat1.txt	This is a text file that lists the PAC Statistics of Advanced Auto Filling. It can be read by all but cannot be written.
ram:\PacStat2.txt	This is a text file that lists the PAC Statistics of Drum Filling. It can be read by all but cannot be written.
flash2:\a1.csv	This is a comma-delimited file of the tare table in the IND500x terminal. It can be read by all but written only with Admin access right.
flash2:\a2_1.csv	This is a comma-delimited file of the target table of Over/Under in the IND500x terminal. It can be read by all but written only with Admin access right.
flash2:\a2_2.csv	This is a comma-delimited file of the target table of basic auto filling in the IND500x terminal. It can be read by all but written only with Admin access right.
flash2:\a2_3.csv	This is a comma-delimited file of the target table of manual filling in the IND500x terminal. It can be read by all but written only with Admin access right.
flash2:\a2_4.csv	This is a comma-delimited file of the target table of advanced auto filling in the IND500x terminal. It can be read by all but written only with Admin access right.
flash2:\a2_5.csv	This is a comma-delimited file of the target table of drum filling in the IND500x terminal. It can be read by all but written only with Admin access right.
flash2:\material1.csv	This is a comma-delimited file of the material table of advanced auto filling in the IND500x terminal. It can be read by all but written only with Admin access right.
flash2:\material2.csv	This is a comma-delimited file of the material table of drum filling in the IND500x terminal. It can be read by all but written only with Admin access right.
flash2:\matpath1.csv	This is a comma-delimited file of the material path table of advanced auto filling in the IND500x terminal. It can be read by all but written only with Admin access right.
flash2:\matpath2.csv	This is a comma-delimited file of the material path table of drum filling in the IND500x terminal. It can be read by all but written only with Admin access right.
flash2:\MFRecipes.csv	This is a comma-delimited file of the recipes in the IND500x terminal. It can be read by all but written only with Admin access right.
flash2:\MF_TransLog.csv	This is a comma-delimited file of the transaction log in the IND500x terminal. It can be read by all but written only with Admin access right.

### 5.5.12.1 FTP Example

The example describes how to upload the tare table to a PC running Microsoft Windows, modify the file, and then download it again to the terminal.

- A valid username and password from the FTP server of the IND500x terminal is necessary.
- The client knows the IP address of the IND500x and a valid network connection is established between the client and the terminal. See the section Ethernet Connection to A PC, Ethernet, Communications.

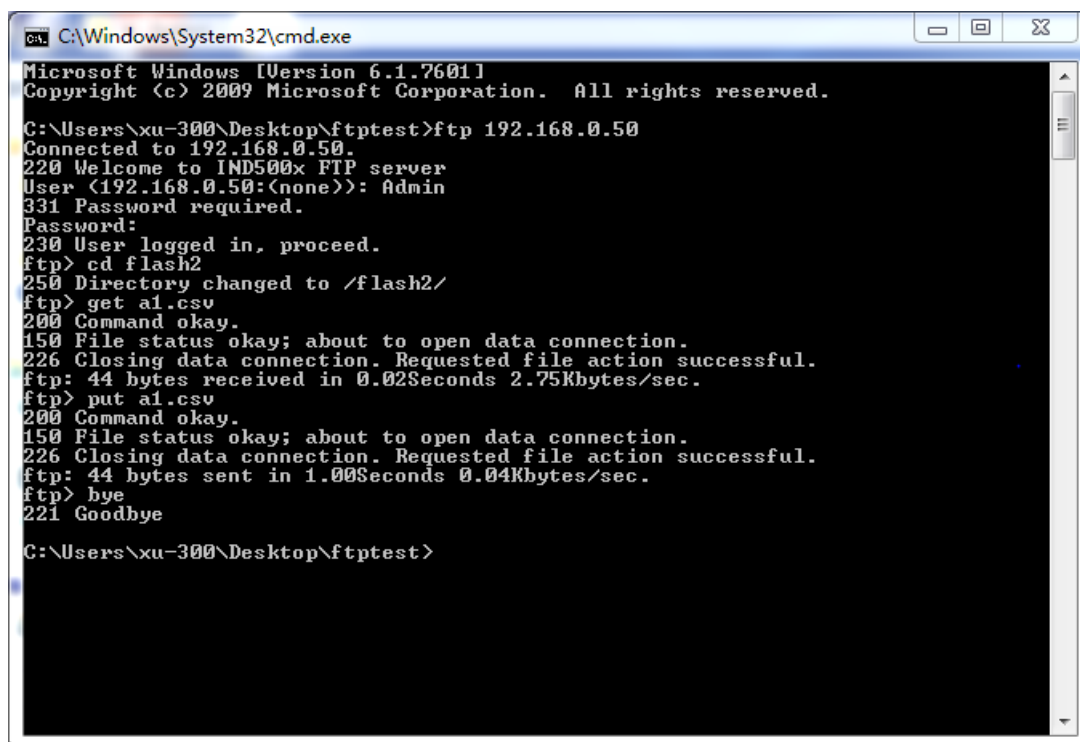

```
C:\Windows\System32\cmd.exe
Microsoft Windows [Version 6.1.7601]
Copyright (c) 2009 Microsoft Corporation. All rights reserved.

C:\Users\xu-300\Desktop\ftptest>ftp 192.168.0.50
Connected to 192.168.0.50.
220 Welcome to IND500x FTP server
User (192.168.0.50:(none)): Admin
331 Password required.
Password:
230 User logged in, proceed.
ftp> cd flash2
250 Directory changed to /flash2/
ftp> get a1.csv
200 Command okay.
150 File status okay; about to open data connection.
226 Closing data connection. Requested file action successful.
ftp: 44 bytes received in 0.02Seconds 2.75Kbytes/sec.
ftp> put a1.csv
200 Command okay.
150 File status okay; about to open data connection.
226 Closing data connection. Requested file action successful.
ftp: 44 bytes sent in 1.00Seconds 0.04Kbytes/sec.
ftp> bye
221 Goodbye

C:\Users\xu-300\Desktop\ftptest>
```

Figure 136: FTP

- 1 Open the command prompt window in the client PC and type: ftp.
- 2 Press ENTER. The command line shows: ftp>.
- 3 To open the FTP connection, type open xxx.xxx.xxx.xxx where the xxx.xxx.xxx.xxx represents the IP address of the IND500x terminal.
- 4 Press ENTER. The display indicates that service is ready and prompts for the username.
- 5 Enter the username from the IND500x FTP user list.
- 6 Press ENTER. If the username is valid, the display will prompt for a password.
- 7 Enter the password for the username used.
- 8 Press ENTER. If the login procedure is successful, the prompt line will now display: ftp>.
- 9 Enter the command: get a1.csv.
- 10 Press ENTER. This command will upload the tare table to the directory shown in the command prompt line before the FTP program is started. The client screen indicates that the transfer is successful.
- 11 Modify the file as required.
- 12 Download the modified file to the IND500x by typing: put a1.csv. The client screen indicates that the transfer is successful.
- 13 After the transfer is complete, type: quit.
- 14 Press ENTER to exit the FTP process. An acknowledgment message: Bye displays.
- 15 Type: exit.
- 16 Press ENTER to close the command line screen and return to Windows.

## 5.6 Metrological information

### Important notice for verified weighing instruments in EC-countries



Weighing Instruments, for which conformity is declared (legal verification), bear the preceding mark on the packing label and the metrology marking  $\text{M}_{xx}$  on the descriptive plate. They may be put into use immediately.



Weighing Instruments on which declaration of conformity is carried out in two steps have no metrology marking on the descriptive plate and bear the preceding identification mark on the packing label. The second step has to be carried out by the authorized METTLER TOLEDO service engineer. Please contact your METTLER TOLEDO service organization.

The first step of the declaration of conformity has been carried out at the manufacturing plant. It comprises of all tests according to EN 45501-8.3.3. If national regulations in individual countries limit the period of validity of the verification, then the users of such a weighing instrument are themselves responsible for its timely re-verification.

## 5.7 GEO Codes

The Geo code feature provided in the weighing terminal permits adjustment by a METTLER TOLEDO service technician due to changes in elevation or latitude without reapplying test weights. This assumes that a previously accurate adjustment was done with the Geo code set properly for that original location and that the Geo code for the new location can be accurately determined.

When a weighing terminal is to be reinstalled at a different geographic location, gravitational and altitude changes can be accounted for by the following steps.

Note that this procedure is not necessary if an on-site adjustment is performed.

### Determining the Geo code value

There are two methods to determine the Geo code value for your location.

#### Method A

- 1 Go to [www.welmec.org](http://www.welmec.org) and find the Gravity Information page to obtain the g value (e.g. 9.770390 m/s<sup>2</sup>) for your specific geographic location.
- 2 Check the METTLER TOLEDO Geo code Table A to select the Geo code according to your g value, e.g. Geo code 20 should be applied if your g value is 9.810304.

#### Method B

- Use the METTLER TOLEDO Geo code Table B to determine the Geo code for the new altitude and location where the scale will be used.  
The latitude and height above sea level can be found using this link [www.mapcoordinates.net/en](http://www.mapcoordinates.net/en).

### Checking the Geo code value in the instrument

#### Comparing Geo codes

- 1 Compare the determined Geo code with the current Geo code setting of the weighing terminal.
- 2 If the two Geo code values do not match, call the METTLER TOLEDO service technician.  
When the system is certified, a re-verification will be necessary.

#### Note

Using the Geo code value for calibration adjustment is not as accurate as re-applying certified test weights and re-calibrating the scale in a new location.

**Table A: Definition of METTLER TOLEDO Geo codes with g value**

Geo code	g value (m/s <sup>2</sup> )	Geo code	g value (m/s <sup>2</sup> )	Geo code	g value (m/s <sup>2</sup> )	Geo code	g value (m/s <sup>2</sup> )
0	9.770390	8	9.786316	16	9.802295	24	9.818326
1	9.772378	9	9.788311	17	9.804296	25	9.820333
2	9.774367	10	9.790306	18	9.806298	26	9.822341
3	9.776356	11	9.792302	19	9.808300	27	9.824351
4	9.778347	12	9.794299	20	9.810304	28	9.826361
5	9.780338	13	9.796297	21	9.812308	29	9.828371

Geo code	g value (m/s <sup>2</sup> )	Geo code	g value (m/s <sup>2</sup> )	Geo code	g value (m/s <sup>2</sup> )	Geo code	g value (m/s <sup>2</sup> )
6	0.782330	14	9.798295	22	9.814313	30	9.830383
7	9.784323	15	9.800295	23	9.816319	31	9.832396

**Table B: Definition of METTLER TOLEDO Geo codes with geographic latitude and height**

Geographical latitude, North or South	Height above sea level											
	[m]	0 - 325	325 - 650	650 - 975	975 - 1300	1300 - 1625	1625 - 1950	1950 - 2275	2275 - 2600	2600 - 2925	2925 - 3250	3250 - 3575
	[ft]	0 - 1060	1060 - 2130	2130 - 3200	3200 - 4260	4260 - 5330	5330 - 6400	6400 - 7460	7460 - 8530	8530 - 9600	9600 - 10660	10660 - 11730
0° 0' - 5° 46' (0.0° - 5.77°)		5	4	4	3	3	2	2	1	1	0	0
5° 46' - 9° 52' (5.77° - 12.87°)		5	5	4	4	3	3	2	2	1	1	0
9° 52' - 12° 44' (12.87° - 12.73°)		6	5	5	4	4	3	3	2	2	1	1
12° 44' - 15° 6' (12.73° - 15.1°)		6	6	5	5	4	4	3	3	2	2	1
15° 6' - 17° 10' (15.1° - 17.17°)		7	6	6	5	5	4	4	3	3	2	2
17° 10' - 19° 2' (17.17° - 19.03°)		7	7	6	6	5	5	4	4	3	3	2
19° 2' - 20° 45' (19.03° - 20.75°)		8	7	7	6	6	5	5	4	4	3	3
20° 45' - 22° 22' (20.75° - 22.37°)		8	8	7	7	6	6	5	5	4	4	3
22° 22' - 23° 54' (22.37° - 23.9°)		9	8	8	7	7	6	6	5	5	4	4
23° 54' - 25° 21' (23.9° - 25.35°)		9	9	8	8	7	7	6	6	5	5	4
25° 21' - 26° 45' (23.35° - 26.75°)		10	9	9	8	8	7	7	6	6	5	5
26° 45' - 28° 6' (26.75° - 28.1°)		10	10	9	9	8	8	7	7	6	6	5
28° 6' - 29° 25' (28.1° - 29.42°)		11	10	10	9	9	8	8	7	7	6	6
29° 25' - 30° 41' (29.42° - 30.68°)		11	11	10	10	9	9	8	8	7	7	6
30° 41' - 31° 56' (30.68° - 31.93°)		12	11	11	10	10	9	9	8	8	7	7
31° 56' - 33° 9' (31.93° - 33.15°)		12	12	11	11	10	10	9	9	8	8	7
33° 9' - 34° 21' (33.15° - 34.35°)		13	12	12	11	11	10	10	9	9	8	8
34° 21' - 35° 31' (34.35° - 35.52°)		13	13	12	12	11	11	10	10	9	9	8
35° 31' - 36° 41' (35.52° - 36.68°)		14	13	13	12	12	11	11	10	10	9	9
36° 41' - 37° 50' (36.68° - 37.83°)		14	14	13	13	12	12	11	11	10	10	9
37° 50' - 38° 58' (37.83° - 38.97°)		15	14	14	13	13	12	12	11	11	10	10
38° 58' - 40° 5' (38.97° - 40.08°)		15	15	14	14	13	13	12	12	11	11	10
40° 5' - 41° 12' (40.08° - 41.2°)		16	15	15	14	14	13	13	12	12	11	11
41° 12' - 42° 19' (41.2° - 42.32°)		16	16	15	15	14	14	13	13	12	12	11
42° 19' - 43° 26' (42.32° - 43.43°)		17	16	16	15	15	14	14	13	13	12	12
43° 26' - 44° 32' (43.43° - 44.53°)		17	17	16	16	15	15	14	14	13	13	12
44° 32' - 45° 38' (44.53° - 45.63°)		18	17	17	16	16	15	15	14	14	13	13

Geographical latitude, North or South	Height above sea level											
	[m]	0 - 325	325 - 650	650 - 975	975 - 1300	1300 - 1625	1625 - 1950	1950 - 2275	2275 - 2600	2600 - 2925	2925 - 3250	3250 - 3575
	[ft]	0 - 1060	1060 - 2130	2130 - 3200	3200 - 4260	4260 - 5330	5330 - 6400	6400 - 7460	7460 - 8530	8530 - 9600	9600 - 10660	10660 - 11730
45° 38' - 46° 45' (45.63° - 46.75°)		18	18	17	17	16	16	15	15	14	14	13
46° 45' - 47° 51' (46.75° - 47.85°)		19	18	18	17	17	16	16	15	15	14	14
47° 51' - 48° 58' (47.85° - 48.97°)		19	19	18	18	17	17	16	16	15	15	14
48° 58' - 50° 6' (48.97° - 50.1°)		20	19	19	18	18	17	17	16	16	15	15
50° 6' - 51° 13' (50.1° - 51.22°)		20	20	19	19	18	18	17	17	16	16	15
51° 13' - 52° 22' (51.22° - 52.37°)		21	20	20	19	19	18	18	17	17	16	16
52° 22' - 53° 31' (52.37° - 53.52°)		21	21	20	20	19	19	18	18	17	17	16
53° 31' - 54° 41' (53.52° - 54.68°)		22	21	21	20	20	19	19	18	18	17	17
54° 41' - 55° 52' (54.68° - 55.87°)		22	22	21	21	20	20	19	19	18	18	17
55° 52' - 57° 4' (55.87° - 57.07°)		23	22	22	21	21	20	20	19	19	18	18
57° 4' - 56° 17' (57.07° - 56.28°)		23	23	22	22	21	21	20	20	19	19	18
56° 17' - 59° 32' (56.28° - 59.53°)		24	23	23	22	22	21	21	20	20	19	19
59° 32' - 60° 49' (59.53° - 60.82°)		24	24	23	23	22	22	21	21	20	20	19
60° 49' - 62° 9' (60.82° - 62.15°)		25	24	24	23	23	22	22	21	21	20	20
62° 9' - 63° 30' (62.15° - 63.5°)		25	25	24	24	23	23	22	22	21	21	20
63° 30' - 64° 55' (63.5° - 64.92°)		26	25	25	24	24	23	23	22	22	21	21
64° 55' - 66° 24' (64.92° - 66.4°)		26	26	25	25	24	24	23	23	22	22	21
66° 24' - 67° 57' (66.4° - 67.95°)		27	26	26	25	25	24	24	23	23	22	22
67° 57' - 69° 35' (67.95° - 69.58°)		27	27	26	26	25	25	24	24	23	23	22
69° 35' - 71° 21' (69.58° - 71.35°)		28	27	27	26	26	25	25	24	24	23	23
71° 21' - 73° 16' (71.35° - 73.27°)		28	28	27	27	26	26	25	25	24	24	23
73° 16' - 75° 24' (73.27° - 75.4°)		29	28	28	27	27	26	26	25	25	24	24
75° 24' - 77° 52' (75.4° - 77.87°)		29	29	28	28	27	27	26	26	25	25	24
77° 52' - 80° 56' (77.87° - 80.93°)		30	29	29	28	28	27	27	26	26	25	25
80° 56' - 85° 45' (80.93° - 85.75°)		30	30	29	29	28	28	27	27	26	26	25
85° 45' - 90° 0' (85.75° - 90.0°)		31	30	30	29	29	28	28	27	27	26	26

## 5.8 ASCII Standard and Control Codes

DEC	HEX	Symbol	DEC	HEX	Symbol	DEC	HEX	Symbol	DEC	HEX	Symbol
0	00	NUL	64	40	@	128	80	€	192	C0	À
1	01	SOH	65	41	A	129	81		193	C1	Á
2	02	STX	66	42	B	130	82	,	194	C2	Â

DEC	HEX	Symbol	DEC	HEX	Symbol	DEC	HEX	Symbol	DEC	HEX	Symbol
3	03	ETX	67	43	C	131	83	f	195	C3	Ã
4	04	EOT	68	44	D	132	84	„	196	C4	Ä
5	05	ENQ	69	45	E	133	85	...	197	C5	Å
6	06	ACK	70	46	F	134	86	†	198	C6	Æ
7	07	BEL	71	47	G	135	87	‡	199	C7	Ç
8	08	BS	72	48	H	136	88	^	200	C8	È
9	09	HT	73	49	I	137	89	‰	201	C9	É
10	0A	LF	74	4A	J	138	8A	Š	202	CA	Ê
11	0B	VT	75	4B	K	139	8B	‹	203	CB	Ë
12	0C	FF	76	4C	L	140	8C	Œ	204	CC	Ì
13	0D	CR	77	4D	M	141	8D		205	CD	Í
14	0E	SO	78	4E	N	142	8E	Ž	206	CE	Î
15	0F	SI	79	4F	O	143	8F		207	CF	Ï
16	10	DLE	80	50	P	144	90		208	D0	Ð
17	11	DC1	81	51	Q	145	91	’	209	D1	Ñ
18	12	DC2	82	52	R	146	92	’	210	D2	Ò
19	13	DC3	83	53	S	147	93	”	211	D3	Ó
20	14	DC4	84	54	T	148	94	”	212	D4	Ô
21	15	NAK	85	55	U	149	95	•	213	D5	Õ
22	16	SYN	86	56	V	150	96	–	214	D6	Ö
23	17	ETB	87	57	W	151	97	—	215	D7	×
24	18	CAN	88	58	X	152	98	~	216	D8	Ø
25	19	EM	89	59	Y	153	99	™	217	D9	Ù
26	1A	SUB	90	5A	Z	154	9A	š	218	DA	Ú
27	1B	ESC	91	5B	[	155	9B	›	219	DB	Û
28	1C	FS	92	5C	\	156	9C	œ	220	DC	Ü
29	1D	GS	93	5D	]	157	9D		221	DD	Ý
30	1E	RS	94	5E	^	158	9E	ž	222	DE	Þ
31	1F	US	95	5F	_	159	9F	ÿ	223	DF	ß
32	20		96	60	`	160	A0		224	E0	à
33	21	!	97	61	a	161	A1	ı	225	E1	á
34	22	"	98	62	b	162	A2	ć	226	E2	â
35	23	#	99	63	c	163	A3	£	227	E3	ã
36	24	\$	100	64	d	164	A4	¤	228	E4	ä
37	25	%	101	65	e	165	A5	¥	229	E5	å
38	26	&	102	66	f	166	A6	ı	230	E6	æ
39	27	'	103	67	g	167	A7	§	231	E7	ç
40	28	(	104	68	h	168	A8	”	232	E8	è
41	29	)	105	69	i	169	A9	©	233	E9	é
42	2A	*	106	6A	j	170	AA	°	234	EA	ê
43	2B	+	107	6B	k	171	AB	«	235	EB	ë
44	2C	,	108	6C	l	172	AC	¬	236	EC	ì
45	2D	-	109	6D	m	173	AD		237	ED	í
46	2E	.	110	6E	n	174	AE	®	238	EE	î
47	2F	/	111	6F	o	175	AF	ˆ	239	EF	ï
48	30	0	112	70	p	176	BO	°	240	FO	ð
49	31	1	113	71	q	177	B1	±	241	F1	ñ

DEC	HEX	Symbol	DEC	HEX	Symbol	DEC	HEX	Symbol	DEC	HEX	Symbol
50	32	2	114	72	r	178	B2	²	242	F2	ò
51	33	3	115	73	s	179	B3	³	243	F3	ó
52	34	4	116	74	t	180	B4	´	244	F4	ô
53	35	5	117	75	u	181	B5	µ	245	F5	õ
54	36	6	118	76	v	182	B6	¶	246	F6	ö
55	37	7	119	77	w	183	B7	·	247	F7	÷
56	38	8	120	78	x	184	B8	¸	248	F8	ø
57	39	9	121	79	y	185	B9	¹	249	F9	ù
58	3A	:	122	7A	z	186	BA	º	250	FA	ú
59	3B	;	123	7B	{	187	BB	»	251	FB	û
60	3C	<	124	7C		188	BC	¼	252	FC	ü
61	3D	=	125	7D	}	189	BD	½	253	FD	ý
62	3E	>	126	7E	~	190	BE	¾	254	FE	þ
63	3F	?	127	7F		191	BF	¿	255	FF	ÿ

### 5.8.1 Control Characters

Symbol	Definition	Function
SOH	Start of Heading	A transmission control character used as the first character of a heading of an information message.
STX	Start of Text	A transmission control character that precedes a text and that is used to terminate a heading.
ETX	End of Text	A transmission control character that terminates a text.
EOT	End of Transmission	A transmission control character used to indicate the conclusion of the transmission of one or more texts.
ENQ	Enquiry	A transmission control character used as a request for a response from a remote station; the response may include station identification and/or station status. When a "Who are you" function is required on the general switched transmission network, the first use of ENQ after the connection is established will have the meaning "Who are you" (station identification). Subsequent use of ENQ may, or may not, include the function "Who are you", as determined by agreement.
ACK	Acknowledgment	A transmission control character transmitted by a receiver as an affirmative response to the sender.
BEL	Bell	A control character that is used when there is a need to call for attention; it may control alarm or attention devices.
BS	Back Space	A format effector that moves the active position one character position backwards on the same line.
HT	Horizontal Tab	A format effector that advances the active position to the next pre-determined character position on the same line.
LF	Line Feed	A format effector that advances the active position to the same character position of the next line.
VT	Vertical Tab	A format effector that advances the active position to the same character position on the next pre-determined line.
FF	Form Feed	A format effector that advances the active position to the same character position on a pre-determined line of the next form or page.
CR	Carriage Return	A format effector that moves the active position to the first character position on the same line.
SO	Shift Out / X-On	A control character that is used in conjunction with SHIFT IN and ESCAPE to extend the graphic character set of the code.
SI	Shift In / X-Off	A control character that is used in conjunction with SHIFT OUT and ESCAPE to extend the graphic character set of the code.



Symbol	Definition	Function
DLE	Data Line Escape	A transmission control character that will change the meaning of a limited number of contiguously following characters. It is used exclusively to provide supplementary data transmission control functions. Only graphic characters and transmission control characters can be used in DLE sequences.
DC1	Device Control 1 (off. XON)	A device control character that is primarily intended for turning on or starting an ancillary device. If it is not required for this purpose, it may be used to restore a device to the basic mode of operation (see also DC2 and DC3), or for any other device control function not provided by other DCs.
DC2	Device Control 2	A device control character that is primarily intended for turning on or starting an ancillary device. If it is not required for this purpose, it may be used to set a device to a special mode of operation (in which case DC1 is used to restore normal operation), or for any other device control function not provided by other DCs.
DC3	Device Control 3 (off. XOFF)	A device control character that is primarily intended for turning off or stopping an ancillary device. This function may be a secondary level stop, for example, wait, pause, stand-by or halt (in which case DC1 is used to restore normal operation). If it is not required for this purpose, it may be used for any other device control function not provided by other DCs.
DC4	Device Control 4	A device control character that is primarily intended for turning off, stopping, or interrupting an ancillary device. If it is not required for this purpose, it may be used for any other device control function not provided by other DCs.
NAK	Negative Acknowledgement	A transmission control character transmitted by a receiver as a negative response to the sender.
SYN	Synchronous Idle	A transmission control character used by a synchronous transmission system in the absence of any other character (idle condition) to provide a signal from which synchronism may be achieved or retained between data terminal equipment.
ETB	End of Transmit Block	A transmission control character used to indicate the end of a transmission block of data where data is divided into such blocks for transmission purposes.
CAN	Cancel	A character, or the first character of a sequence, indicating that the data preceding it is in error. As a result, this data is to be ignored. The specific meaning of this character must be defined for each application and/or between sender and recipient.
EM	End of Medium	A control character that may be used to identify the physical end of a medium, or the end of the used portion of a medium, or the end of the wanted portion of data recorded on a medium. The position of this character does not necessarily correspond to the physical end of the medium.
SUB	Substitute	A control character used in the place of a character that has been found to be invalid or in error. SUB is intended to be introduced by automatic means.
ESC	Escape	A control character that is used to provide additional control functions. It alters the meaning of a limited number of contiguously following bit combinations.
FS	File Separator	A control character used to separate and qualify data logically; its specific meaning has to be specified for each application. If this character is used in hierarchical order, it delimits a data item called a file.

<b>Symbol</b>	<b>Definition</b>	<b>Function</b>
GS	Group Separator	A control character used to separate and qualify data logically; its specific meaning has to be specified for each application. If this character is used in hierarchical order, it delimits a data item called a group.
RS	Record Separator	A control character used to separate and qualify data logically; its specific meaning has to be specified for each application. If this character is used in hierarchical order, it delimits a data item called a record.
US	Unit Separator	A control character used to separate and qualify data logically; its specific meaning has to be specified for each application. If this character is used in hierarchical order, it delimits a data item called a unit.



## To protect your product's future:

METTLER TOLEDO Service assures the quality, measuring accuracy and preservation of value of this product for years to come.

Please request full details about our attractive terms of service.

 [www.mt.com/service](http://www.mt.com/service)

[www.mt.com](http://www.mt.com)

For more information

**Mettler-Toledo (Changzhou) Measurement Technology Co., Ltd.**

111 Taihu West Road  
Xinbei District  
Changzhou, Jiangsu  
China, 213125  
[www.mt.com/contacts](http://www.mt.com/contacts)

Subject to technical changes.  
© 01/2024 METTLER TOLEDO. All rights reserved.  
30580443D en



30580443