

IND360

Indicator and Transmitter



IND360 Indicator and Transmitter

METTLER TOLEDO Service

Essential Services for Dependable Performance of Your IND360 Indicator and Transmitter

Congratulations on choosing the quality and precision of METTLER TOLEDO. Proper use of your new equipment according to this Manual and regular calibration and maintenance by our factory-trained service team ensures dependable and accurate operation, protecting your investment. Contact us about a service agreement tailored to your needs and budget. Further information is available at www.mt.com/service.

There are several important ways to ensure you maximize the performance of your investment:

1. Register your product: We invite you to register your product at www.mt.com/productregistration so we can contact you about enhancements, updates and important notifications concerning your product.
2. Contact METTLER TOLEDO for service: The value of a measurement is proportional to its accuracy – an out of specification scale can diminish quality, reduce profits and increase liability. Timely service from METTLER TOLEDO will ensure accuracy and optimize uptime and equipment life.
 - a. Installation, Configuration, Integration and Training: Our service representatives are factory-trained, weighing equipment experts. We make certain that your weighing equipment is ready for production in a cost effective and timely fashion and that personnel are trained for success.
 - b. Initial Calibration Documentation: The installation environment and application requirements are unique for every industrial scale so performance must be tested and certified. Our calibration services and certificates document accuracy to ensure production quality and provide a quality system record of performance.
 - c. Periodic Calibration Maintenance: A Calibration Service Agreement provides on-going confidence in your weighing process and documentation of compliance with requirements. We offer a variety of service plans that are scheduled to meet your needs and designed to fit your budget.
 - d. GWP[®] Verification: A risk-based approach for managing weighing equipment allows for control and improvement of the entire measuring process, which ensures reproducible product quality and minimizes process costs. GWP (Good Weighing Practice), the science-based standard for efficient life-cycle management of weighing equipment, gives clear answers about how to specify, calibrate and ensure accuracy of weighing equipment, independent of make or brand.

© METTLER TOLEDO 2023

No part of this manual may be reproduced or transmitted in any form or by any means, electronic or mechanical, including photocopying and recording, for any purpose without the express written permission of METTLER TOLEDO.

U.S. Government Restricted Rights: This documentation is furnished with Restricted Rights.

Copyright 2023 METTLER TOLEDO. This documentation contains proprietary information of METTLER TOLEDO. It may not be copied in whole or in part without the express written consent of METTLER TOLEDO.

COPYRIGHT

METTLER TOLEDO® is a registered trademark of Mettler-Toledo, LLC. All other brand or product names are trademarks or registered trademarks of their respective companies.

METTLER TOLEDO RESERVES THE RIGHT TO MAKE REFINEMENTS OR CHANGES WITHOUT NOTICE.

FCC Notice

This device complies with Part 15 of the FCC Rules and the Radio Interference Requirements of the Canadian Department of Communications. Operation is subject to the following conditions: (1) this device may not cause harmful interference, and (2) this device must accept any interference received, including interference that may cause undesired operation.







This equipment has been tested and found to comply with the limits for a Class A digital device, pursuant to Part 15 of FCC Rules. These limits are designed to provide reasonable protection against harmful interference when the equipment is operated in a commercial environment. This equipment generates, uses, and can radiate radio frequency energy and, if not installed and used in accordance with the instruction manual, may cause harmful interference to radio communications. Operation of this equipment in a residential area is likely to cause harmful interference in which case the user will be required to correct the interference at his or her expense.



■ Declaration of Conformity is available at
<http://glo.mt.com/global/en/home/search/compliance.html/compliance/>.

EtherCAT® is a registered trademark and patented technology, licensed by Beckhoff Automation GmbH, Germany.

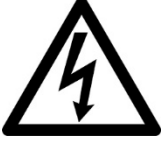
Warnings and Cautions

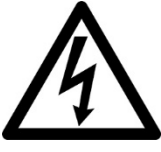
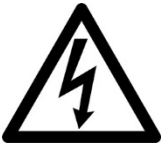
- READ this manual BEFORE operating or servicing this equipment and FOLLOW these instructions carefully.
- SAVE this manual for future reference.

	<p style="text-align: center;">⚠ CAUTION</p> <p>THE IND360 IS INTENDED TO BE USED FOR PROCESS CONTROL AND IS NOT APPROVED AS A SAFETY COMPONENT. WHEN USED AS A COMPONENT PART OF A SYSTEM, ANY SAFETY CIRCUITS MUST BE INDEPENDENT OF THE IND360 AND REMOVE POWER FROM THE IND360 OUTPUTS IN THE EVENT OF AN EMERGENCY STOP OR EMERGENCY POWER DOWN.</p>
	<p style="text-align: center;">⚠ CAUTION</p> <p>DO NOT USE IN HAZARDOUS AREAS CLASSIFIED AS DIVISION 1, ZONE 0, ZONE 20, ZONE 1 OR ZONE 21 BECAUSE OF COMBUSTIBLE OR EXPLOSIVE ATMOSPHERES. FAILURE TO COMPLY WITH THIS WARNING COULD RESULT IN BODILY HARM AND/OR PROPERTY DAMAGE.</p>
	<p style="text-align: center;">⚠ CAUTION</p> <p>NOT ALL VERSIONS OF THE IND360 ARE DESIGNED FOR USE IN HAZARDOUS (EXPLOSIVE) AREAS. REFER TO THE DATA PLATE OF THE IND360 TO DETERMINE IF A SPECIFIC TRANSMITTER DEVICE IS APPROVED FOR USE IN AN AREA CLASSIFIED AS HAZARDOUS BECAUSE OF COMBUSTIBLE OR EXPLOSIVE ATMOSPHERES.</p>
	<p style="text-align: center;">⚠ CAUTION</p> <p>DO NOT ACTIVATE POWER OVER ETHERNET (POE) ON ETHERNET SWITCHES ON THE IND360 NETWORK. ACTIVATING POE MAY RESULT IN DAMAGE TO THE IND360.</p>
	<p style="text-align: center;">⚠ WARNING</p> <p>WHEN THIS EQUIPMENT IS INCLUDED AS A COMPONENT PART OF A SYSTEM, THE RESULTING DESIGN MUST BE REVIEWED BY QUALIFIED PERSONNEL WHO ARE FAMILIAR WITH THE CONSTRUCTION AND OPERATION OF ALL COMPONENTS IN THE SYSTEM AND THE POTENTIAL HAZARDS INVOLVED. FAILURE TO OBSERVE THIS PRECAUTION COULD RESULT IN BODILY HARM AND/OR PROPERTY DAMAGE.</p>
	<p style="text-align: center;">⚠ CAUTION</p> <p>DO NOT INSTALL, DISCONNECT OR PERFORM ANY SERVICE ON THIS EQUIPMENT BEFORE POWER HAS BEEN SWITCHED OFF AND THE AREA HAS BEEN SECURED AS NON-HAZARDOUS BY PERSONNEL AUTHORIZED TO DO SO BY THE RESPONSIBLE PERSON ON-SITE.</p>
	<p style="text-align: center;">⚠ WARNING</p> <p>ONLY THE COMPONENTS SPECIFIED ON THE IND360 DOCUMENTATION CAN BE USED IN THIS INDICATOR. ALL EQUIPMENT MUST BE INSTALLED IN ACCORDANCE WITH THE INSTALLATION INSTRUCTIONS DETAILED IN THE INSTALLATION MANUAL. INCORRECT OR SUBSTITUTE COMPONENTS AND/OR DEVIATION FROM THESE INSTRUCTIONS CAN IMPAIR THE SAFETY OF THE INDICATOR AND COULD RESULT IN BODILY HARM AND/OR PROPERTY DAMAGE.</p>
	<p style="text-align: center;">⚠ WARNING</p> <p>BEFORE CONNECTING/DISCONNECTING ANY INTERNAL ELECTRONIC COMPONENTS OR INTERCONNECTING WIRING BETWEEN ELECTRONIC EQUIPMENT ALWAYS REMOVE POWER AND WAIT AT LEAST THIRTY (30) SECONDS BEFORE ANY CONNECTIONS OR DISCONNECTIONS ARE MADE. FAILURE TO OBSERVE THESE PRECAUTIONS COULD RESULT IN DAMAGE TO OR DESTRUCTION OF THE EQUIPMENT AND/OR BODILY HARM.</p>

	<p style="text-align: center;">⚠ CAUTION</p> <p>ONLY PERMIT QUALIFIED PERSONNEL TO SERVICE THE INDICATOR. EXERCISE CARE WHEN MAKING CHECKS, TESTS AND ADJUSTMENTS THAT MUST BE MADE WITH POWER ON. FAILING TO OBSERVE THESE PRECAUTIONS CAN RESULT IN BODILY HARM AND/OR PROPERTY DAMAGE.</p>
	<p style="text-align: center;"><i>NOTICE</i></p> <p>OBSERVE PRECAUTIONS FOR HANDLING ELECTROSTATIC SENSITIVE DEVICES.</p>

Disposal of Electrical and Electronic Equipment

In conformance with the European Directive 2012/19/EC on Waste Electrical and Electronic Equipment (WEEE) this device may not be disposed of in domestic waste. This also applies to countries outside the EU, per their specific requirements.



Please dispose of this product in accordance with local regulations at the collecting point specified for electrical and electronic equipment.

If you have any questions, please contact the responsible authority or the distributor from which you purchased this device.

Should this device be passed on to other parties (for private or professional use), the content of this regulation must also be related.

Thank you for your contribution to environmental protection.

Contents

1	Introduction.....	1-1
1.1.	Clarifications	1-1
1.2.	IND360 Overview	1-1
1.3.	Specifications	1-3
1.4.	Environmental Protection.....	1-5
1.5.	Inspection and Contents Checklist	1-5
1.6.	Model Identification.....	1-6
1.7.	Physical Dimensions	1-7
1.8.	Scale Types	1-9
1.9.	Main Board.....	1-10
1.10.	Options	1-11
1.11.	Front Panel	1-12
1.12.	Communication	1-14
2	Operation.....	2-1
2.1.	Overview.....	2-1
2.2.	User Security	2-1
2.3.	Understanding the HMI (Human Machine Interface)	2-5
2.4.	Weight Display	2-8
2.5.	Basic Functionality	2-8
3	Configuration	3-1
3.1.	Accessing the Web Interface	3-1
3.2.	Overview of Configuration.....	3-3
3.3.	Home	3-3
3.4.	Device	3-5
3.5.	Scale.....	3-6
3.6.	Application.....	3-33
3.7.	Terminal	3-39
3.8.	Communication.....	3-41
3.9.	Maintenance	3-56
4	Service and Maintenance	4-1
4.1.	Cleaning and General Maintenance	4-1
4.2.	Service	4-1
4.3.	Screen Saver	4-2
4.4.	Battery Replacement	4-2
4.5.	Error Management	4-3
4.6.	Alibi Log	4-11
4.7.	Maintenance Log	4-12

4.8.	Change Log	4-14
4.9.	Diagnostic Information	4-18
4.1.	Problem Diagnosis and Troubleshooting	4-19
4.2.	Master Reset	4-26
5	Parts and Accessories	5-1
5.1.	Accessories.....	5-1
5.2.	Spare parts	5-13
A.	Installation.....	A-1
A.1.	Opening and Closing Enclosures	A-1
A.2.	Mounting the Indicator	A-4
A.3.	Installing Cables and Connectors	A-13
A.4.	PCB Switch Settings.....	A-46
B.	Default Settings	B-1
B.1.	Default Parameter Settings.....	B-1
C.	TCP/IP Communication.....	C-1
C.1.	Socket Connection	C-1
C.2.	Introduction to MT-SICS Command.....	C-1
C.3.	SIX1 Command.....	C-4
C.4.	TA Command	C-5
C.5.	S Command.....	C-5
C.6.	SI Command.....	C-6
C.7.	Z Command.....	C-7
C.8.	ZI Command	C-7
C.9.	T Command.....	C-8
C.10.	TI Command.....	C-8
C.11.	TAC Command.....	C-9
C.12.	I0 Command	C-9
C.13.	I2 Command	C-10
C.14.	I3 Command	C-10
C.15.	I4 Command	C-11
D.	OPC UA Communication	D-1
D.1.	Establishing the Connection.....	D-1
D.2.	List of Nodes of IND360.....	D-3
D.3.	Troubleshooting.....	D-5
E.	REST API Communication	E-1
E.1.	Establishing the Connection.....	E-1
E.2.	Read Weighing Results	E-2
E.3.	Read Device Information	E-3

E.4.	Troubleshooting.....	E-4
F.	GEO Codes.....	F-1
F.1.	Original Site Calibration.....	F-1
F.2.	New Site GEO Code Adjustment.....	F-1

1 Introduction

The IND360 represents the latest in METTLER TOLEDO technology and is one of the fastest and most versatile automation indicators available today. Choose from different weighing technologies – conventional strain gauge, POWERCELL® or high-“precision” electromagnetic force restoration weighing technologies; specify an automation interface – PLC or PC communication, digital or analog I/O control; combine these selections in one of the three enclosure options – DIN (Omega) rail, Panel and Harsh; and the IND360 will provide information such as weight, status, and condition monitoring, to your automation system – rapidly and reliably.

1.1. Clarifications

- The IND360 is intended to be used in automation systems; therefore, please do not configure these devices for weights and measures unless you are required to for sales to consumers and local weights and measures laws. Weights and measures configuration limits flexibility and certain key functions when communicating with your automation system. For example, over and under capacity tolerances are too narrow for automated machines.
- In this guide we use the designation "d" for the minimum measurement interval which in most cases is synonymous with "e" the minimum approved (weights and measures interval). Therefore, unless noted "d" = "e".
- In this guide the word "calibration" is discussed using the English language implied meaning of "calibration and adjustment" unless otherwise noted.

1.2. IND360 Overview

Standard IND360 Features:

- Scale connection:
 - Single analog load cell scale base
 - A network of up to 8 350Ω or 20 1kΩ analog load cells
 - A network of up to 8 POWERCELL® load cells used in PowerMount™ weigh modules or PowerDeck™ scales
 - APW (Automated Precision Weighing) modules such as PBK9 and PFK9 APW versions for automation
 - High-precision platforms such as PBK9 and PFK9 Legal for Trade versions for commercial sales to the public
- Display, receipt, and transmission of information in multiple languages
- Network and system status LEDs (Red, Orange, Green)
- Legal for Trade lockout switch.

- Weighing functions e.g., zero, tare, clear
- Communication with OT (Operational Technology) system using SAI (Standard Automation Interface), supporting with certified device drivers:
 - PROFINET®
 - EtherNet/IP
 - EtherCAT®
 - CC-Link IE Field Basic
 - Profibus® DP
- Communication with OT (Operational Technology) system not using SAI (Standard Automation Interface)
 - Modbus TCP
 - Modbus RTU
- Communication with IT (Information Technology) system
 - Ethernet TCP/IP
 - OPC UA
 - REST API
- Condition Monitoring functions like Heartbeat and Smart5™ alarming
- Acyclical and Cyclical PLC messaging
- Optional analog output and solid state discrete I/O
- Webserver for local or remote parameter configuration, monitoring, backup and restore and cloning of multiple units
- OLED (DIN version) or TFT (Panel/Harsh version) display for easy local configuration
- Error log, Maintenance log, change log
- 3-level user security
- Real-time clock with battery backup
- Alibi memory storage for up to 27000 records
- Selectable electronic filtering of weight signals
- CalFree™ Adjustment of strain gauge scales without test weights
- CalFree™Plus Adjustment of POWERCELL scales without test weights
- ATEX / IECEx / FM / UKCA / NEPSI approvals (hazardous versions)

1.3. Specifications

Table 1-1: IND360 Specifications

IND360 Specifications	
Enclosure Types	<p>DIN-Rail mount, ABS plastic with automatic grounding springs at the rear side of the enclosure, the unit also includes a green plastic locking clip.</p> <p>Panel-mount stainless steel front panel with a frame which is compatible to the IND331 mounting dimensions. The panel is structured such that the electronics may be mounted with the display or may be remotely mounted on a DIN (Omega) rail with a distance of 3m (10 feet)</p> <p>Harsh environment desk/wall/column-mount type 304L stainless steel enclosure with VESA 100 mounting holes in the rear of the enclosure for mounting using optional brackets, available from METTLER TOLEDO.</p>
Dimensions w × h × d (mm/in)	<p>DIN-Rail mount: 40 x 135 x 100 / 1.6 x 5.1 x 3.9</p> <p>Panel Mount: 175 x 94 x 16 / 6.9 x 3.7 x 0.6</p> <p>Harsh Environment: 275 x 85 x 200 / 10.8 x 3.3 x 7.9</p>
Shipping Weight (kg/lb)	<p>DIN-Rail mount: 0.5 / 1.1</p> <p>Panel Mount: 1.7 / 3.7</p> <p>Harsh Environment: 3.6 / 7.9</p>
Environmental Protection	<p>DIN-Rail mount: IP20 type 1</p> <p>Panel-mount panel display: IP65</p> <p>IND360 Harsh Environment model: IP69K</p>
Operating Environment	-10° to 50° C (14° to 122° F) at 10% to 90% relative humidity, non-condensing
Legal for Trade	-10° to 40° C (14° to 104° F) at 10% to 90% relative humidity, non-condensing
Hazardous Areas	Hazardous area versions can be used for Zone 2/22, Division 2 applications
AC Input Power (Selectable only on harsh and panel-mount models)	Operates at 100–240 VAC, 49–61 Hz
DC Input Power	<p>Operates at 20–28 VDC¹; 12W²</p> <ol style="list-style-type: none"> 1. Power supply short-circuit protection time shall be equal to or longer than 100ms 2. 18W, when 5 to 8 POWERCELLs are connected
Scale Types	<p>Analog load cells: up to 8x350 Ω or 20x1000 Ω; 1~4mV/V</p> <p><i>or</i></p> <p>Up to 8 POWERCELL[®] load cells used in PowerMount[™] weigh modules or PowerDeck[™] scales</p> <p><i>or</i></p> <p>APW (Automated Precision Weighing) modules and high-precision APW platforms suited to automation or high-precision platforms that are suitable for legal for trade including Advanced Setup Mode</p>

IND360 Specifications	
Analog Load Cell Excitation Voltage	5 VDC
Automation interface Update Rate	IND360 analog: 960 Hz IND360 POWERCELL: 100Hz for 1~4 LCs; 50 for 4~8 LCs IND360 Precision: 92 Hz
Display	DIN-Rail mount version: 1.04" green OLED Panel mount version: 4.3" color TFT Harsh version: 4.3" color TFT
Keypad	DIN-Rail mount version: 4 keys (Up, Down, Left, Enter); 0.9 mm thick polyester overlay (PET) with 0.178mm thick polycarbonate display lens Panel mount and harsh version: 5 keys (Up, Down, Left, Right, Enter); 0.9 mm thick polyester overlay (PET) with 0.178mm thick polycarbonate display lens
Communication	<p>Standard Interfaces</p> <p>Ethernet Port: Ethernet TCP/IP interface for service setup (web interface), basic control from PC – refer to Appendix C for details, and REST API function (preview version)</p> <p>Optional Automation Interfaces (none or one of the following)</p> <p>Industrial Ethernet Port for PROFINET, EtherNet/IP, EtherCAT, CC-Link IE Field Basic and Modbus TCP, which also support Media Ring Profile (PROFINET) and Device Level Ring (EtherNet/IP)</p> <p>Industrial Ethernet Port as above and OPC UA in addition</p> <p>Interface for Profibus DP communication</p> <p>Interface for Modbus RTU communication</p> <p>Optional Analog and Digital IOs (none or one of the following)</p> <p>4~20mA/0~10V Analog Output</p> <p>4~20mA/0~10V Analog Output, 3 Discrete Inputs, 4 Discrete outputs, Solid State</p> <p>5 Discrete Inputs, 8 Discrete Outputs, Solid State</p>
Approvals	<p>Weights and Measures</p> <p>IND360 Analog and IND360 POWERCELL</p> <p>Europe: Class III T11060 TC11949</p> <p>USA: Class III / III L n max. 10,000 CC No. 21-002</p> <p>Canada: Class III / III HD n max. 10,000 AM-6161</p> <p>China: Class III n max. 10,000</p> <p>IND360 Precision</p> <p>Europe: Class II TC11949 T11060</p> <p>USA: Class II / III / III L n max. 100,000/10,000 CC No. 21-002</p> <p>Canada: Class II / III / III HD n max. 100,000/10,000 AM-6161</p> <p>Product Safety</p> <p>UL, cUL, CE, UKCA, FCC, CB</p> <p>Hazardous</p> <p>Zone 2/22, Division 2 approvals at ATEX / IECEx / FM / UKCA. Refer to the datasheets for details.</p>

1.4. Environmental Protection

	CAUTION
	DO NOT USE IN HAZARDOUS AREAS CLASSIFIED AS DIVISION 1, ZONE 0, ZONE 20, ZONE 1 OR ZONE 21 BECAUSE OF COMBUSTIBLE OR EXPLOSIVE ATMOSPHERES. FAILURE TO COMPLY WITH THIS WARNING COULD RESULT IN BODILY HARM AND/OR PROPERTY DAMAGE.

1.5. Inspection and Contents Checklist

Verify the contents and inspect the package immediately upon delivery. If the shipping container is damaged, check for internal damage and file a freight claim with the carrier if necessary. If the container is not damaged, remove the IND360 indicator from its protective package, noting how it was packed, and inspect each component for damage. If the unit is damaged, do not apply power and contact your local METTLER TOLEDO representative. Take a picture if possible if the unit is damaged for evidentiary purposes. The packaging material has been selected for the lowest environmental impact and may be recycled.

If it is necessary to reship the indicator, it is best to use the original shipping container. The IND360 indicator must be packed correctly to ensure its safe transportation.

Please read the safety instructions before using this device.

A QR code on the data label will direct you to additional documentation.

The package should include:

- IND360 indicator
- Safety warnings in multiple languages
- CE Declaration of Conformity (Europe only)
- Bag of parts for installation. Depending on indicator type, may include ferrites, grommets, rubber feet, sealing gasket, tools etc.

1.6. Model Identification

The IND360 model number is located on the data plate on the indicator along with the serial number and SCK (configuration number). Figure 1-1 shows the SCK of the IND360 indicator.

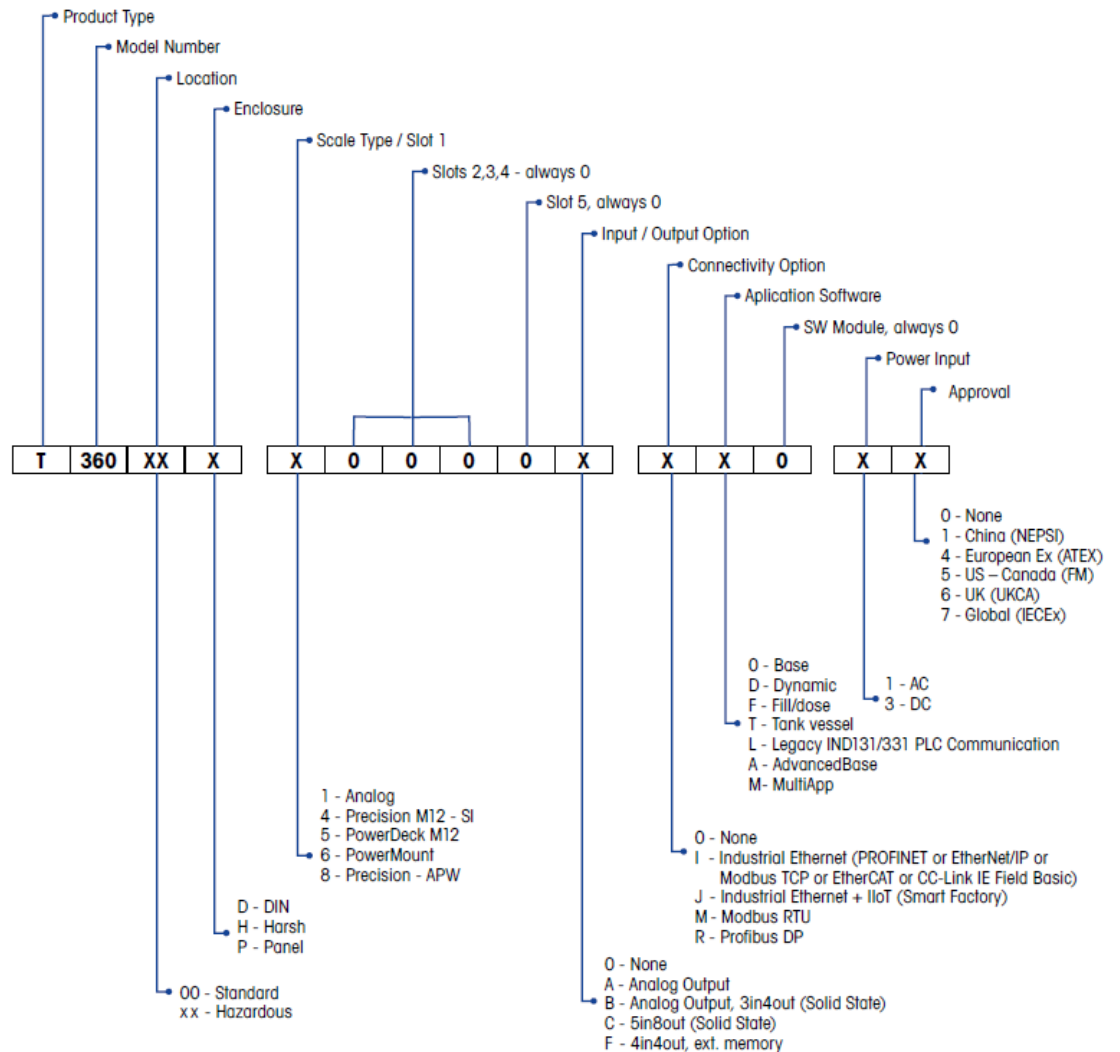

Figure 1-1: IND360 SCK Identification

1.7. Physical Dimensions

1.7.1. IND360 DIN-Rail Mount

The physical dimensions of the IND360 DIN-Rail mount enclosures are 40 mm x 135 mm x 100 mm (1.6 in x 5.1 in x 3.9 in). The automatic grounding of this device is at the rear of the enclosure.

Please note that this style is intended to be located in an enclosure providing suitable environmental protections from water, dust, humidity and excessive heat that exceeds the device's operating specifications. Ensure that adequate ventilation is available inside the control enclosure.



Figure 1-2: IND360 DIN-Rail Mount Dimensions

1.7.2. IND360 Panel Mount

The IND360 Panel Mount consists of following:

- A panel with display and keypad
- An IND360 DIN-Rail mount module (without the OLED display)
- An optional power supply module, which has the same dimensions as the IND360 DIN-Rail mount module.

The physical dimensions of the IND360 Panel are 175mm x 94mm x 17mm (6.9 in x 3.7 in x 0.6 in).

- Note the panel is constructed such that the unit will fit the hole pattern of the METTLER TOLEDO Model IND331. Also note that the display itself is slightly larger than that of the IND331.



Figure 1-3: IND360 Panel Mount Dimensions

Figure 1-4 shows the dimensions of the holes required for the Panel Mount display.

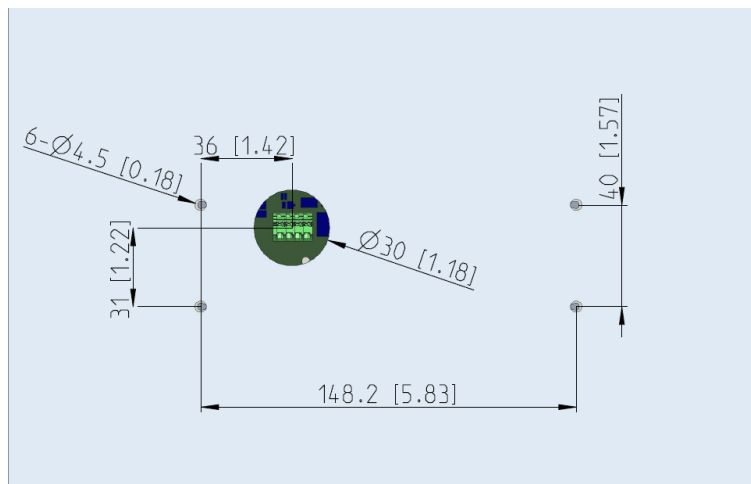

Figure 1-4: IND360 Panel Mount Cutout Dimensions

The IND360 electronics enclosure and the 24V power supply module may be either mounted directly on the DIN-Rail behind the panel as shown in Figure 1-3, or mounted elsewhere and connect to the panel with a cable.

1.7.3. IND360 Harsh Environment Mount

The physical dimensions of the IND360 harsh environment mount enclosures are 275 mm x 85 mm x 200 mm (10.8 in x 3.3 in x 7.9 in).

This enclosure may be placed on a desk, mounted on the wall, or on the standard column of a METTLER TOLEDO bench or floor scale. The front cover may be rotated 180° to allow the cables to exit the rear of the enclosure when placed on a desk or under the enclosure when mounted on the wall or column.

There are four VESA 100 mounting holes at the rear of the enclosure allowing you to use commonly available METTLER TOLEDO brackets such as part number 30462051 for desk and wall mount and part number 22020286 for column mount, or commercially available VESA 100 components.

- Note. The mounting holes are not compatible with those used for the METTLER TOLEDO IND331.

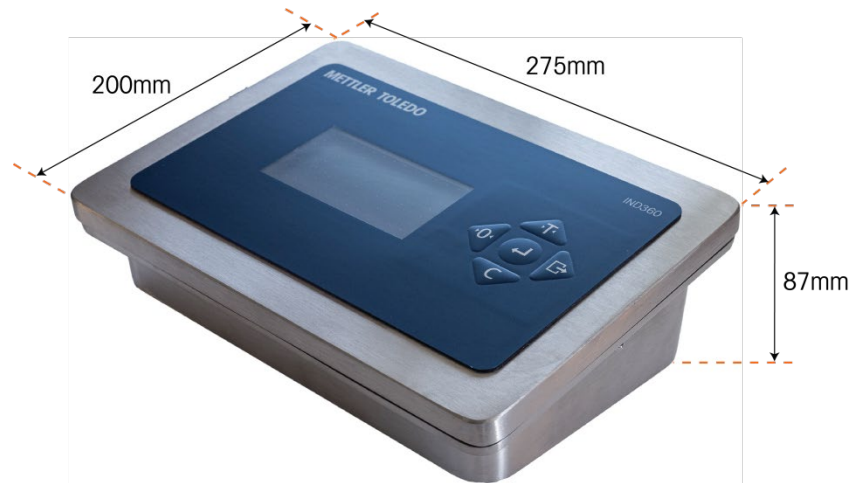

Figure 1-5: IND360 Harsh Mount Dimensions

1.8. Scale Types

The IND360 supports several types of scales. These are detailed in the following sections.

1.8.1. Analog Load Cell Scales

The IND360 Analog version includes an analog (Strain Gauge) load cell interface. The indicator can drive 8x350 Ω or 20x1000 Ω analog load cells with 1~4mV/V output allowing the device to be used with both new and existing scales.

1.8.2. APW (Automated Precision Weighing) Modules and High-Precision Platforms

The IND360 Precision version has an interface to one APW (Automated Precision Weighing) module or one high-precision platform. The Table 1-2 lists how various functions are supported when different types of weigh modules or scales are connected.

Table 1-2: Supported APW Modules and High Precision Platforms

	Precision Scales for Legal for Trade	Precision Scales for Automation
Compatible Modules	PBD555 / PBD769 / PBD655 / PBD659 / PBK785 / PBK9 / PTA4XX / PFA5XX / PUA5XX / PFA779lift / PFK9	WKC / WMS / WXS / SLF6 / PBK989-APW / PFK989-APW
Basic Functions (Read weight and status, tare, zero, clear)	Display/keypad	Display/keypad
	Web interface	Web interface
	Automation interface	Automation interface
Parameter configuration (Calibration, adjustment, filter parameters, ...)	Display/keypad (Panel and Harsh)	Display/keypad
	Web interface (DIN, Panel and Harsh)	Software tool: APW-Link Automation interface ¹
Firmware upgrade for precision modules	Software tool: eLoader	Software tool: eLoader

¹ Each weigh module supports different functions. Please consult the SAI (Standard Automation Interface) manual for further details.

1.8.3. POWERCELL Scale Platform

The IND360 POWERCELL version includes a POWERCELL load cell interface. The indicator can drive up to 8 POWERCELL load cells. If more than eight load cells are needed, IND570 or IND780 PDX indicators must be used.

1.9. Main Board

The IND360 indicator's main printed circuit board (PCB) provides the interface for analog scales/load cell(s), or POWERCELL load cells, or APW (Automated Precision Weighing) modules and high-precision platforms.

An Ethernet Port is located on the Main PCB, which enables Ethernet TCP/IP communication for service setup (web interface) and basic control from PC – read weight, zero, tare and clear operations.

The main board also contains an input from the power supply, front panel keypad interface and bus connectors for the option boards.

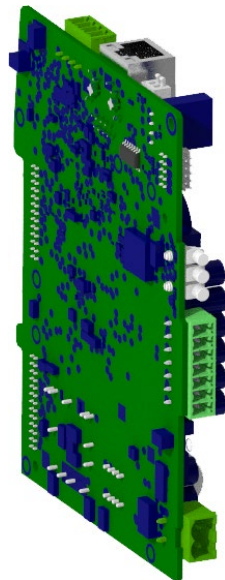

Analog scales/load cells/weigh modules

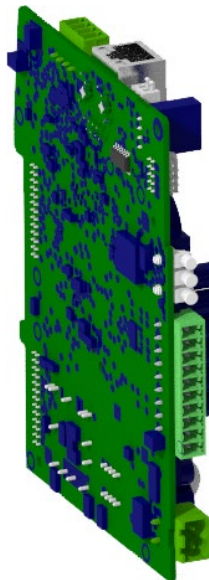

APW (Automated Precision Weighing) modules and high-precision platforms

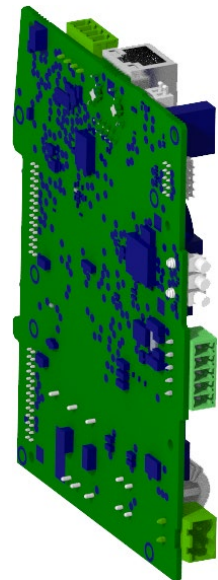

POWERCELL load cells

Figure 1-6: IND360 Main PCBs

1.10. Options

The following hardware options are available for the IND360 there are slots available for two types of option boards: I/O boards and automation interface boards.

1.10.1. I/O Boards

The IND360 offers the following three I/O options. Note that only one of these may be selected:

- 4~20mA/0~10V analog output
- 4~20mA/0~10V analog output, 3 DIs, 4 DOs, Solid State
- 5 DIs, 8 DOs, Solid State
- 5 DIs, 8 DOs, Solid State, extended memory (for dynamic application)

			
4~20mA/0~10V analog output	4~20mA/0~10V analog output, 3 DIs, 4 DOs, Solid State	5 DIs, 8 DOs, Solid State	5 DIs, 8 DOs, Solid State, extended memory

Figure 1-7: IND360 I/O Options

1.10.2. Automation Boards

The IND360 offers the following three Automation (PLC/DCS) interfaces. Note that only one of these may be selected:

- Industrial Ethernet Port for PROFINET, EtherNet/IP, EtherCAT, CC-Link IE Field Basic, Modbus TCP and OPC UA
- Interface for PROFIBUS DP communication
- Interface for Modbus RTU communication

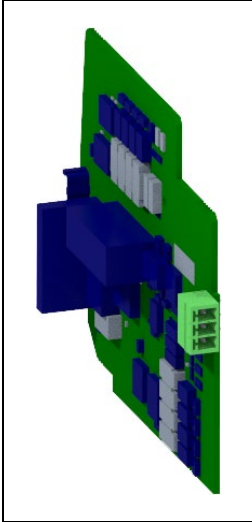
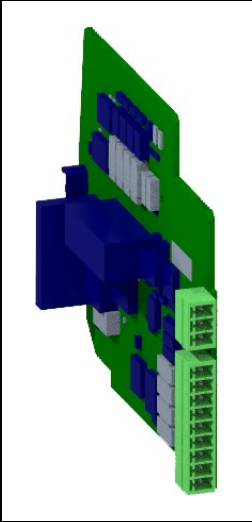
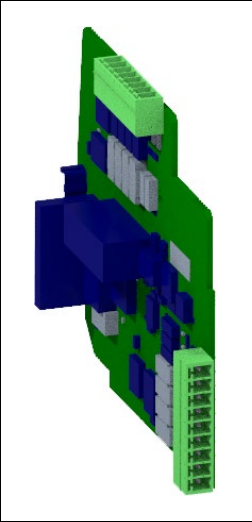
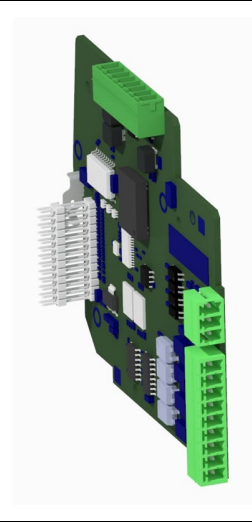
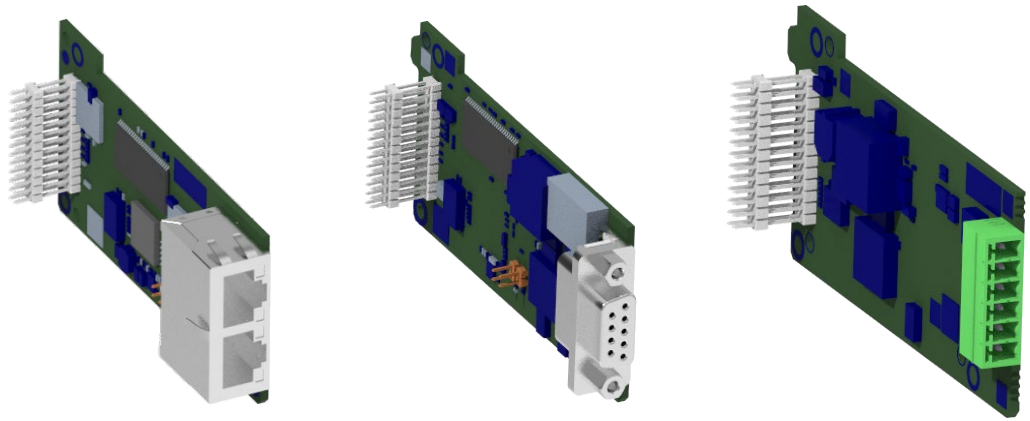

Interface board, Industrial Ethernet (PROFINET, EtherNet/IP, EtherCAT, CC-Link IE Field Basic, Modbus TCP) and OPC UA

Interface board, Profibus DP with vertical header

Interface board, Modbus RTU

Figure 1-8: IND360 Automation Options

1.11. Front Panel

1.11.1. DIN-Rail Mount Version

The IND360 DIN-rail mount version has a 1.04" organic LED (OLED) display, four navigation keys, status indicators and connectors. An example is shown in Figure 1-9, Figure 1-10 and Figure 1-11.

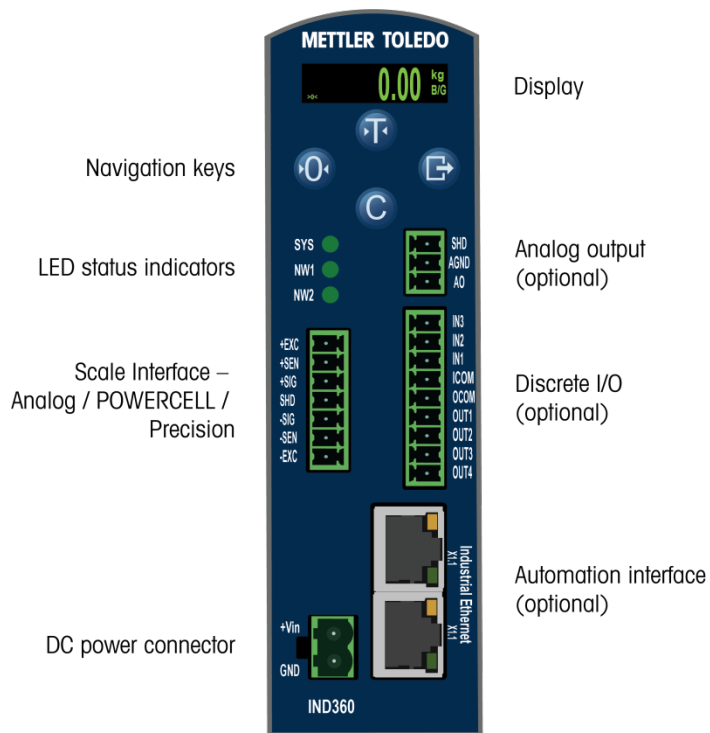

Figure 1-9: Example of IND360 DIN-Rail Mount Front Panel Layout

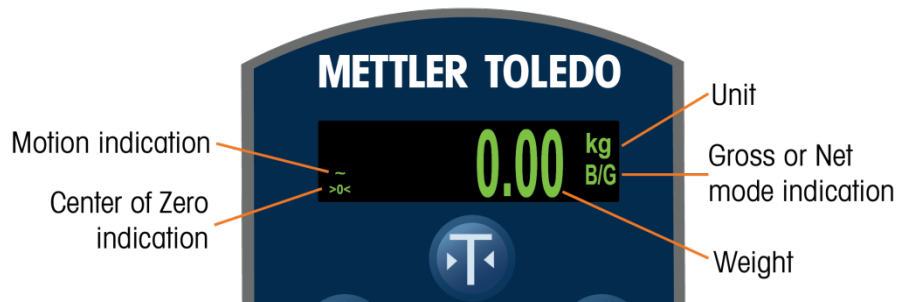

Figure 1-10: IND360 DIN-Rail Mount Display

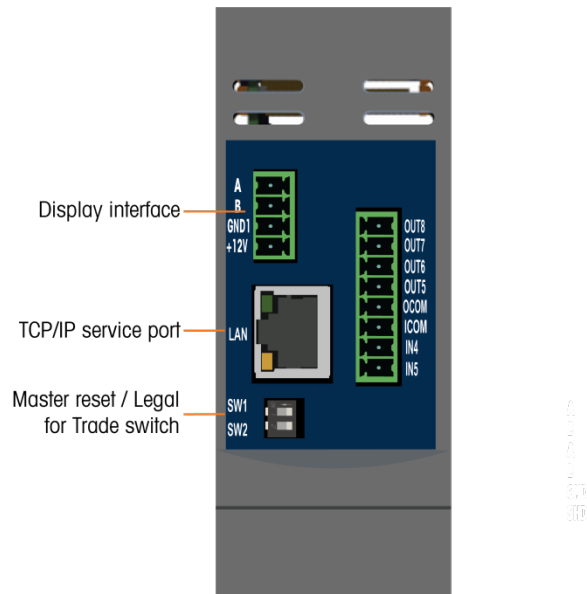

Figure 1-11: IND360 DIN-Rail Mount Top Layout Example

1.11.2. Panel Mount Version

The Panel mount version includes a 4.3" color TFT display and five navigation keys.



Figure 1-12: IND360 Panel Mount Front Panel Layout

- A real time clock shows the current time.
- A metrology line is designed to show the capacity and increment size information for the scale.
- The system line displays the IP address of the device
- The middle portion of the display is reserved for the weight display.

- The Tare display shows the current Tare value.
- The Legend display area provides the user with current operational information such as center of zero status, gross or net mode, etc.
- The very bottom of the physical display area is reserved for showing the graphic labels (icons) for the softkeys.
- The Smart5™ condition monitoring indicates the system status with icons in 5 different colors, which requires different reactions. Alarm information is locally displayed and provided to automation system

1.11.3. Harsh Environment Version

The harsh environment mount version has the same display and keypad layout as the panel mount.

1.12. Communication

1.12.1. Supported Communication Types

The IND360 supports data transfer via following interfaces:

- Service port
 - for device configuration and firmware upgrade using webserver (refer to Chapter 3, Configuration)
 - for ePrinting (refer to Chapter 2, Operation)
 - for external weight display and simple control (refer to Appendix C, TCP/IP Communication)
 - for weight, status, device information query using JSON REST API (preview version, refer to appendix F)
- Optional automation interfaces
 - for integrating IND360 into the PLC/DCS systems (refer to the PLC manual/SAI manual)
 - for integrating IND360 into PC/Server/ERP systems using OPC UA (refer to appendix E)
- Optional analog output and discrete I/O ports to provide weight and status information to external devices/systems

1.12.2. Communication Interface Layout

An example of the communication interface layout of IND360 DIN-Rail mount version is shown in Figure 1-13. The panel mount version has the same communication interface layout.

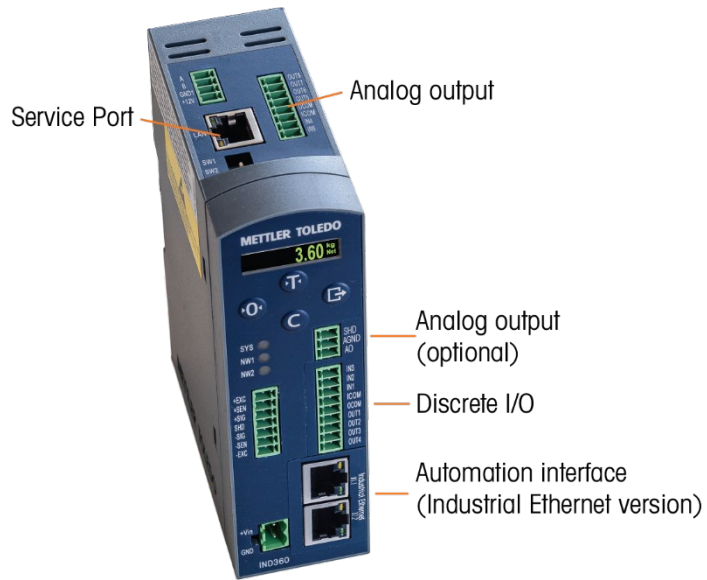

Figure 1-13: Example of Communication Interfaces on IND360 DIN-Rail Version

The communication interface layout of IND360 harsh environment mount version is shown in Figure 1-14.

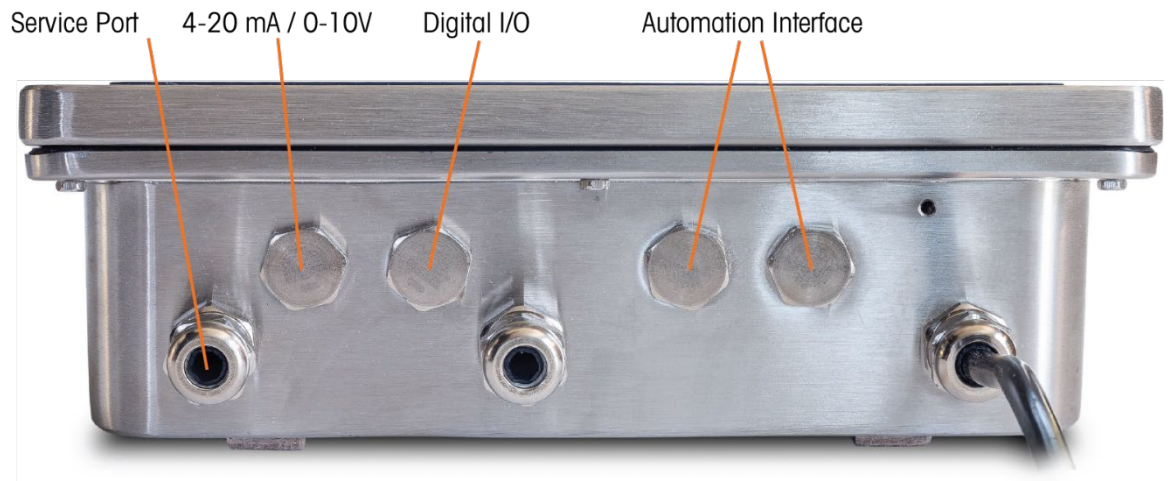

Figure 1-14: Communication Interfaces on IND360 Harsh Environment Version

2 Operation

2.1. Overview

This chapter provides information about navigation, basic features and functions used when operating the IND360 automation indicator.

Specific operation of each IND360 indicator depends on enabled functions and parameters configured in setup. Individual setup parameters are described in Chapter 3, **Configuration**. Configuration and operation of some of the more complex indicator applications are further detailed in the dedicated application manuals for the IND360.

2.2. User Security

It is often required that equipment access or use be limited according to the security clearance of the user. These limitations may be due to legal regulations or customer preference. Some installations operate in a “trusted” environment, where security is managed within the scope of the operation perimeter and no additional security is required from the automation indicator. The opposite extreme may be found in highly regulated industries where every operation must be recorded and authorized by signature or login.

- The IND360 supports three levels of user security that rely on appropriate username/password entry for access to setup and indicator functions accessible from the home screen.

Admin	An Administrator has unlimited access to all areas of the operating and setup system. At the factory, the indicator is configured with a Primary Administrator account with a username of admin. The factory default password is null (no password). This account's username cannot be changed, but a password can be added or modified. As configured at the factory, the indicator requires no login or password entry to access setup mode. All functions of the indicator are available to all users until a password is programmed for the Primary Administrator account.
Supervisor	Parameters in the Scale , Indicator and Communication menus are read-only. Parameters in menu Application and Maintenance are accessible without limitation.
Operator	Settings are read-only for the operator

- When setting a password for a user, be sure to remember it and protect it from access by unauthorized personnel. If the password is changed or forgotten, access to the setup menu and some indicator functions will be lost. To regain access and functionality, a master reset of the indicator must be performed. This will reset all username and passwords, but also remove any custom configuration.

2.2.1. Legal Metrology Switch

If the legal metrology switch (SW1-1) is placed in the approved (ON) position, access to the Scale branch of setup and to other legal metrologically significant areas is not permitted. The legal metrology switch can be used to prevent Admin level users from accessing legal metrology features even if the region approval is "None".

- The Legal Metrology switch shall be enabled only when the system is used in commercial trade with the public, or when specifically required by law. Enabling this switch will cause undesirable behavior when the IND360 is used in an automation system.
- When analog load cells are used, the connecting cable of the load cell or the junction box includes sealing capability. Sealing material for the IND360 DIN and Panel versions is included in the delivery package. Use 30130836 to seal the Harsh version.

When a high precision platform is connected, the IND360 stores the connected platform's ID number and the number of its event counter. Access to these parameters is protected by the security switch SW1-1 inside the instrument enclosure. It is not necessary to seal the connection cable; if the paring is broken, the IND360 will report "Approval is invalid".

When POWERCELL load cells or PowerDeck™ scales are connected, the sealing is performed at IND360 where the load cell serial numbers are stored. It is not necessary to seal the connection cables. If the load cell serial number is not the same as the number detected in the approved mode, the IND360 will report "Approval is invalid".

- For OIML, set the following parameters before enabling the legal metrology switch:

Scale > Zero & Tare > Ranges > Power up zero	Use calibrated zero
Scale > Zero & Tare > AZM & Display > Under zero blanking	20 d
Scale > Zero & Tare > AZM & Display > Auto zero range	0.5 d
Scale > Capacity & Increment > Blank over capacity	9 d
- When precision scales for Legal-for-Trade is used in class II, activate the fully automated calibration function (FACT). Other parameters such as temperature and time shall be setup based on the actual requirement. Please refer to the scale manual regarding the menu structure for these parameters.

Selecting a specific region approval and setting the Metrology switch to ON alters some scale functions:

- If the approval is Canada, the indicator's functions are changed as follows:
 1. The keyboard tare command carries out a rounded tare.
 2. The center of zero division is 0.2d. The default value for non-approved mode is 0.25d.
- If the approval is OIML, then the pushbutton zero range is +/-2%. For non-approved mode, this range can be selected by the user.

Access to the metrology switch may be sealed in conformity with local regulations in "legal-for-trade" applications. Figure 2-1 shows the location of the metrology switch.

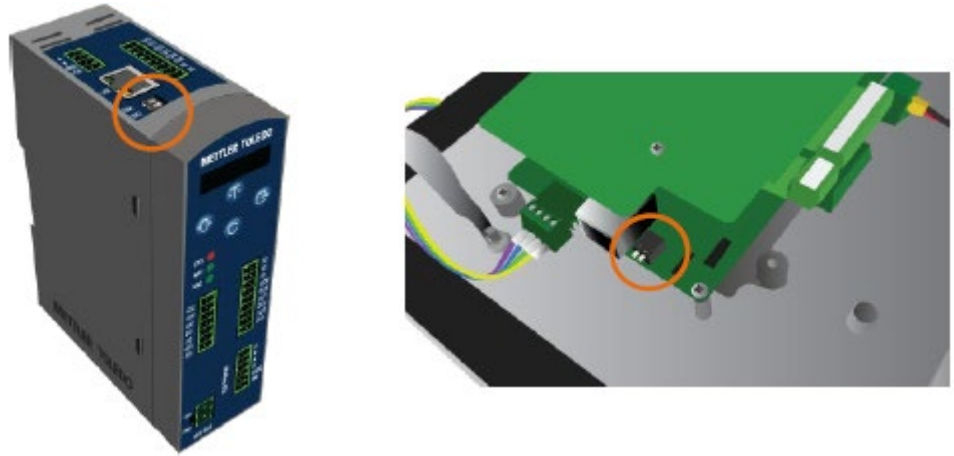
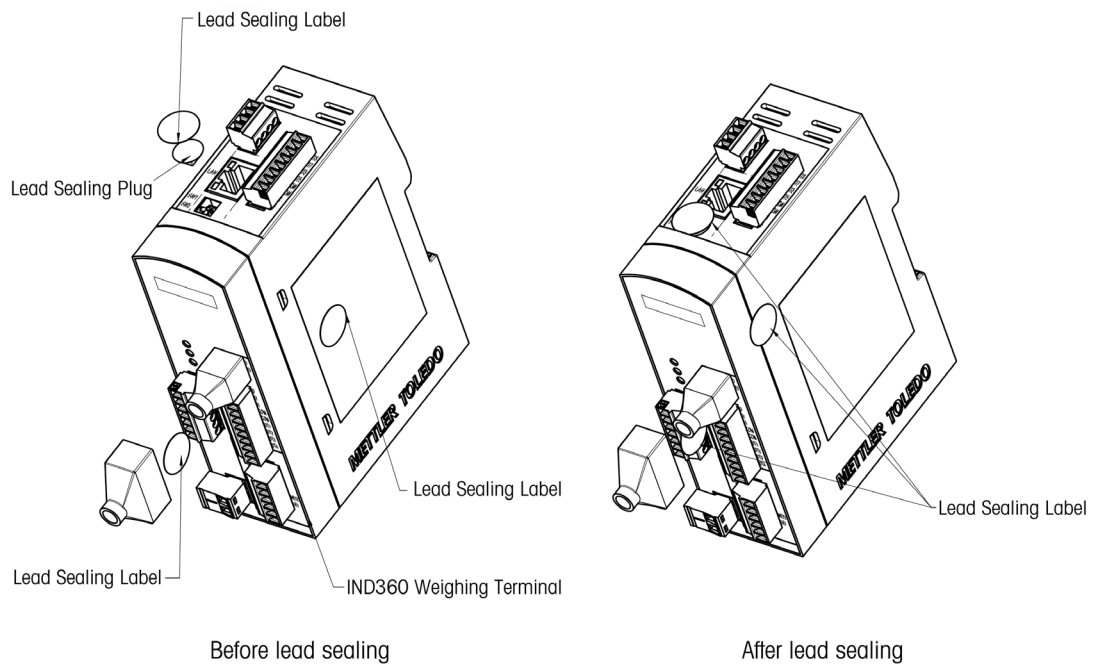

Figure 2-1: Metrology Switch Location

- Refer to Section A.4, PCB Switch Settings, in Appendix A, Installation, for further information about SW1-1 and SW1-2 switch settings.

2.2.2. Metrological Sealing Drawings

2.2.2.1. IND360 DIN Sealing



2.2.2.2. IND360 Panel Sealing

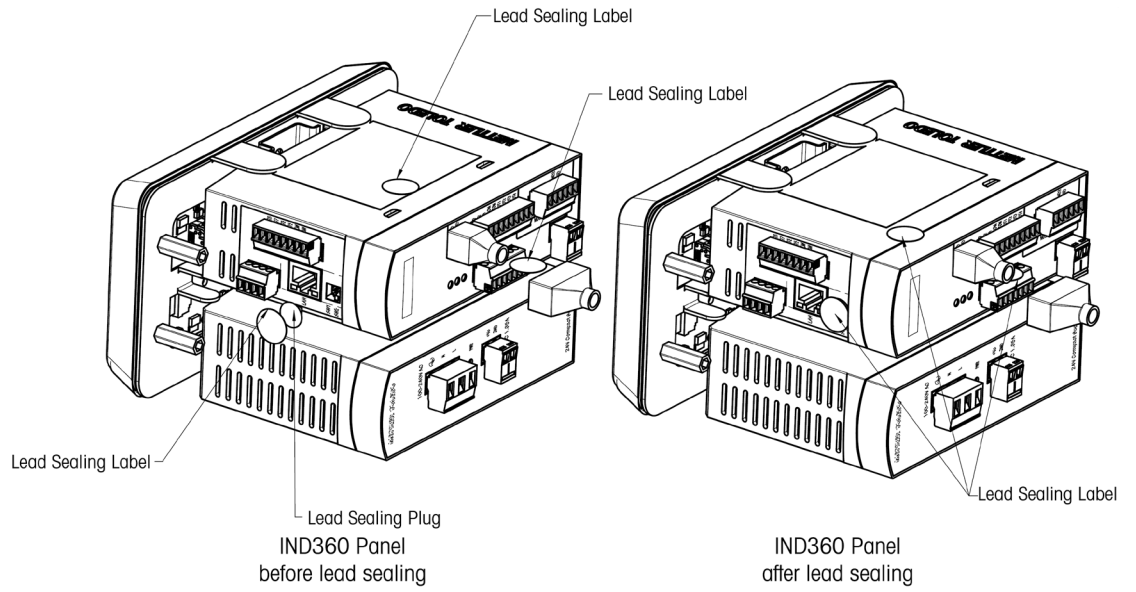

2.2.2.3. IND360 Harsh Sealing

2.2.2.3.1. Paper Seal

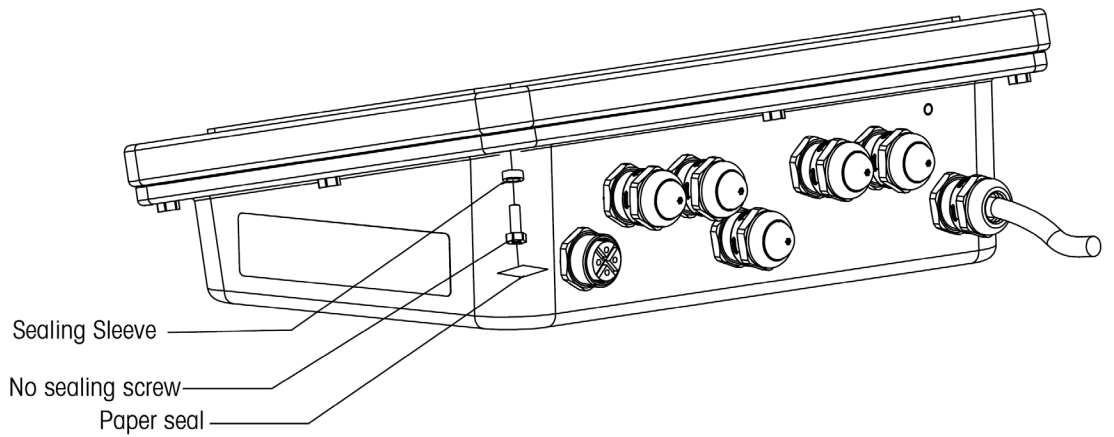

2.2.2.3.2. Wire Seal

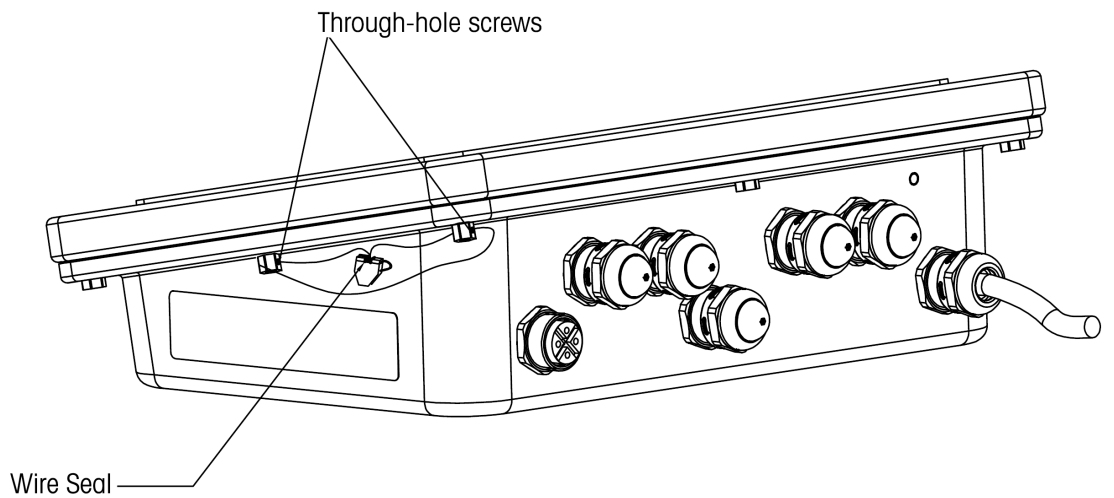

2.3. Understanding the HMI (Human Machine Interface)

The locations of the keys and the display screen area are shown in Figure 2-2. For information on how to access the built-in web interface of the IND360, refer to Chapter 3, Configuration.

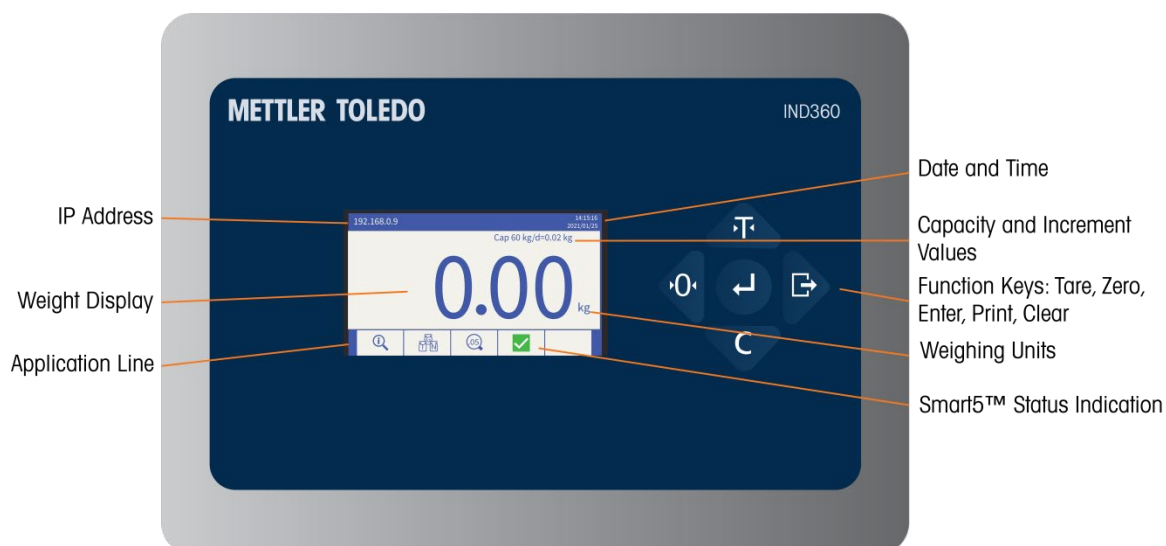

Figure 2-2: Key Locations and Display Screen for Harsh Version

2.3.1. Navigation Keys for DIN Mount Unit

Navigation keys (Figure 2-3) enable navigation within the setup menu. When not in the setup menu, each key acts as a scale function key, as explained below for the DIN mount IND360.

Figure 2-3 Setting Numerical Values for DIN mount IND360

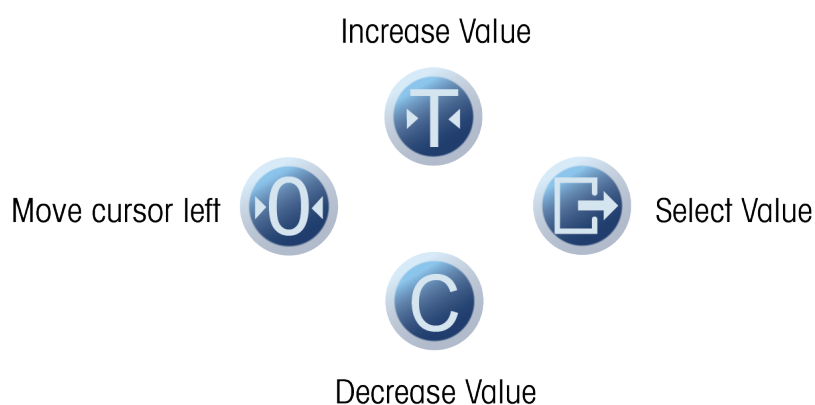

Table 2-1: Keypad for DIN mount IND360

Key	Name	Normal Operation	Setup Menu	Numerical Values	List Selection
	Tare	Tare	Up	Increase value	Previous item above
	Zero	Zero	Back / Exit	Select digit to the left	Exit parameter selection
	Clear	Clear	Down	Decrease value	Next item below

Key	Name	Normal Operation	Setup Menu	Numerical Values	List Selection
	ePrint/Setup	ePrint (short press) Enter setup (long press)	Confirm selection or enter parameter selection	Select digit to the right	Accept

- Tare allows the operator or control system to subtract the weight of an empty container from the displayed weight. Do not use the zero function for this purpose. Refer to section 2.3.4 or 2.5.2 for details.

2.3.2. Navigation Keys for Panel Mount and Harsh Units

Figure 2-4: Navigation Keys, Harsh and Panel IND360

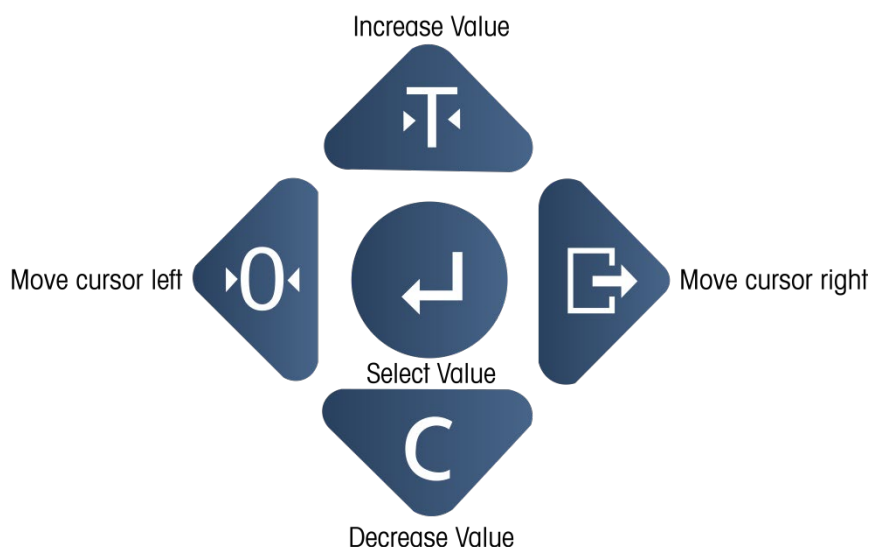

Table 2-2: Keypad for Harsh and Panel IND360









Key	Name	Normal Operation	Setup Menu	Numerical Values	List Selection
	Tare	Tare	Up	Increase value	Previous item above
	Zero	Zero	Back / Exit	Select digit to the left	Exit parameter selection
	Clear	Clear	Down	Decrease value	Next item below
	ePrint/Setup	ePrint (short press) Enter setup (long press)	(No function)	Select digit to the right	(No function)
	Enter	Confirm selection	Enter to parameter selection / setup	Accept	Accept

- Tare allows the operator or control system to subtract the weight of an empty container from the displayed weight. Do not use the zero function for this purpose. Refer to section 2.3.4 or 2.5.2 for details.

2.3.3. Menu Icons

A long press of the ENTER key enters the device menu. Chapter 3, Configuration, provides further detail on the elements of the menu. Table 2-3 lists the menu icons and their functions.

Table 2-3: Icons and Functions

Icon	Function	Icon	Function
	Information Recall		Warnings and Alarms
	Times 10 Display (expands the displayed weight by 10)		Scale Setup
	Application		Indicator
	Communication		Maintenance

2.3.4. Scale Function Keys

The keys on the front of the IND360 act as scale function keys when the indicator display is not showing the device menu. These same functions can be executed via the web interface, a configured input or a PLC. The scale function keys, indicated in Figure 2-2, are:

- 

ZERO When the scale platform is empty, the indicator should indicate zero. The gross zero reference is recorded during calibration. Press the ZERO scale function key to capture a new gross zero reference point if pushbutton zero is enabled in configuration and the weight is within the zero range.
- 

TARE Tare is the weight of an empty container. Tare is normally used to determine the net weight of the contents of a container. Press the TARE scale function key when an empty container is on the scale. The indicator then displays a zero net weight. As the container is loaded, the indicator then displays the net weight of the contents. Pushbutton tare must be enabled to use this key in this manner.
- 

CLEAR When in net weight mode, press CLEAR to clear the current tare value; the display will revert to the gross weight value. CLEAR executes regardless of motion on the scale. Note that once the tare value has been cleared, it cannot be recalled. The complete tare process as described above must be performed.
- 

ePRINT Press to trigger an ePrint of the weight value. The message is sent via TCP/IP default port 1025 using the service Ethernet port, if the ePrint function is enabled.

2.4. Weight Display

The Weight Display screen is reserved for scale weight, units, Net/Gross indicator and error messages. Figure 2-5 shows a sample weight display.



Figure 2-5: Default Home Screen, Panel and Harsh IND360

The Weight Display can include*:

Weight Unit	Primary unit for the scale
Motion Indication	Based on the stability criteria for the scale, a motion condition has been detected
Center of Zero	Center of Zero has been achieved
Gross or Net Mode	Indicates whether the displayed weight is gross weight or net weight
Capacity	User programmed capacity for the scale in primary unit
Increment	The size of display divisions in primary unit
Service IP Address	IP address used to access the web interface of the IND360 via the service port

* Not all possible Home screen functions and display items are listed.

2.5. Basic Functionality

This section provides information about the IND360 basic functionality. Additional areas of functionality specific to application software available for the IND360 are addressed in the specific application manuals.

For details on activating some of the more complex functions of IND360, please refer to Chapter 3, Configuration, and the dedicated application manuals.

2.5.1. Zero

The Zero function is used to set or reset the initial zero reference point of the IND360. There are three types of zero setting modes:

- Automatic Zero Maintenance
- Power-Up
- Pushbutton

2.5.1.1. Automatic Zero Maintenance

Automatic Zero Maintenance (AZM) enables the IND360 to compensate for the buildup of small amounts of weight (such as snow or rain) and track itself back to the center of zero. Within the AZM operating range (programmable from 0.1 to 9.9 divisions), when the indicator is in a no motion condition, it makes small adjustments to the current zero reading to drive the weight reading toward the true center-of-zero. When the weight is outside of the programmed AZM range, this feature is not functional.

2.5.1.2. Power-Up Zero

Power-Up Zero enables the IND360 automation indicator to capture a new zero reference point after power is applied. If the indicator detects motion during a power-up zero capture function, it will continue to check for a no-motion condition until zero is captured.

At power-up, the zero reference can either be the last calibrated zero, the last zero used before the device powered down (this could include slight adjustments from the calibrated zero), or a new captured zero. The new captured zero acceptable range above and below calibrated zero can be configured. The range is programmable from 0% to 100% of capacity and can include a positive range and a range below calibrated zero.

- Note that in some applications/workplaces the Powerup Zero may create undesirable behavior. In a tank system, the "capture new zero" option shall not be selected or the range set to a low percentage. A high value will eliminate the weight of the contents of the tank.

2.5.1.3. Pushbutton Zero

The pushbutton (semi-automatic) zero function can be accomplished by:

- Pressing the ZERO  scale function key
- Web interface command
- Assigning a discrete input for zero and then activating this discrete input
- PLC/DCS command to the IND360
- TCP/IP command to the IND360

The range for all types of semi-automatic zero is selectable (0% to 100%) plus or minus from either the calibrated zero point (if power-up zero is disabled) or from the initial zero setting point (if power-up zero is enabled).

- Note that both the zero and tare functions are blocked by the customer-adjustable motion/stability detector, which prevents these events when the scale is not stable. The PLC/DCS must use "zero immediate" to prevent delays due to motion.

2.5.2. Tare

Tare is the weight of an empty container. A tare value is subtracted from the gross weight measurement, providing a net weight (material without the container). The tare function can also be used to track the net amount of material being added to or removed from a vessel or container. In this second case, the existing weight of the material in the container is included

with the weight of the container as the tare weight. The display then reflects the net amount being added to or removed from the vessel.

2.5.2.1. Pushbutton Tare

Pushbutton tare can be configured in setup as enabled or disabled. When disabled, the TARE scale function key  cannot be used to obtain a tare.

If enabled, pressing the pushbutton TARE scale function key  initiates a semi-automatic tare. The IND360 will attempt to perform a tare process. If successful, the display changes to a zero net weight indication and the previous weight on the scale is stored as the tare value. The net mode will be indicated on the display.

- Note that both the zero and tare functions are blocked by the customer-adjustable motion/stability detector, which prevents these events when the scale is not stable. The PLC/DCS must use “zero immediate” to prevent delays due to motion.

Several conditions could prevent the pushbutton tare function from working:

Motion	Pushbutton tare cannot be taken when the scale is in motion. If motion is detected when a pushbutton tare command is received, the IND360 will wait up to three seconds (default value) for a no-motion condition. If a stable (no-motion) weight condition occurs before the three second timeout (default value) expires, the pushbutton tare command is executed. If there is still motion at the end of timeout period, the command is aborted and a “Tare Failed–Motion” error displays.
Pushbutton Tare Disabled	If pushbutton tare is configured as disabled, the TARE scale function key will not initiate a semi-automatic tare.

2.5.2.2. Preset Tare

A preset tare is a numeric tare value that is entered manually. The preset tare value cannot exceed the capacity of the scale. A manually entered Tare value is interpreted to have the same units as the current displayed value. Motion does not impact the entry of preset tare values.

Preset tare can be configured in setup as enabled or disabled.

The preset tare function can be executed via the web interface or PLC command.

If the preset tare is successful, the display changes to a net weight indication, and the entered preset tare value is stored as the tare weight value.

Several conditions could inhibit the preset tare function:

Preset Tare Disabled	If preset tare is disabled in setup, a preset tare executed via the web interface cannot be used to obtain a tare.
Over-Capacity or Under-Zero Conditions	Preset tare is not allowed when the weight display indicates over capacity or under zero conditions. Any preset tare attempted when the scale is over capacity is ignored and a “Tare Failed–Over Capacity” error displays. Any preset tare attempted when the weight display indicates a blanked under zero condition is ignored and a “Tare Failed–Below Zero” error displays.

If a preset tare has already been established and another preset tare is entered, the second preset tare replaces the previous value (it does not add to the previous value). The replacement tare can be larger or smaller than the original tare value.

2.5.2.3. Clearing Tare

Manually clear tare values by pressing the CLEAR function key  when the IND360 is in the net mode and has completed the weighing operation. Motion on the scale will not impact a manual clear. Clear tare can also be performed via the web interface or PLC/DCS.

2.5.3. Expand By 10

The EXPAND BY 10 option is used to increase the selected weight display resolution by one additional digit. For example, a weight display of 40.96 could increase by one additional digit to display as 40.958. The Expand By Ten mode is indicated on the display by x10. When the expand by ten mode is indicated on the display the  key can be used to exit the mode and revert to the normal weight display.

If the indicator is programmed as approved with the metrology switch (SW1-1) ON, the Expand By Ten mode is displayed for five seconds then automatically returns to normal resolution.

This expansion is used when performing a repeatability test on the scale.

2.5.4. ePrint

The ePrint functionality of IND360 allows the current weight values (gross, tare and net) along with a time stamp to be sent to a PC via TCP/IP communication.

2.5.4.1. Configuration

ePrint is simply configured by setting the port for the ePrint feature under the Communication > Service section of the IND360 web interface. Messages can be viewed in any PC software capable of receiving messages via TCP/IP (e.g. HyperIndicator). Connect via the IP address of the IND360 service port and the port number previously set in the web interface.

2.5.4.2. Triggering an ePrint

ePrint can be triggered in two ways:

1. Pressing the ePrint button on the keypad of the IND360
2. Configuring an input to trigger the ePrint function
3. PLC command for ePrint

2.5.4.3. Format of ePrint Message

The ePrint message received will show the date and time the ePrint was executed, the gross weight, net weight, tare weight and a line of asterisks to mark the end of the message.

```
Date time:          01:27:28  01/01/2010
Gross:              6.81 kg
Net:                0.00 kg
Tare:               6.81 kg
*****
```

Figure 2-6: Example of a Normal ePrint Message

```
Date time:          01:28:00  01/01/2010
Gross:              6.81 kg
Net:                5.58 kg
Preset tare:       1.23 kg
*****
```

Figure 2-7: Example of a Preset Tare ePrint Message

3 Configuration

This chapter provides information about how to configure the IND360 automation indicator's operating system. It describes access to the web interface, where functions can be enabled, disabled, or defined by entering parameter values in specific setup screens.

3.1. Accessing the Web Interface

The IND360 web interface is a built-in tool and supports the following functions:

- Configuration of the IND360 automation indicator via web browser such as Chrome or Edge.
- Access diagnostic and maintenance information for service purposes.

3.1.1. IP Settings for Web Interface

To use the web interface on IND360, your PC and the IND360 must be in the same local network, physically connected on the same network, and have correct IP configuration. The IP configuration of the IND360 can be viewed and changed via the front panel keypad and display. Based on the operating system, the method to set the IP configuration of the PC can be different. For a PC running Windows 10, for example:

1. Go to **Control Panel | Network** and **Internet | Network** and **Sharing Center | Change Adapter Settings**.
2. Right-click the Ethernet network.
3. Click Properties.
4. Double click Internet Protocol Version 4 (TCP/IP).
5. Select Use the following IP address.
6. Fill in the network information.

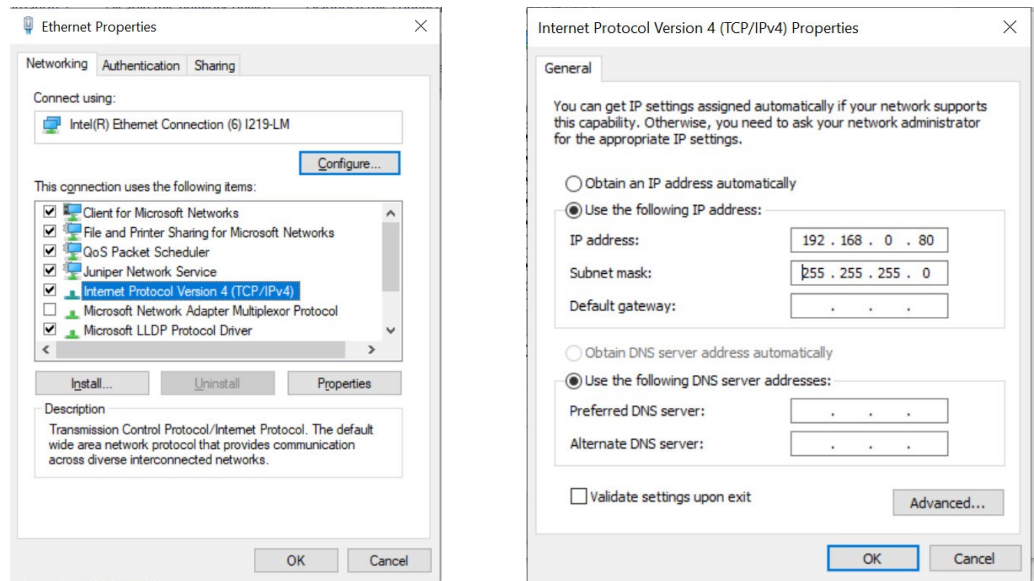

Figure 3-1: Local Area Connection Settings, Windows 10

Typical PC and IND360 IP configuration:

- PC IP address: 192.168.0.X (X = 0 ~ 255, avoid using 8 or 2 when possible, since the default IP address of IND360 is 192.168.0.8 for the service port and 192.168.0.2 for the industrial Ethernet port)
- Subnet Mask: 255.255.255.0
- IND360 IP address: 192.168.0.Y (Y = 0 ~ 255)
- Subnet Mask: 255.255.255.0

When there is more than one IND360 automation indicator on the network, each must have a unique "Y" value. Please note that when using an IND360 unit with industrial Ethernet, the IP address of the service port (web interface) is different from the IP address for the industrial Ethernet connection.

3.1.2. Connecting to the Web Interface

Once the IP settings are correct for the IND360 and the PC and both devices are on the same physical network, the web interface can be accessed using any web browser. For best results, the latest versions of Chrome and Edge are recommended.

Type the IP address of the IND360 in the address bar of the web browser. The Home page of the web interface will display. From here, tabs on the left side of the page can be used to navigate to other pages. The various sections and tabs of the web interface are explained in detail in the rest of this section.

3.2. Overview of Configuration

The setup menu tree can be expanded to show every branch and leaf node in the indicator's configuration. Use the navigation keys to select the desired setup screen.

The setup menu has seven major branches:

- Home
- Device
- Scale
- Application
- Terminal
- Communication
- Maintenance

Details for each branch are provided throughout this chapter.

- The presence of setup menu branches will depend on installed options and, in some cases, configuration selections made in other areas of setup. For example, the Industrial Ethernet branch is only available when the Industrial Ethernet option board has been installed in the IND360.

3.3. Home

The Home screen displays the various weight values for the IND360 and current status of the digital inputs and outputs.

3.3.1. Weight

Displays various weight values for the scale. Press "T" to tare the scale. This will change the IND360 local display to net mode but the Home screen (web interface) will always show the gross weight, net weight and the new tare weight. Please note that the "Preset tare" value must be blank to execute a regular pushbutton tare. Refer to section 3.3.1.4 for additional details.

Press "0" to perform a pushbutton zero. This zero will fail when stability and pushbutton zero criteria set in other pages of the web interface are not met.

Press "C" to clear the current tare value. This will set the Tare value on the Home screen to 0, and the Net and Gross weights will match. The local display will exit net mode and return to show gross weight.

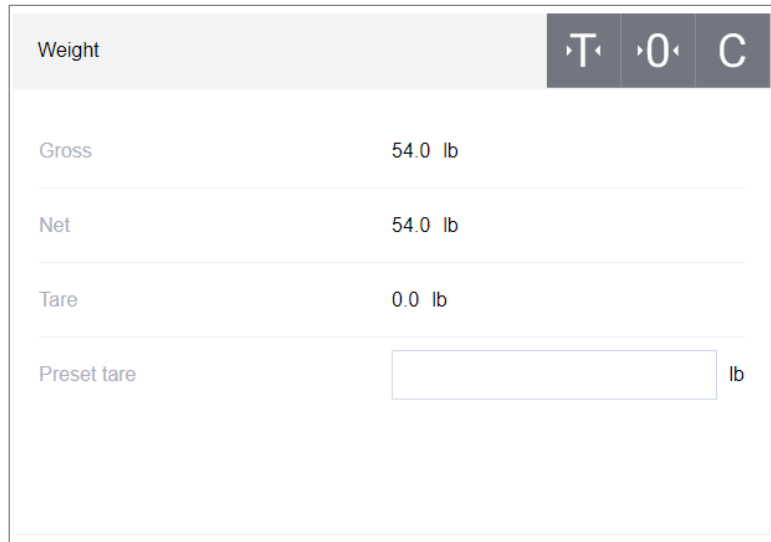

Figure 3-2: Web Interface Weight Display

3.3.1.1. Gross

Displays the current gross weight value for the scale, in primary units.

3.3.1.2. Net

Displays the current net weight value for the scale, in primary units. When no tare is taken, Net and Gross values will be equal.

3.3.1.3. Tare

Displays the current tare weight value for the scale, in primary units. When no tare is taken, Tare will equal zero.

3.3.1.4. Preset Tare

When a known tare weight is to be subtracted from the gross weight, enter the preset tare value here. Press the "T" button to tare using this preset value regardless of the weight currently on the scale.

3.3.2. Discrete Input

The Discrete Inputs show the current state of the digital inputs, if available on the IND360. If the input is at a logic high level, a checkmark in a green circle will appear next to that input. If the input is at a logic low level, an empty circle will appear next to the input. This can be useful for initial testing of input wiring.

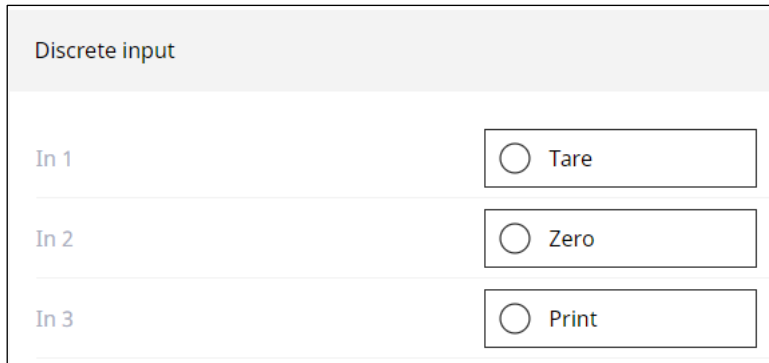

Figure 3-3 Web Interface Discrete Input with all inputs off

3.3.3. Discrete Output

The Discrete Outputs show the current state of the digital outputs if available on the IND360. If the output is at a logic high level, a checkmark in a green circle will appear next to that output. If the output is at a logic low level, an empty circle will appear next to the output.

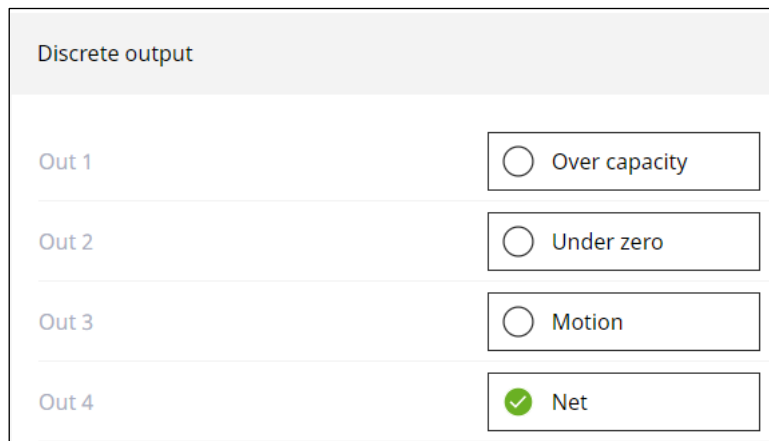

Figure 3-4 Web Interface Discrete Output with Output 4 turned on

3.4. Device

The Device screen provides read-only information about the IND360 device.

3.4.1. Info Recall

Information recall provides information on the model name, serial number and software versions of the IND360. This screen also displays any weight approval modes currently selected, the PLC interface, the digital inputs and outputs available and whether an analog output option is installed. This information can be useful to identify device features.

3.4.2. PLC

The device PLC information displays the PLC options available for the connected IND360. The PLC communication type, MAC address, IP address, and gateway address for the IND360 can be found here. These values are read-only on this page and can only be edited elsewhere in the web interface.

3.4.3. Service Ethernet

The Service Ethernet section displays read-only values for IP address, subnet mask and gateway address for connecting to the IND360 service port (web interface). Please note that this IP address is different from the one used to connect to the PLC via Industrial Ethernet.

3.5. Scale

- When the metrology switch is in the approved position (SW1-1 = ON), changes to protected parameters in the Scale branch are not permitted.

The Scale branch provides the following access to the configuration of the connected scale:

Each type of scale in the IND360 offers different parameters in the Scale branch. To simplify the scale programming process, each scale type is described in a separate section in this chapter. Refer to the correct section for the type of scale used.

- Analog Section 3.5.1
- POWERCELL Section 3.5.2
- Precision Section 3.5.3

A Reset is present at the end of the branch to enable a limited reset to the factory default settings for the Scale branch parameters. Refer to Appendix B, **Default Settings**, for details.

3.5.1. Scale – Analog

3.5.1.1. Type

The Scale Type screen permits a name to be assigned to the scale, displays the scale type, provides a selection list for the Approval mode, and allows entry of the approval class.

The screenshot shows a web interface for configuring a scale. At the top, there is a header area with the word 'Type' on the left and a dark grey button labeled 'SET' on the right. Below the header, there are three main configuration fields, each with a label on the left and a corresponding input area on the right. The first field is 'Name', with a text input box containing 'Tank-1'. The second field is 'Scale type', with a dropdown menu showing 'Analog'. The third field is 'Approval', with a dropdown menu showing 'None' and a small downward arrow icon. The entire interface is enclosed in a light grey border.

Figure 3-5: Web Interface Scale Type Display

3.5.1.1.1. Name

The Name field enables entry of the scale identification. Enter the scale name (an alphanumeric string of up to 12 characters) in the Name entry box.

3.5.1.1.2. Scale Type

The Scale Type field indicates which type of scale this indicator supports.

3.5.1.1.3. Approval

Approval refers to the metrological (weights and measures) approval configuration for the specific scale. The selection list includes:

None [default], USA, OIML, Canada

None is the recommended option when the IND360 is part of an automation system.

When the approval is configured as USA, OIML (countries outside of USA and Canada), or Canada, and the metrology security switch, SW1-1, is set to ON, and access to the Scale setup parameters in the menu tree and web interface will be limited to view only.

When an approval is selected but SW1-1 is not ON, it will not be possible to leave setup, and a message will appear: "Approval on, enable SW-1".

3.5.1.1.4. Class

The Class field selection is shown when an analog scale indicator is selected as approved. This selection must match the Weights and Measures approval class when the indicator is used in an approved mode. The selections are:

III [default]

3.5.1.2. Capacity & Increment

Use the Capacity and Increment setup screen to select primary units, program the capacity and increments sizes, and the blanking over capacity value.

Capacity & Increment		SET
Primary units	lb	▼
Capacity	100.0	lb
Increment	0.1	▼ lb
Blank over capacity	5	d

Figure 3-6: Web Interface Capacity and Increment Screen

3.5.1.2.1. Primary Units

Set the primary units from the selection box choices, which include:

grams (g), **kilograms (kg)** [default], pounds (lb), tonnes (t), tons (ton)

3.5.1.2.2. Capacity

Enter the capacity value for the scale. Values from 1 to 1,000,000 are possible. The display will blank in an over capacity condition at x display divisions above this value where x = the number of divisions used in the Blank Over Capacity parameter below. When the capacity entered (in conjunction with the increment size stored) results in more than 100,000 display divisions, the increment size will automatically be reduced so that the number of display

divisions is below 100,000. Always check the increment size after making a change to the capacity. Scale calibration should also be checked after a change in capacity.

3.5.1.2.3. Increment

Select the desired display increment size by selecting from the available choices in the drop-down menu. The full range of increments is from 0.0001 to 200. The displayed choices are based on the capacity of the scale – refer to the previous parameter. The minimum number of resulting display divisions is 500 and the maximum 100,000.

3.5.1.2.4. Blank Over Capacity

Blanking of the display is used to indicate an over-capacity condition. Set the blank over capacity for the number of display increments that the indicator is permitted to go over capacity. For example, when capacity is set at 500 kg by 0.1 kg increments and the blank over capacity setting is 5 d, the indicator can display weights up to 500.5 kg. At weights over 500.5, dashed lines will display instead of a weight.

3.5.1.3. Calibration (Adjustment)

3.5.1.3.1. Calibration (Adjustment) Settings

The Calibration screens allow the entry of a geo code adjustment value, calibration units, and linearity adjustment.

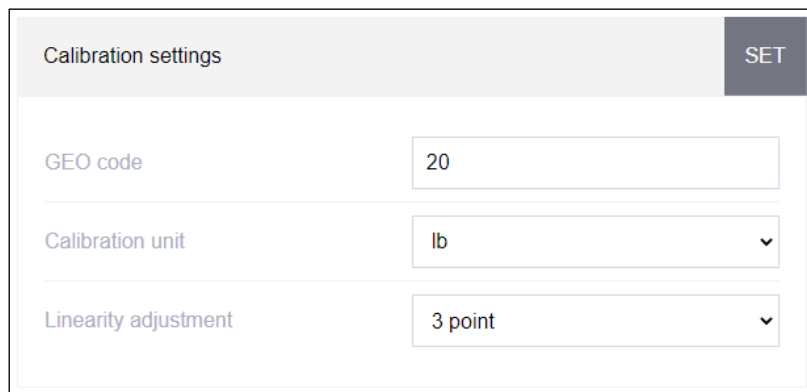

Figure 3-7: Web Interface Calibration Settings Screen

Geo Code

Enter the geo code for the appropriate geo adjustment value for the current geographical location. Geo codes are numbered 0–31. Refer to Appendix D, **Geo Codes** to find the appropriate Geo Code for the installation location.

Calibration Units

Select the unit that calibrations and adjustments will be completed in:

grams (g), **kilograms (kg)** [default], pounds (lb), tonnes (t), tons (ton)

Linearity Adjustment

Select the linearity adjustment from the selection box. Selections are as follows:

- Disabled** [default] Use only zero and one span point
- 3 point Use zero, midpoint, and highpoint
- 4 point Use zero, lowpoint, midpoint, and highpoint

5 point

Use zero, lowpoint, midpoint, mid-highpoint, and highpoint

3.5.1.3.2. Zero Adjust

To perform zero adjustment

1. Empty the scale and press the START button on the web interface page. The status of the capture zero operation displays.
2. When the operation is complete, the Status message will change to say the zero adjustment was completed.
3. When motion is present during the zero capture process, the indicator will process the dynamic weight readings then display a warning message indicating zero adjustment was completed with dynamic values.
4. When the zero adjustment is successful, the status "Completed" or "Completed in dynamic" displays. If the capture zero operation was not successful, an error message that reads "Zero Failure" displays. "Completed in dynamic" indicates that the zero was completed while the weight value was unstable according to the stability settings. There are many things that could cause the weight value to be unstable while performing the zero adjustment (e.g. using stability tolerances that are too tight or improper termination of the sense and excitation conductors for the analog scale). Contact a local METTLER TOLEDO representative for assistance if the desired scale stability cannot be achieved. If the zero fails, repeat the zero capture procedures. If the zero continues to fail, contact a local METTLER TOLEDO representative for assistance.

3.5.1.3.3. Span Adjust

Span (Sensitivity) Adjust initiates an adjustment sequence using successive test weights to capture span that can be performed independently of adjusting zero.

Span adjust		ESC	START
Test load 1	<input type="text" value="50"/>	lb	
Test load 2	<input type="text" value="100"/>	lb	
Status	Place test load on scale and start adjustment		

Figure 3-8: Web Interface Span Adjust Screen

To perform span adjustment:

1. Enter the weight for test load 1 and all other test loads when linearity has been enabled in the Calibration Settings. Each test load value must be larger than the previously entered test load value, because the adjustment workflow assumes that the test weight values are accumulated. For example, when the two-step adjustment is chosen and each test weight is 10kg, the first value must be 10kg and the second must be 20kg.
2. Place test load weight 1 on the scale.
3. Press "START". The status of the weight capture operation displays. When the operation is complete, a status message displays that verifies the completion of the weight capture.
4. If needed, press "ESC" to abort the adjustment process.

5. After the first adjustment step has completed, the menu will either display a prompt for the next calibration weight to be added (when 2, 3, or 4 test load steps are enabled by the linearity adjustment parameter) or will show a successful or failed adjustment status.
6. When motion is present during the span capture process, the indicator will process the dynamic weight readings and Status will change to "Completed in Dynamic". Press "Save" to complete the span adjustment using the dynamic readings. Press "ESC" to abort the adjustment process. There are many things that could cause the weight value to be unstable while performing the span adjustment (e.g. using stability tolerances that are too tight, or improper termination of the sense and excitation conductors for the analog scale). Contact a local METTLER TOLEDO representative for assistance if the desired scale stability cannot be achieved.
7. Repeat steps 2-4 for test loads 2, 3, and 4 (depending how many points are enabled by **Linearity adjustment**). Press the "Continue" button after loading each test weight. Test loads that have already been adjusted are grayed out on the display.
8. When the capture span operation is successful, Status will change to "Completed". If the capture span operation was not successful, Status will change to "Failure". When the adjustment completes, press "Done" to save the adjustment or press "ESC" to abort the process without saving the adjustment values. If the adjustment fails, repeat the Span Adjustment procedures. If the adjustment continues to fail, contact a local METTLER TOLEDO representative for assistance.

3.5.1.3.4. Step Adjust

Step Adjust (substitution method) initiates a procedure that enables a "build-up" adjustment for tanks and hoppers. For step adjust, an identical amount of test weight is added for each step of the calibration procedure.

Step adjust	ESC	START	CONTINUE
Test load 1	<input type="text" value="25"/>		lb
Current weight	25.0		
Target weight	---		
Step count	1		
Status	Completed		

Figure 3-9: Web Interface Step Adjust Screen

To perform a step adjustment:

1. Enter the target weight for the test load (the same amount of test load weight is used in each step).
2. Add test weight to the tank/hopper.
3. Press "Start" to begin the adjustment with the test load. The test load is captured and span factors are saved. The Status then changes to prompt "Completed."
4. Press "Continue".

5. Remove the test weight. The active display returns to zero. Press "Remove_OK"
6. Fill the tank/hopper with a substitute material up to near the target weight. It does not have to be the exact target weight.
7. Press "Add_OK". The target weight value recalculates to show the substitute material weight plus the initial intended target weight. The display changes to the next prompt "Add test weight."
8. Add test weight to the tank/hopper. The active display shows the weight.
9. Press "Start". When the actual weight does not equal the target, a new span factor calculates and the display changes to "Capturing span." The active weight display changes to match the target weight value.
10. Repeat steps 4 through 9 until an appropriate number of adjustment steps have been completed for the specific application.
11. Once all steps are completed press "Done" to save the adjustment values.
12. Press "ESC" at any step in the procedure to stop the step adjustment process.

3.5.1.3.5. CalFree™

CalFree™ is an adjustment method for a scale that does not use test weights. This is based on manual entry of capacity and performance data from the load cell or load cell platform. This method of adjustment can be used for initial check-out and testing of systems or when a large structure is used as the weighing vessel and it is not possible to apply test weights to the structure. METTLER TOLEDO highly recommends that test weights or RapidCal™ be used because they provide the most accurate calibration and will identify weighing errors caused by the structure or foundation.

Scale adjustment using CalFree™ will not be accurate when using Zener Diode barriers (such as METTLER TOLEDO ISB05 and ISB05x) between the indicator and the scale. DO NOT use CalFree™ when barriers are installed.

Calfree		SET
Cell capacity	<input type="text" value="1000.000000"/>	
Unit	<input type="text" value="kg"/>	▼
Rated cell output	<input type="text" value="1.00000"/>	mv/v

Figure 3-10: Web Interface CalFree™ Display

To perform span adjustment using CalFree™:

1. Enter the load cell capacity. The total load cell capacity should be entered here. For example, for a tank with three 5000 kg cells, cell capacity would be 3 x 5000 kg or 15000 kg.
2. Select the Unit for the Cell Capacity entered in the previous step:
grams (g), **kilograms (kg)** [default], pounds (lb), tonnes (t), tons (ton)

3. Enter the rated load cell output value. When multiple load cells are used, the average output of all cells should be entered here. The average output is determined by adding the output values of all cells together and dividing the sum by the number of cells.
4. Press "Set". The span is calculated using the parameters entered.
5. When the adjustment operation is successful, Status will change to "Completed". If the adjustment operation was not successful, Status will change to "Failure". If the adjustment fails, repeat the CalFree™ procedure. If the adjustment continues to fail, contact a local METTLER TOLEDO representative for assistance.

3.5.1.4. Zero & Tare

This section provides access to Auto Zero Maintenance (AZM) settings, under zero blanking, power-up zero, and pushbutton zero parameters.

3.5.1.4.1. Auto Zero & Display

Auto Zero is a means of adjusting zero when the scale is empty. Auto Zero compensates for conditions like dust, rain or snow buildup on a scale platform.

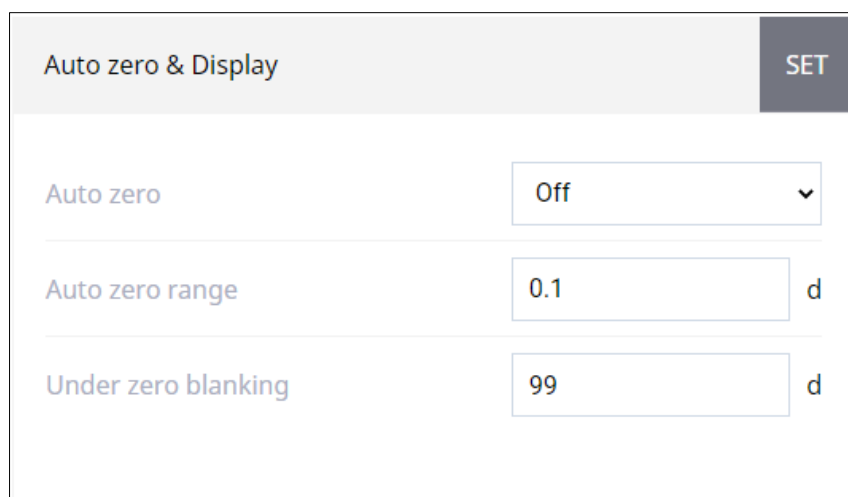

Figure 3-11: Web Interface AZM & Display Screen

Auto Zero

Use the Auto Zero parameter to select the auto zero maintenance parameter. The choices include:

Off [default], Gross, Gross and Net

Auto Zero Range

Set the auto zero range for the number of divisions (d) around the current zero setting in which auto zero will operate.

Under Zero Blanking

Blanking of the display is used to indicate an under-zero condition when the weight on the scale falls below the current zero reference. Set the under zero blanking for the number of divisions (d) that the indicator is permitted to go under zero before blanking.

- A value of 99 disables blanking under zero and the indicator will display a weight up to 50% of the capacity in the negative direction. For example, when the capacity is 100kg, blanking will occur at any value below -50kg. This is recommended when the IND360 is used in an automation system.

3.5.1.4.2. Ranges

Use the settings on the Ranges screen to enable or disable Power Up Zero capture and Pushbutton Zero and to set the ranges around the original zero condition for the scale for applying these functions.

Ranges		SET
Power up zero	Use calibrated zero	▼
Pushbutton zero	Enabled	▼
Pushbutton zero +range	2	%
Pushbutton zero -range	2	%

Figure 3-12: Web Interface Ranges Screen

Power Up Zero

When "Capture New Zero" is selected, the indicator tries to capture zero upon power up and a range within which zero will be captured is shown and is programmable. When "Use Last Zero" or "Use Calibrated Zero" is selected, the initial zero reference at power up will revert to the most recent zero reference point or to calibrated zero based on the Power Up selection on the Auto Zero & Display parameters. The selections are:

Use Last Zero, **Use Calibrated Zero** [default], Capture New Zero

Power Up Zero Range

When Power Up Zero is set to "Capture New Zero", –Range and +Range fields will display for setting the range around the original adjusted zero of the scale within which Power Up Zero can be applied. The range units are percent.

For example, when the +Range setting for Power Up Zero is set at 2%, Power Up Zero will only occur when the weight reading on the scale is less than 2% of scale capacity above the original calibrated zero reference. When the –Range setting for pushbutton zero is set at 2%, Power Up Zero will only occur when the weight reading on the scale is less than 2% of scale capacity below the original calibrated zero reference.

- When Power Up Zero capture is enabled and the weight on the scale is outside of the zero capture range, the display will indicate either EEE or -EEE until the weight is adjusted to be within this range and zero is captured.

Pushbutton Zero

When Pushbutton Zero is enabled, the keypad ZERO pushbutton will operate to capture new zero reference points. The choices for pushbutton zero are:

Disabled, **Enabled** [default]

- When Pushbutton Zero is Disabled, execution of a remote zero is still possible via the web interface, a discrete input or from PLC commands. To set the zero range for these remote zero functions, first enable the Pushbutton Zero, select the pushbutton zero range and then disable the Pushbutton Zero.

Pushbutton Zero Range

When Pushbutton Zero is enabled, Positive Range and Negative Range fields will display for setting the range around the original calibrated zero of the scale within which Pushbutton Zero can be applied. The range units are percent.

For example, when the Positive Range setting for Pushbutton Zero is set at 2%, Pushbutton Zero can only be used when the weight reading on the scale is less than 2% above the original calibrated zero reference. When the Negative Range setting for Pushbutton Zero is set at 2%, the Pushbutton Zero can only be used when the weight reading on the scale is less than 2% below the original calibrated zero reference.

3.5.1.4.3. Tare

Tare is used to subtract the weight of an empty container from the gross weight on the scale to determine the net weight of the contents.

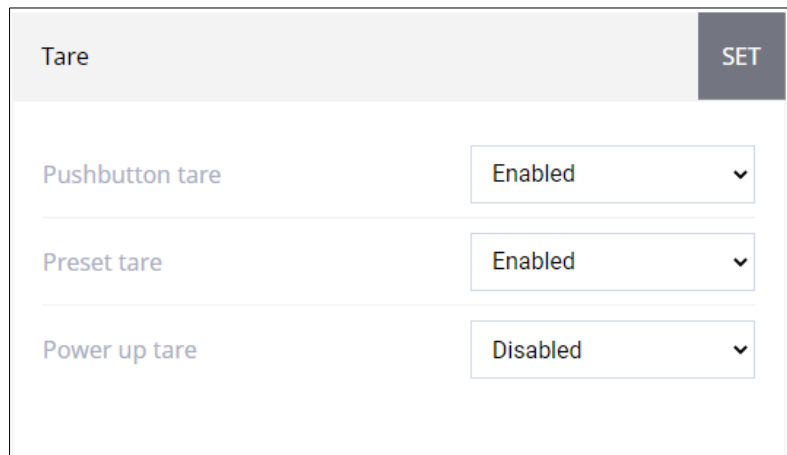



Figure 3-13: Web Interface Tare Screen

Pushbutton Tare

When pushbutton tare is enabled, the front panel tare key  can be pressed when an empty container is on the scale to determine tare. The indicator displays a zero weight and net mode. When the container is loaded and placed back on the scale, the indicator displays the net weight of the contents. The selections include:

Disabled, **Enabled** [default]

- When Pushbutton Tare is Disabled, execution of a remote Tare is still possible via the web interface, a discrete input, or using PLC/DCS commands.

Preset Tare

When preset tare is enabled, the known value for the empty weight of a container (tare) can be entered manually. The indicator will then display the net weight of the contents of the container. Preset tares are automatically rounded to the closest display division. Preset tares are executed via the Home page of the web interface or via PLC/DCS command. Choices are:

Disabled, **Enabled** [default]

3.5.1.5. Filter & Stability

Vibration introduces instability into your system. It is always recommended to attempt to mechanically isolate your scale from its surroundings using isolation pads or springs. On scale mixers, agitators and vibrators will introduce additional vibration. The Filter section offers three settings to filter vibration electronically: Static Weighing Mode, Limit Frequency and Environment. Note that these settings can also be set by the PLC or DCS via the Automation Interface.

3.5.1.5.1. Filter

Weighing Mode

Selecting "Normal" should only be used for non-automatic, human-powered weighing. This gives the most stable response, required for "business-to-consumer" weighing. Not recommended with a process controlled by an automation device. Set the weighing mode to "Dynamic" when the process is controlled by a device such as a PLC or DCS.

Environment

Sets the level of attenuation applied to the signal above the limit frequency. A very stable environment will have the least attenuation applied to the signal and a very unstable environment will have the strongest attenuation. It is recommended to adjust this value first when changing filter settings. Start with "very stable" and work your way down. Possible selections are:

Very Stable, Stable, **Standard** [default], Unstable, Very Unstable

Limit Frequency

Marks the point at which the filtering process begins to affect the disturbance. Disturbances above the limit frequency will have filtering applied. Recommendation is to start at 20 Hz and reduce the frequency only after adjusting the environment setting. The lower the frequency, the better the disturbance rejection, but it will increase latency.

3.5.1.5.2. Stability

The IND360 automation indicator includes a stability detector (weight change over time). This setting is used to block zero and tare functions from occurring during periods of weighing instability and an indicator on the display will show the status of scale motion. This setting will also affect the status of the motion bit in the automation status word in the SAI message scale status word 1. The function of stability is influenced by the filter settings above. The Stability setup screen enables setting a motion range, no-motion interval and timeout period.

Stability		SET
Motion range(0.1-9.9d)	<input type="text" value="0.5"/>	d
No-motion interval(0.0-1.0s)	<input type="text" value="0.3"/>	s
Timeout(0-99s)	<input type="text" value="3"/>	s

Figure 3-14: Web Interface Stability Screen

Motion Range

Sets the motion range (in divisions) that the weight is permitted to fluctuate and still indicate a no-motion condition. Values from 0 d to 9.9 d are possible with the default value being 1.0 d.

No-motion Interval

The no motion interval defines the amount of time (seconds) that the scale weight must be within the motion range to indicate a no-motion condition. Values from 0.0 (motion detection disabled) to 1.0 are possible, the default value being **0.3** seconds. A shorter interval means that a no-motion condition is more likely, but may make weight measurement less precise.

Timeout

Defines the period (in seconds) after which the indicator stops attempting to perform a function that requires a no-motion condition (such as a zero or tare command) and aborts the function. This timeout is used regardless of the source of the command such as the keypad, discrete input, PLC/DCS or web interface. Values from 0 to 99 seconds are possible with the default value being 3 seconds. A smaller value means that less time will be used to check for no-motion before aborting a command. When a value of 0 is entered, there must be no-motion when a command is given or it will fail immediately.

3.5.1.6. **Reset**

Refer to section 3.5.1.6.

3.5.2. POWERCELL®

3.5.2.1. Type

The Scale Type screen permits a name to be assigned to the scale, allows entry of the number of active and dummy load cells, and provides a selection list for the Approval mode.

Type		SET
Name	<input type="text"/>	
Scale type	POWERCELL	
Active LCs(1-8)	<input type="text" value="1"/>	
Dummy LCs	<input type="text" value="0"/>	
Approval	<input type="text" value="None"/>	▼
Platform model	<input type="text"/>	
Platform S/N	<input type="text"/>	

Figure 3-15: Web Interface Type Screen

3.5.2.1.1. Name

The Name field enables entry of the scale identification. Enter the scale name (an alphanumeric string of up to 12 characters) in the Name entry box.

3.5.2.1.2. Scale Type

The Scale Type field indicates which type of scale this indicator supports.

3.5.2.1.3. Approval

Approval refers to the metrological (weights and measures) approval configuration for the specific scale. The selection list includes:

None [default], USA, OIML, Canada

When the approval is configured as USA, OIML (Rest of World) or Canada, and the metrology security switch, SW1-1, is set to ON, access to the Scale setup parameters in the menu tree and the web interface will be limited to view only.

When an approval is selected but SW1-1 is not ON, it will not be possible to leave setup, and a message will appear: "Approval on, enable SW-1".

3.5.2.1.4. # of Active Load Cells

Enter the number of POWERCELL® load cells in the scale network. Values from 1 to 8 are valid. Active load cells are points that are actively measuring weight.

- 3.5.2.1.5. # of Dummy LCs
Enter the number of dummy load cells for the scale. A dummy load cell is a point that supports some portion of the weight to be measured but does not actually measure the weight.
- 3.5.2.1.6. Class
The Class field selection is shown when a scale indicator is selected as approved. This selection must match the Weights and Measures approval class when the indicator is used in an approved mode. The selections are:

III [default]
- 3.5.2.1.7. Platform Model
If a digital platform scale such as a PowerDeck™ scale is paired with IND360, the model of the connected scale will display here.
- 3.5.2.1.8. Platform S/N
If a digital platform scale such as a PowerDeck scale is paired with IND360, the serial number of the connected scale will display here.
- 3.5.2.2. Load Cell Address
This branch is used to address the POWERCELL® load cells. There are two different methods provided to address the load cells. Refer to Table 3-1 as a guide as to which one to use.

Table 3-1: Addressing Method

Cell Address Method	Description
Single Cell Addressing	This procedure would typically be used during the replacement of a cell, off-site testing or pre-installation when there is only one cell connected in the network. It could also be used to discover a single connected cell's serial number and node address. During an actual on-site installation when many load cells are already connected in the network, or when installing a new scale, the Manual procedure should be used.
Manual Address	Typically, this procedure is used when installing a new scale with load cells that have the factory default node address. The serial number and location of each cell must be known.

- 3.5.2.2.1. Single Cell Address
Use the Single Cell Address step to set the node address of a load cell identified by its serial number. This procedure would typically be used during the replacement of a cell. It can be used with just one cell connected or with an entire network connected.

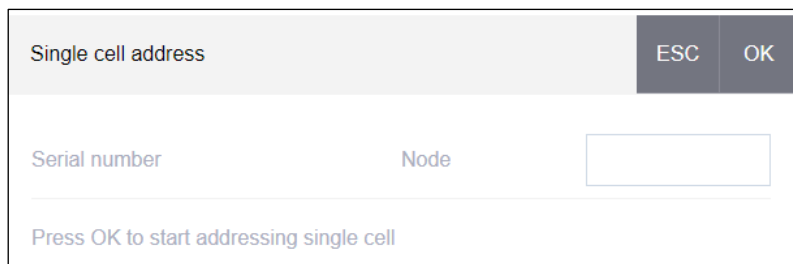

Figure 3-16: Web Interface Single Cell Address Screen

Follow this procedure to perform a single cell address:

1. Make sure the cell that needs to be addressed is connected and click the OK button to begin the process. The display indicates that load cell discovery process has begun, and a message appears briefly:
Loading
2. After the first load cell is detected, that cell's serial number and current node address are displayed. If no cell is found the page will indicate Search Failed.
3. When more than one load cell is connected in the network when this discovery process is executed, the indicator will display the serial number and node address of the first cell it discovers. Before reassigning the node address of the cell that was found, make sure that the serial number matches that of the cell to be addressed. If it is not the desired cell, make sure the desired cell is the only one on the network and start the process again.
4. To quit the addressing process, press the ESC button. Otherwise, enter the required address in the Node entry box and press the Set button to start the addressing process.
5. The display indicates that addressing is in progress by briefly displaying a message of Loading.
6. After the load cell has been successfully assigned a new address, a message of Addressing Completed will be shown.
7. Repeat these steps to address another cell if necessary.

3.5.2.2.2. Manual Address

Use the Manual Address step to program the node address of every load cell connected in a network. Typically, this procedure is used when installing a new scale with load cells that have the factory default node address. To address the cells manually, follow this procedure:

1. Before starting the addressing process, record the serial number of each cell and where each cell is arranged on the scale. Determine which node address should be assigned to each of the cells.
2. Make sure all the cells are connected to the network and press the Search button to begin the process.
3. The display will indicate that the process has started by displaying a message of Loading
4. The discovery process will continue even after the programmed number of cells have been discovered to make sure "extra" cells are not connected. This may take several minutes.
5. During the procedure, the indicator will automatically assign a unique node address to each of the cells discovered. The addresses are assigned arbitrarily by the indicator. After the process is complete, the serial number and node address for each cell is displayed
6. Review the list of serial numbers and location created in Step 1. If the node address preset by the indicator is not appropriate for a particular serial number, manually enter the node number next to the serial number
7. Press the ESC button to abort the process when no changes are required. To change the node address, enter the required address in the Node entry box for every address to be changed, press the SET button to start the addressing process.
8. The web interface indicates that addressing is in progress by showing the message Loading.
9. After the address has been successfully changed, a message of Addressing Completed is displayed.
- When the node address entered by the user is an existing address already assigned to

another load cell, the indicator will complete the addressing as requested, and will reassign the original address of the selected cell to the other load cell. This resolves any potential conflicts by swapping the addresses between the cells.

3.5.2.3. Load Cell Shift Adjust

Small mismatches in mechanical and electronic gain of the load sensing paths can cause the same test weight to produce slightly different readings, depending on the location of the test weight on the scale. The IND360 provides two types of adjustment – adjustment by individual cells or adjustment by pairs of cells.

- The Shift Adjust by Cell or Pair parameter is preset to Cell and cannot be changed when a single load cell is used.

3.5.2.3.1. Shift Adjust

Adjust by Cell

Adjustment by Cell adds a factor to each load cell output to compensate for the slight differences between them. The scale will then output the same weight value regardless of the physical location of the weight on the scale.

Adjust by Pair

Adjustment by Pair ensures a constant reading from the scale regardless of where the load is placed on the long axis between pairs of cells – for instance, in vehicle weighing applications.

Before beginning the shift adjustment procedure, select whether the adjustment will be done by cell or by pair. The procedure for shift adjusting by pair of cells is listed below. The procedure for shift adjusting by individual cell follows the same sequence, but cells are read and adjusted one at a time.

The procedure for shift adjusting by pair of cells is:

1. In the Adjust By selection list, select Pair.
2. Press the "OK" button.
3. The web interface shows an Empty the Scale prompt. Empty the scale then press the "OK" button.
4. The display will indicate that the initial reading is taking place by showing the message Please Wait.
5. After the initial zero reading is complete, the screen will then display the current weight from the cells in the first pair to be adjusted. Follow the on-screen prompting of Place test Weight on Cell 1 & 2 (or the addresses of the current cell pair being adjusted).
6. Place the test load on the platform, centered between cell 1 and cell 2 (or the addresses of the current cell pair being adjusted) then press the "OK" button.
7. The current weight will change to reflect the new readings from the load cells, and then the prompt will show Place test Weight on Cell 3 & 4 (or the addresses of the next cell pair).
8. Move the test load from the previous pair of cells to the next pair keeping the load centered on the platform. Press the "OK" button to continue.
9. The current weight will change to reflect the new readings.
10. Repeat steps 6 through 9 until all cell pairs have been adjusted. An on-screen message of Adjust OK will then be displayed.

11. Press the "ESC" button at any time to end the adjustment process.

3.5.2.3.2. Shift Adjust Single

This procedure allows you to quickly adjust the shift values for a single pair or single cell after a cell has been replaced on the scale. A complete shift adjust (previous section) is more accurate and should be used when more than one POWERCELL® cell has been replaced on the scale.

The indicator allows adjustment by either Cell or Pair. The following example describes the procedure when adjusting by cell. The adjustment by pair follows the same procedure except the indicator will prompt for weight to be placed above a pair of cells instead of a single cell.

To adjust a specific cell (example of Node 3)

1. Select "Cell" for the Shift Adjust Mode
2. Select node 3 (or whichever node is to be adjusted)
3. Press the "OK" button to begin the adjustment.
4. The on-screen prompt shows Empty the Scale. Empty the scale and then press the "OK" button to continue.
5. The display will indicate that the initial reading is taking place by showing the message Please Wait.
6. After the initial zero reading is complete, the screen will then display the current weight from the cell to be adjusted. Follow the on-screen prompting of Place test Weight on LC 3 (or the addresses of the current cell being adjusted). Press the "OK" button.
 - When the last addressed cell or pair on the scale is selected for Shift Adjust, the previous cell or pair is read first prior to the selected cell or pair.
7. An on-screen message will indicate that the indicator is getting shift adjust counts. The cell current weight will change to reflect the new reading from the load cell, and then the prompt will show Place test Weight on LC 4 (or the address of the next cell).
8. Move the test load from the current cell to the next prompted cell then press the "OK" button to continue.
9. The display will indicate that the cell is being read by showing the message Please Wait.
10. After the process is complete, the display will show Adjust OK.
11. Press the "ESC" button at any time to end the adjustment process.

3.5.2.4. Capacity & Increment

Use the Capacity and Increment setup screen to select primary units, program the capacity and increments sizes, and the blanking over capacity value.

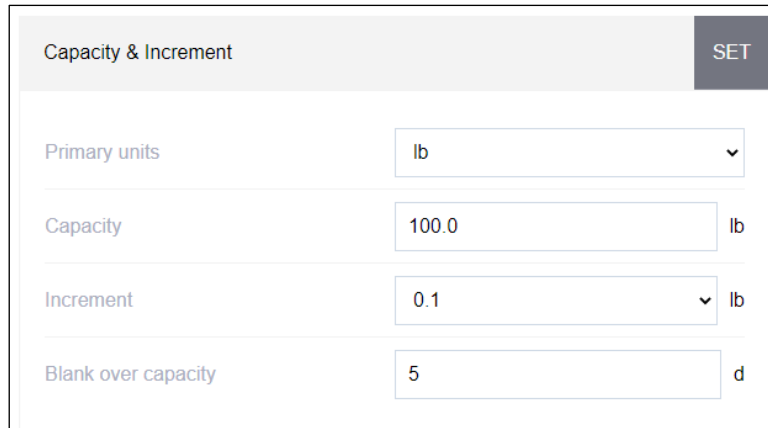

Figure 3-17: Web Interface Capacity & Increment Screen

3.5.2.4.1. Primary Units

Set the primary units from the selection box choices, which include:

grams (g), **kilograms (kg)** [default], pounds (lb), tonnes (t), tons (ton)

3.5.2.4.2. Capacity

Enter the capacity value for the scale. Values from 1 to 1,000,000 are possible. The display will blank in an over capacity condition at X display divisions above this value where X = the number of divisions used in the Blank Over Capacity parameter below. When the capacity entered (in conjunction with the increment size stored) results in more than 100,000 display divisions, the increment size will automatically be reduced so that the number of display divisions is below 100,000. Always check the increment size after making a change to the capacity. Scale calibration should also be checked after a change of the capacity

3.5.2.4.3. Increment

Select the desired display increment size by selecting from the available choices in the drop-down menu. The full range of increments is from 0.0001 to 200. The displayed choices are based on the capacity of the scale (previous parameter). The minimum number of resulting display divisions is 500 and the maximum number is 100,000.

3.5.2.4.4. Blank Over Capacity

Blanking of the display is used to indicate an over-capacity condition. Set the blank over capacity for the number of display increments that the indicator is permitted to go over capacity. For example, when capacity is set at 500 kg by 0.1 kg increments and the blank over capacity setting is 5 d, the indicator can display weights up to 500.5 kg. At weights over 500.5, dashed lines will display instead of a weight.

3.5.2.5. Calibration

3.5.2.5.1. Calibration Settings

The Calibration screens enable entry of a geo code adjustment value, calibration units, and linearity adjustment.

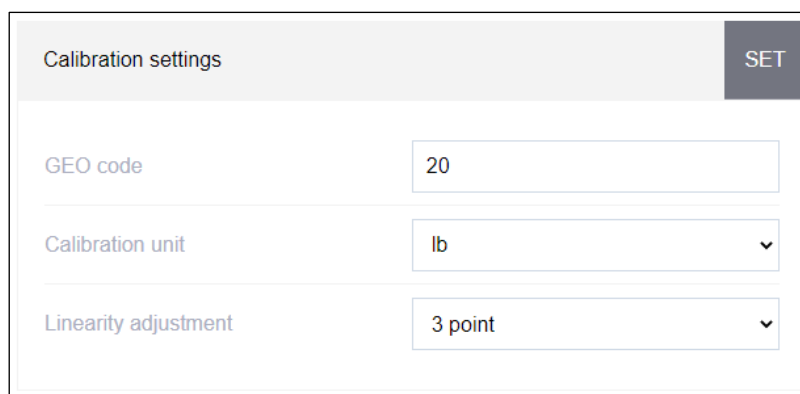

Figure 3-18: Web Interface Calibration Settings Screen

Geo Code

Enter the geo code for the appropriate geo adjustment value for the current geographical location. Geo codes are numbered 0–31. Refer to Appendix D, **Geo Codes** to find the appropriate Geo Code for the installation location.

Calibration Unit

Select the weight unit to be used to calibrate the scale. Calibration units are the same as the primary units selections, which include:

grams (g), **kilograms (kg)** [default], pounds (lb), tonnes (t), tons (ton)

Linearity Adjustment

Select the linearity adjustment from the selection box. Selections are as follows:

Disabled [default]	Use only zero and one span point
3 point	Use zero, midpoint, and highpoint
4 point	Use zero, lowpoint, midpoint, and highpoint
5 point	Use zero, lowpoint, midpoint, mid-highpoint, and highpoint

3.5.2.5.2. Zero Adjust

To perform zero adjustment

1. Empty the scale and press the START button on the web interface page. The status of the capture zero operation displays.
2. When the operation is complete, the Status message will change to say the zero adjustment was completed.
3. When motion is present during the zero capture process, the indicator will process the dynamic weight readings then display a warning message indicating zero adjustment was completed with dynamic values. This message provides choices of No and Yes to either reject or accept the dynamic weight calibration.
4. When the zero adjustment was successful, the status "Completed" or "Completed in dynamic" displays. There are many things that could cause the weight value to be unstable while performing the zero adjustment (e.g. using stability tolerances that are too tight). Contact a local METTLER TOLEDO representative for assistance if the desired scale stability cannot be achieved. If the capture zero operation was not successful, an error message that

reads "Zero Failure" displays. If the zero fails, repeat the zero capture procedures. If the zero continues to fail, contact a local METTLER TOLEDO representative for assistance.

3.5.2.5.3. Span Adjust

Span Adjust initiates a sequence to capture span that can be performed independently of capturing zero.

Span adjust		ESC	START
Test load 1	<input type="text" value="50"/>	lb	
Test load 2	<input type="text" value="100"/>	lb	
Status	Place test load on scale and start adjustment		

Figure 3-19: Web Interface Span Adjust Screen

To perform span adjustment:

1. Enter the weight for test load 1 and all other test loads when linearity has been enabled in the Calibration Settings. Each test load value must be larger than the previously entered test load value.
2. Place test load weight 1 on the scale.
3. Press "START". The status of the weight capture operation displays. When the operation is complete, a status message displays that verifies the completion of the weight capture.
4. When needed, press "ESC" to abort the adjustment process.
5. After the first adjustment step has completed, the menu will either display a prompt for the next calibration weight to be added (when 2, 3, or 4 test load steps are enabled by the linearity adjustment parameter) or will show a successful or failed adjustment status.
6. When motion is present during the span capture process, the indicator will process the dynamic weight readings then Status will change to "Completed in Dynamic". Press "Save" to complete the span adjustment using the dynamic readings. Press "ESC" to abort the adjustment process. There are many things that could cause the weight value to be unstable while performing the zero adjustment (e.g. using stability tolerances that are too tight). Contact a local METTLER TOLEDO representative for assistance if the desired scale stability cannot be achieved.
7. Repeat steps 2-4 for test loads 2, 3, and 4 when enabled by linearity adjustment. Press the "Continue" button between loading test weights. Test loads that have already been adjusted are grayed out on the display.
8. When the capture span operation is successful, Status will change to "Completed". If the capture span operation was not successful, Status will change to "Failure". If the adjustment completes, press "Done" to complete the adjustment or press "ESC" to abort the process without saving the adjustment values. If the adjustment fails, repeat the Span Adjustment procedures. If the adjustment continues to fail, contact a local METTLER TOLEDO representative for assistance.

3.5.2.5.4. Step Adjust

Step Adjust initiates a procedure that enables a “build-up” adjustment for tanks and hoppers. For step adjust, the same amount of test weight is added for each step of the calibration procedure.

Step adjust	ESC	START	CONTINUE
Test load 1	<input type="text" value="25"/>		lb
Current weight	25.0		
Target weight	---		
Step count	1		
Status	Completed		

Figure 3-20: Web Interface Step Adjust Screen

To perform a step adjustment:

1. Enter the target weight for the test load (the same amount of test load weight is used in each step).
2. Add test weight to the tank/hopper.
3. Press "Start" to begin the adjustment with the test load. The test load is captured and span factors are saved. The Status then changes to prompt "Remove test weight then fill to target."
4. Remove the test weight. The active display returns to zero.
5. Fill the tank/hopper with a substitute material up to near the target weight. It does not have to be the exact target weight.
6. Press "Start". The target weight value recalculates to show the substitute material weight plus the initial intended target weight. The display changes to the next prompt "Add test weight."
7. Add test weight to the tank/hopper. The active display shows the weight.
8. Press "Start". When the actual weight does not equal the target, a new span factor calculates and the display changes to "Capturing span." The active weight display changes to match the target weight value. The Status changes to the next prompt "Remove test weight then fill to target."
9. Remove the test weight. The active display returns to the previous weight that displayed for the last test load.
10. Repeat steps 5 through 9 until an appropriate number of adjustment steps have been completed for the specific application.
11. Press "ESC" at any step in the procedure to stop the step adjustment process.

3.5.2.5.5. CalFree™ Plus

CalFree™ Plus is an adjustment method for a scale that does not use test weights. This is based on a reading of capacity and performance data stored on the load cell from the factory. This method of calibration can be used for initial check-out and testing of systems or when a large structure is used as the weighing vessel, and it is not possible to apply test weights to the structure. METTLER TOLEDO highly recommends that test weights or RapidCal™ be used whenever possible as this provides the most accurate method of calibration.

To perform calibration of span using CalFree™ Plus

1. Press the Start button
2. Status will change to "CalFree Plus starting" and a message will display saying "Loading"
3. When the calibration operation is successful, a verification message that reads "CalFree Plus Complete" displays. If the calibration operation was not successful, an error message that reads "CalFree Plus Failure" displays. If the calibration fails, repeat the CalFree™ Plus procedure. If the calibration continues to fail, contact a local METTLER TOLEDO representative for assistance.

3.5.2.6. Zero & Tare

This section provides access to Auto Zero settings, under zero blanking, power-up zero, and pushbutton zero parameters.

3.5.2.6.1. Auto Zero & Display

Auto Zero is a means of adjusting zero when the scale is empty. Auto Zero compensates for conditions like dust, rain or snow buildup on a scale platform.

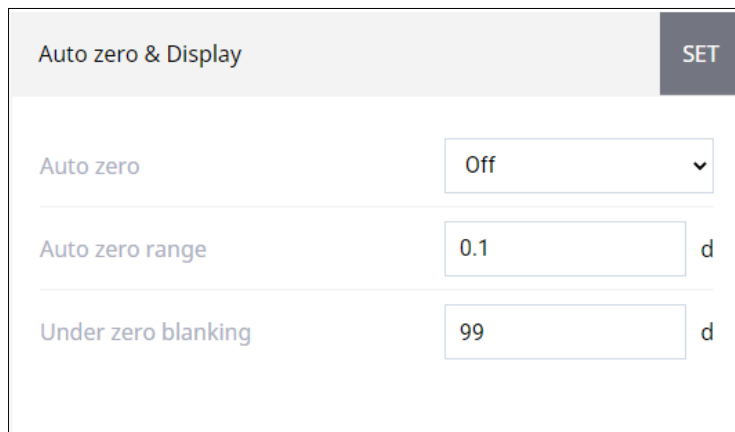

Figure 3-21: Web Interface AZM & Display Screen

Auto Zero

Use the Auto Zero parameter to select the auto zero maintenance parameter. The choices include:

Off, **Gross** [default], Gross and Net

Auto Zero Range

Set the auto zero range for the number of divisions (d) around the current zero setting in which auto zero will operate.

Under Zero Blanking

Blanking of the display is used to indicate an under-zero condition when the weight on the scale falls below the current zero reference. Set the under zero blanking for the number of divisions (e) that the indicator is permitted to go under zero before blanking.

- A value of 99 disables blanking under zero and the indicator will display a weight up to 50% of the capacity in the negative direction. For example, when the capacity is 100kg, blanking will occur at any value below -50kg. This is recommended when the IND360 is used in an automation system.

3.5.2.6.2. Ranges

Use the settings on the Ranges screen to enable or disable Power Up Zero capture and Pushbutton Zero and to set the ranges around the original zero condition for the scale for applying these functions.

Ranges		SET
Power up zero	Use calibrated zero	▼
Pushbutton zero	Enabled	▼
Pushbutton zero +range	2	%
Pushbutton zero -range	2	%

Figure 3-22: Web Interface Ranges Screen

Power Up Zero

When "Capture New Zero" is selected, the indicator tries to capture zero upon power up and a range within which zero will be captured is shown and is programmable. When "Use Last Zero" or "Use Calibrated Zero" is selected, the initial zero reference at power up will revert to the most recent zero reference point or to calibrated zero based on the Power Up selection on the AZM & Display parameters. The selections are:

Use Last Zero, **Use Calibrated Zero** [default], Capture New Zero

Power Up Zero Range

When Power Up Zero is enabled, -Range and +Range fields will display for setting the range around the original adjusted zero of the scale within which Power Up Zero can be applied. The range units are percent.

For example, when the +Range setting for Power Up Zero is set at 2%, Power Up Zero will only occur when the weight reading on the scale is less than 2% of scale capacity above the original calibrated zero reference. When the -Range setting for pushbutton zero is set at 2%, Power Up Zero will only occur when the weight reading on the scale is less than 2% of scale capacity below the original calibrated zero reference.

- When Power Up Zero capture is enabled and the weight on the scale is outside of the zero capture range, the display will indicate either EEE or -EEE until the weight is adjusted to be within this range and zero is captured.

Pushbutton Zero

When Pushbutton Zero is enabled, the keypad ZERO pushbutton will operate to capture new zero reference points. The choices for pushbutton zero are:

Disabled, **Enabled** [default]

- When Pushbutton Zero is Disabled, execution of a remote zero is still possible via the web interface, a discrete input or from PLC commands. To set the zero range for these remote zero functions, first enable the Pushbutton Zero, select the pushbutton zero range and then disable the Pushbutton Zero.

Pushbutton Zero Range

When Pushbutton Zero is enabled, Positive Range and Negative Range fields will display for setting the range around the original calibrated zero of the scale within which Pushbutton Zero can be applied. The range units are percent.

For example, when the Positive Range setting for Pushbutton Zero is set at 2%, Pushbutton Zero can only be used when the weight reading on the scale is less than 2% above the original calibrated zero reference. When the Negative Range setting for Pushbutton Zero is set at 2%, the Pushbutton Zero can only be used when the weight reading on the scale is less than 2% below the original calibrated zero reference.

3.5.2.6.3. Tare

Tare is used to subtract the weight of an empty container from the gross weight on the scale to determine the net weight of the contents.

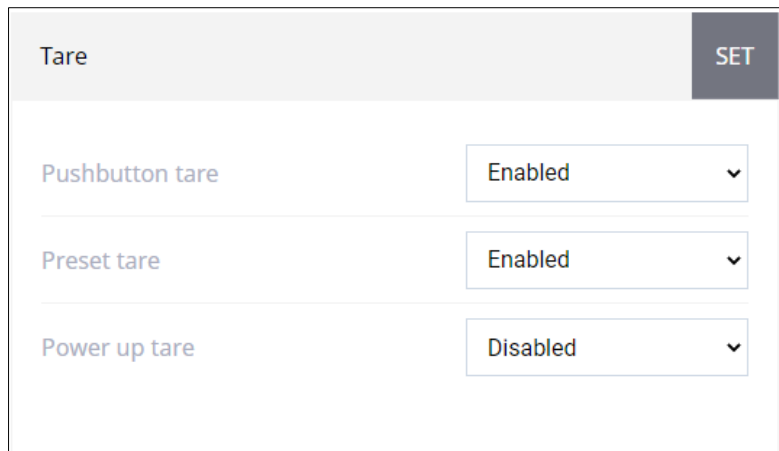



Figure 3-23: Web Interface Tare Screen

Pushbutton Tare

When pushbutton tare is enabled, the front panel tare key  can be pressed when an empty container is on the scale to determine tare. The indicator displays a zero weight and net mode. When the container is loaded and placed back on the scale, the indicator displays the net weight of the contents. The selections include:

Disabled, **Enabled** [default]

- When Pushbutton Tare is Disabled, execution of a remote Tare is still possible via the web interface, a discrete input, or using PLC commands.

Preset Tare

When preset tare is enabled, the known value for the empty weight of a container (tare) can be entered manually. The indicator will then display the net weight of the contents of the container. Preset tares are automatically rounded to the closest display division. Preset tares can be executed via the Home page of the web interface or via PLC command.

Choices are:

Disabled, **Enabled** [default]

3.5.2.7. Filter & Stability

In many weighing applications, vibration can introduce error into your system or cause delays in the transfer of weight to your automation device. It is always recommended to first attempt to mechanically isolate your scale from the surroundings.

METTLER TOLEDO POWERCELL® brand load cells contain active weighing electronics that actively adjust the weight to achieve maximum performance including filtering local to the load cell. Should this be inadequate for your automated weighing application, the IND360's low pass filter provides a choice of additional filter settings.

3.5.2.7.1. Filter

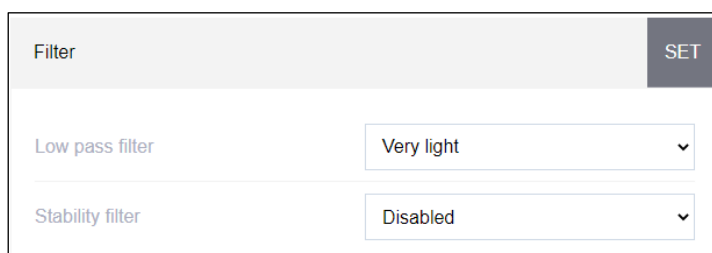

Figure 3-24: Web Interface Filter Screen

Low Pass Filter

The low pass filter is used to filter high frequency disturbances from affecting the weighing signal. Recommended to start with "Very Light" and apply progressively more heavy filtering until acceptable filtering is achieved.

Possible selections are:

Very Light [default], Light, Medium, Heavy

Stability Filter

The Stability Filter should only be enabled for non-automatic, human-powered weighing. The filter gives the stable response required by "legal for trade" weighing. For processes controlled by an automation device, it is recommended that the filter be disabled. Possible selections are:

Disabled [default], Enabled

3.5.2.7.2. Stability

The IND360 automation indicator includes a stability detector (weight change over time). This setting is used to block zero and tare functions from occurring during periods of weighing instability and an indicator on the display will show the status scale motion. This setting will also affect the status of the motion bit in the automation status word in the SAI message scale status word 1. The function of stability is influenced by the filter settings above.

The Stability setup screen enables setting a motion range, no-motion interval and timeout period.

Stability		SET
Motion range(0.1-9.9d)	<input type="text" value="0.5"/>	d
No-motion interval(0.0-1.0s)	<input type="text" value="0.3"/>	s
Timeout(0-99s)	<input type="text" value="3"/>	s

Figure 3-25: Web Interface Stability Screen

Motion Range

Sets the motion range to the weight value (in divisions) that the weight is permitted to fluctuate and still indicate a no-motion condition. Values from 0 d to 9.9 d are possible with the default value being 1.0 d.

No-motion Interval

The no motion interval defines the amount of time (seconds) that the scale weight must be within the motion range to indicate a no-motion condition. Values from 0.0 (motion detection disabled) to 1.0 are possible, the default value being **0.3** seconds. A shorter interval means that a no-motion condition is more likely but may make weight measurement less precise.

Timeout

Defines the period (in seconds) after which the indicator stops attempting to perform a function that requires a no-motion condition (such as a zero or tare command) and aborts the function. This timeout is used regardless of the source of the command such as the keypad, discrete input, PLC/DCS or web interface. Values from 0 to 99 seconds are possible with the default value being 3 seconds. A smaller value means that less time will be used to check for no-motion before aborting a command. When a value of 0 is entered, there must be no-motion when a command is given or it will fail immediately.

3.5.3. Scale – Precision

Precision scale type covers a wide range of smart weighing sensors. The IND360 has varying capabilities to setup the scale settings for Precision type scales. Not all configuration options listed in this section are available for all devices. The range of possible selections also varies based on the particular weighing sensor connected to IND360. Please note that IND360 can function as a pass-through device to allow a PC to connect to APW-Link via the IP address of the IND360 service port. For more details on how to configure the scale, please refer to the user manual for the connected Precision scale.

3.5.3.1. Type

The Scale Type screen permits a name to be assigned to the scale, displays the scale type, provides a selection list for the Approval mode, and allows entry of the approval class.

3.5.3.1.1. Name

The Name field enables entry of the scale identification. Enter the scale name (an alphanumeric string of up to 12 characters) in the Name entry box.

- 3.5.3.1.2. Scale Type
The Scale Type field indicates which type of scale this indicator supports.
- 3.5.3.1.3. Approval
Approval refers to the metrological (weights and measures) approval configuration for the specific scale. The selection list includes:
None [default], USA, OIML, Canada
"None" is the recommended setting when the IND360 is part of an automation system.
When the approval is configured as USA, OIML (countries outside of USA and Canada), or Canada and the metrology security switch, SW1-1, is set to ON, access to the Scale setup parameters in the menu tree and web interface will be limited to view only.
When an approval is selected but SW1-1 is not ON, it will not be possible to leave setup, and a message will appear: "Switch UNSECURED".
- 3.5.3.1.4. Class
The Class field selection is shown when the Precision scale indicator is selected as approved. This selection must match the Weights and Measures approval class when the indicator is used in an approved mode. The selections are:
III [default], II
- 3.5.3.2. Capacity and Increment
Use the Capacity and Increment setup screen to select scale units, scale capacity and readability.
- 3.5.3.2.1. Capacity
Precision scales will, in many cases, have a hard-coded capacity that cannot be changed by the user. That value is listed here.
- 3.5.3.2.2. Unit
Select the unit value for the scale. Possible units vary depending on what the connected Precision scale supports. Possible options include:
Grams (g), Kilograms (kg), tonnes (t), milligrams (mg), Microgram (ug), Pounds (lb)
- 3.5.3.2.3. Readability
Select the readability of the scale. The readability is the number of divisions (smallest measurable increment of the scale) to be displayed. 1 division provides the maximum readability but may show inconsequential noise in some applications. Readability options vary depending on the particular Precision scale connected to IND360.
- 3.5.3.3. Calibration (Adjustment)
The Calibration (adjustment) menu allows for the user to Test the precision of the scale or to perform a scale adjustment
- 3.5.3.3.1. Test
Use this menu to test the accuracy of the scale against a known test weight.

Mode

Select whether the test will be conducted using either an external test weight placed on the scale or an internal test weight. Please note that not all Precision scales have an internal weight built in.

Weight

Weight of either the external test weight placed on the scale or the internal weight used for the test.

Start Test

Select this option to begin the test. Instructions for when to place and clear the weights will be displayed during an external test. The Precision scale will automatically place and remove the internal test weight once the test begins. Once the test completes, the screen will display the expected result (test weight value), the actual result and the deviation between expected and the result (in %).

3.5.3.3.2. Adjustment

Use this menu to adjust the scale against a known test weight.

Mode

Select whether the adjustment will be conducted using either an external test weight placed on the scale or an internal test weight. Please note that not all Precision scales have an internal weight built in.

Step Control

With Step Control turned on, the user will be prompted to clear the scale or place the test weight on the scale. At each step, the user must confirm that the weight has either been placed on or cleared from the scale.

With Step Control turned off, the user will be prompted to clear the scale or place the test weight, but the IND360 will detect when this occurs and automatically begin the adjustment without the user confirmation.

Adjustment (weight value)

Weight of either the external test weight placed on the scale, or the internal weight used for the test.

Start Adjust

Select this option to begin the adjustment. Instructions for when to place and clear the weights will be displayed during an external adjustment. The Precision scale will automatically place and remove the internal test weight once the internal adjustment begins. Once the adjustment completes, the screen will display the deviation between the old adjustment value and the new adjustment value.

3.5.3.4. Filter

Vibration introduces instability into your system. It is always recommended to attempt to mechanically isolate your scale from its surroundings. The Filter section offers three settings to electronically filter vibration: Cut-off Frequency, Weighing Mode and Environment. Some of the options for filtering may vary based on the connected Precision scale. In that case, please refer to the user manual for the connected Precision scale for additional details.

- 3.5.3.4.1. Cut-off Frequency
- Marks the point at which the filtering process begins to affect the disturbance. Disturbances above the limit frequency will have filtering applied. Recommendation is to start at 20 Hz and reduce the frequency only after adjusting the environment setting. The lower the frequency, the better the disturbance rejection, but it will increase latency.
- 3.5.3.4.2. Weighing Mode
- The Weighing Mode selects the type of filtering to be applied. Available options vary greatly depending on the scale. Please see the user manual for the connected Precision scale for additional details.
- 3.5.3.4.3. Environment
- Sets the level of attenuation applied to the signal above the cut-off frequency frequency. A very stable environment will have the least attenuation applied to the signal and a very unstable environment will have the strongest attenuation. It is recommended to adjust this value first when changing filter settings. Start with "very stable" and work your way down. Possible selections are:
- Very Stable, Stable, **Standard** [default], Unstable, Very Unstable

3.5.4. **Reset**

The Reset screen enables Scale branch setup values to be reset to factory default settings.

To initiate a reset, press the RESET button. When the reset is successful, a verification message that reads "Setting Successful" displays. If the reset was not successful, an error message that reads "Reset Failure" displays. If the reset fails, try to initiate the reset again. If the reset continues to fail, contact a local METTLER TOLEDO representative for assistance.

- Scale Reset does NOT include the reset of metrologically significant parameters – scale type, approval, weight units, capacity, increment, or adjustment data. This data is reset only by performing a Master Reset with switch 2-1 in its ON position.

3.6. **Application**

Use application setup screens to configure the setup parameters shown in the following sections.

3.6.1. **Alibi Memory**

The Alibi memory table stores basic transaction information which cannot be modified by the user. The Alibi memory table can be accessed in the Maintenance section of the Web Interface . Alibi memory is configured as a "ring" buffer that overwrites the oldest record when it reaches its memory limit. Alibi memory can hold approximately 27,000 transactions before it reaches its limit and begins overwriting old transactions. The selections are:

Disabled [default], Enabled

- When the IND360 automation indicator has been configured as **Approved**, Alibi memory enabling or disabling is only accessible when the security switch (SW1-1) is in the OFF position.
- To clear the Alibi memory table, disable the Alibi memory, then re-enable it.

3.6.2. Accessing Alibi Records from IND360 Display

To meet regulatory requirements in some regions, it must be possible to access the alibi records from the local device display. To do this, alibi memory must be enabled. Please note that, while the full alibi record can be exported via the web interface, when the table is viewed on the local IND360 display it is only possible to view one record at a time.

Alibi memory	
Alibi memory	Enabled
Record ID Input	2
Transaction	2
Time	2023/9/12:31:56

Figure 3-26 First page of alibi memory record

Alibi memory	
Gross	9.320
Net	2.000
Tare	7.230
Unit	kg

Figure 3-27 Second page of alibi memory record

Alibi memory	
Tare mode	T

Figure 3-28 Third Page of alibi memory record

- 3.6.2.1. Record ID Input
- When alibi memory is enabled, Record ID Input is the only field that can be modified. Set this field equal to the transaction record you would like to view. Once entered, the alibi memory record requested will be displayed.
- 3.6.2.2. Transaction
- The transaction field will display the transaction number for the current alibi memory record being displayed.
- 3.6.2.3. Time
- Timestamp from IND360 when the alibi memory record was created.
- 3.6.2.4. Gross, Net, Tare
- The gross weight, net weight and tare weight recorded when the alibi memory record was created.
- 3.6.2.5. Unit
- Weighing unit in use when the alibi memory record was created.
- 3.6.2.6. Tare Mode
- Indicates the tare mode in use when the alibi memory record was created. "T" if a standard tare was taken. "PT" if a preset tare was used

3.6.3. Comparators

The Comparators screen permits the configuration of simple comparators controlled by comparison to a limit value and used as an assignment for discrete outputs. The source for comparison can be the Gross Weight, Displayed Weight or Absolute Displayed Weight.

This screen displays all possible Comparators, and contains Description, Source, Limit, High Limit, and Operator condition.

Once parameters have been set in the Comparator Edit screen, they can be saved by pressing "Set".

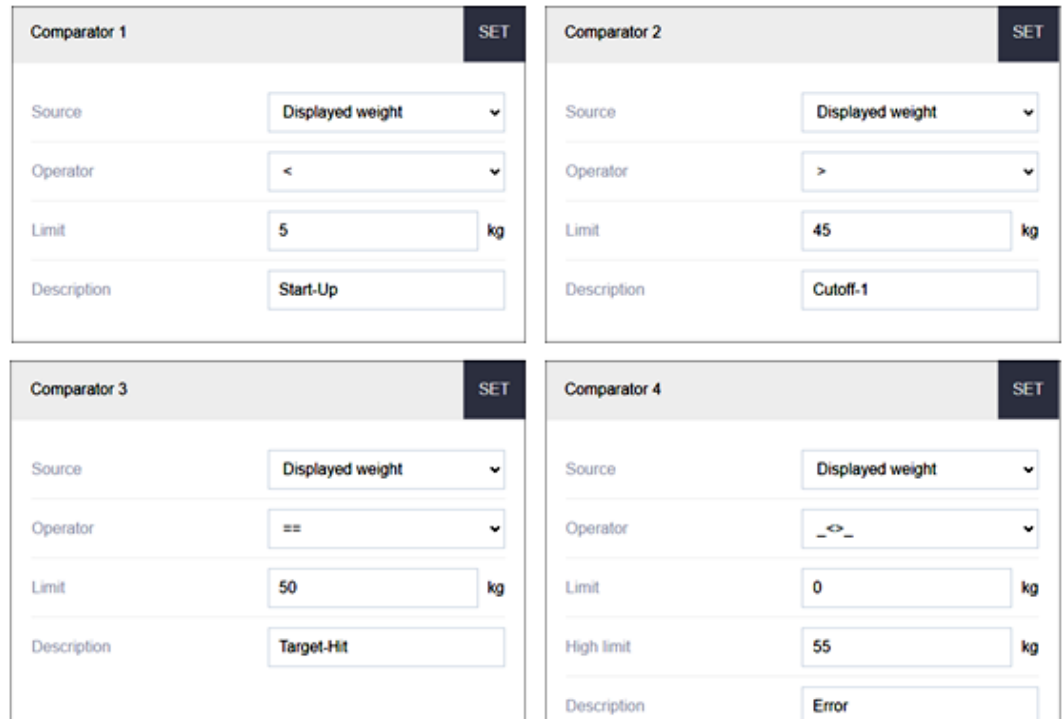

Figure 3-29: Web Interface Comparators Screen

3.6.3.1.1. Comparators 1-8

Source

When a weight field is selected as the Source, the weight unit will be primary units. The choices for Source include:

- None** [default] Comparator disabled
- Displayed Weight Comparator triggered on the displayed weight. Displayed weight will either be Gross or Net, depending on whether a tare was performed.
- Gross Weight Comparator triggered on the gross weight
- ABS-Displayed Weight Comparator triggered on the absolute value of the displayed weight

Operator

The Operator setting determines how the source field will be compared to the limit value or the range between the limit and high limit values.

- < [default] Comparator will be "ON" when the source value is less than the limit
- <= Comparator will be "ON" when the source value is less than or equal to the limit
- = Comparator will be "ON" when the source value is equal to the limit
- >= Comparator will be "ON" when the source value is greater than or equal to the limit
- > Comparator will be "ON" when the source value is greater than the limit
- < > Comparator will be "ON" when the source value is not equal to the limit
- _< >_ Comparator will be "ON" when the source value is outside the range of the limit and the high limit
- >_ <_ Comparator will be "ON" when the source value is within the range of the limit and the high limit

Comparator Description

The description is an alphanumeric string that is used to identify the type and purpose of the comparator. The maximum length is 12 characters.

Limit

The Limit either sets the comparison value to which the actual source value is compared, or the lower comparison value for the range to which the currently measured source value is compared.

High Limit

The High Limit is available only for Range modes such as " $_<>_$ " or " $>__<$ ", and sets the upper comparison value for the range to which the currently measured source value is compared. Its value must be higher than the Limit.

3.6.4. Discrete I/O

These screens provide access to the assignments for discrete inputs and discrete outputs.

3.6.4.1. Discrete Input 1-5

The Discrete Inputs screen displays discrete input assignments, including the input assignment and polarity. Up to 5 inputs can be available for the IND360. After making selections for each input, press "Set" to save the settings to the IND360.

The screenshot displays four panels for configuring discrete inputs 1 through 4. Each panel includes a 'Trigger mode' dropdown menu and an 'Assignment' dropdown menu, with a 'SET' button in the top right corner.

Discrete input 1	Discrete input 2	Discrete input 3	Discrete input 4
Trigger mode: Rising edge	Trigger mode: Rising edge	Trigger mode: Rising edge	Trigger mode: Rising edge
Assignment: Tare	Assignment: Clear tare	Assignment: Print	Assignment: Zero

Figure 3-30: Web Interface Discrete Inputs Screen

3.6.4.1.1. Trigger Mode

The inputs can be programmed to accept either a Rising Edge or Falling Edge as "ON". When Trigger Mode is Rising Edge, the input will be "ON" when the voltage level goes from low to high. When Trigger Mode is Falling Edge, the input will be "ON" when the voltage level goes from high to low.

3.6.4.1.2. Assignment

Use the Assignment selection box to select the input assignment. When the input is triggered, the assigned operation is executed. Selections are:

None [default], Tare, Zero, Print, Clear Tare, Keypad Disable, Keypad Enable

3.6.4.2. Discrete Output

The Discrete Output section displays discrete output assignments. Up to 8 outputs are available depending on the selected option. After selecting all output assignments, press "Set" to save the settings to the IND360.

3.6.4.2.1. Output 1-8

Select the output assignment. Possible selections are:

None [default], Over Capacity, Under Zero, Motion, Net, Comparator 1-8, Smart5 Red, Smart5 Orange

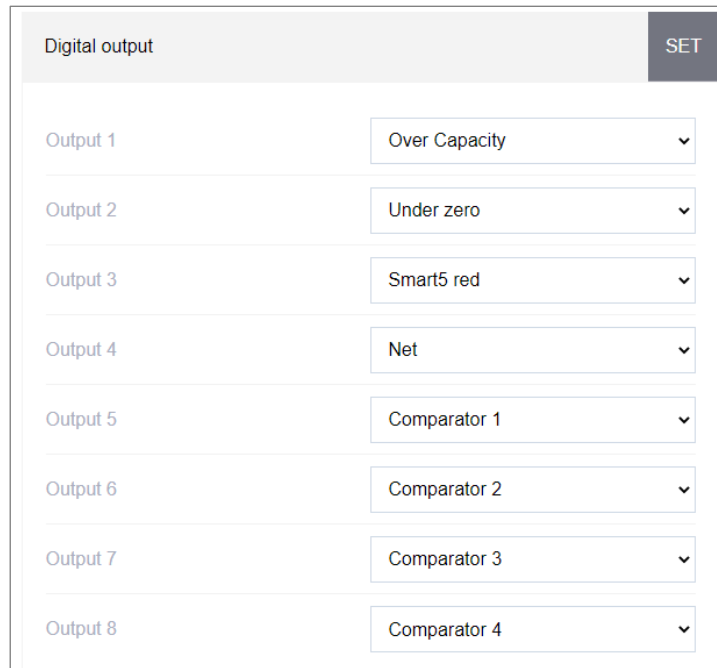

Figure 3-31: Web Interface Digital Output Screen

3.6.5. PAC (Application Pack) Management

When the IND360 is used with a built-in application, such as IND360tank/vessel, IND360fill/dose, IND360rate control, IND360legacy or IND360dynamic, the name of the application will be available in the Application branch of the web interface. This is where the application can be enabled or disabled. Once enabled, options to configure the application via the web interface will become visible. For more details, please refer to the dedicated application manual for the specific application.

3.6.6. Reset

The Reset function returns most configuration settings in the Application branch to their factory defaults.

To initiate a reset, press the Reset button. When the reset is successful, a verification message that reads "Setting Successful" displays. If the reset was not successful, an error message that reads "Reset Failure" displays. If the reset fails, try to initiate the reset again. If the reset continues to fail, contact a local METTLER TOLEDO representative for assistance.

- **Application > Reset** does NOT include reset information stored in Alibi Memory or tables. This data can only be reset by executing the Reset All function found at **Maintenance > Reset**.

3.7. Terminal

When user security is enabled, Login must be at Maintenance level or above to access most parameters in the Terminal branch.

3.7.1. Device

Device displays the model and serial number for the IND360.

3.7.2. Display

Use the Display setup section to configure settings for the Screensaver, Backlight Adjustment, and Language.

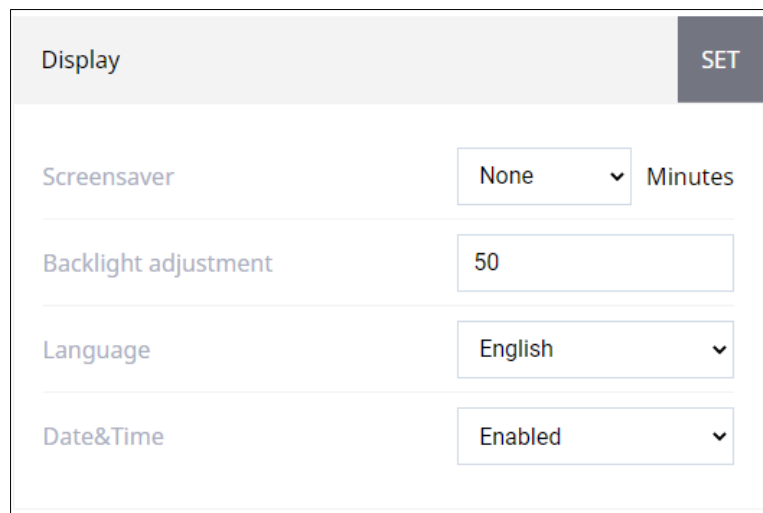

The screenshot shows a web interface titled "Display" with a "SET" button in the top right corner. Below the title, there are four configuration rows, each with a label on the left and a control on the right:

- Screensaver:** A dropdown menu currently showing "None" and a "Minutes" label to its right.
- Backlight adjustment:** A text input field containing the number "50".
- Language:** A dropdown menu currently showing "English".
- Date&Time:** A dropdown menu currently showing "Enabled".

Figure 3-32: Web Interface Display Screen

3.7.2.1. Screensaver

The screensaver setting determines the number of minutes (None, 1, 5, 10 or 30 minutes) that must elapse with no keypad activity before the screensaver is shown.

During runtime, when any key is pressed, the screen saver automatically stops and its timer is reset. The button used to exit the screen saver mode is ignored for all other purposes.

3.7.2.2. Backlight Adjustment

Backlight Adjustment allows for the selection (1-100) of the brightness of the display. A value of 1 provides the lowest brightness. A value of 100 provides the highest brightness.

3.7.2.3. Language

Select the language to be used on the IND360 display. Possible selections are:

English [default], Chinese, German, French, Spanish, Italian

3.7.2.4. Date & Time

Select whether to display the date and time on the IND360 display. Possible selections are:

Enabled [default], Disabled

3.7.3. Region

The region setup screens enable configuration of the time and date.

Region		SET
Time	17:59:16	
Time format	24:MM:SS	
Date	01 11 2020	
Date format	DD MM YYYY	
Minute	57	
Hour	17	
Day	1	
Month	11	
Year	2020	

Figure 3-33: Web Interface Region Screen

3.7.3.1. Time Format

Possible selections are:

24:MM:SS [default] 24-hour clock with hour, minutes, and seconds displayed

3.7.3.2. Date Format

Possible selections are:

DD MM YYYY [default] Two-digit day, two digit month, four-digit year

3.7.3.3. Set Time & Date

Enter the hour, minutes, day, month, and year in this section’s text fields. A battery backup maintains the time and date settings in the event of a power outage.

- When needed, the time must be manually adjusted for daylight savings time. The IND360 does not make this adjustment automatically.

3.7.4. Keypad

Use the Keypad settings to either enable or disable the keypad of the IND360. With the keypad disabled, the buttons on the front of the device have no effect until the keypad is enabled again. The keypad can only be enabled via the web interface or a configured input.

3.8. Communication

Configuration of the following functions is managed on the Communication screen.

3.8.1. Service

3.8.1.1. Access/Security

Control whether to allow access to the Web Interface, PC Application or the ePrint functionality.

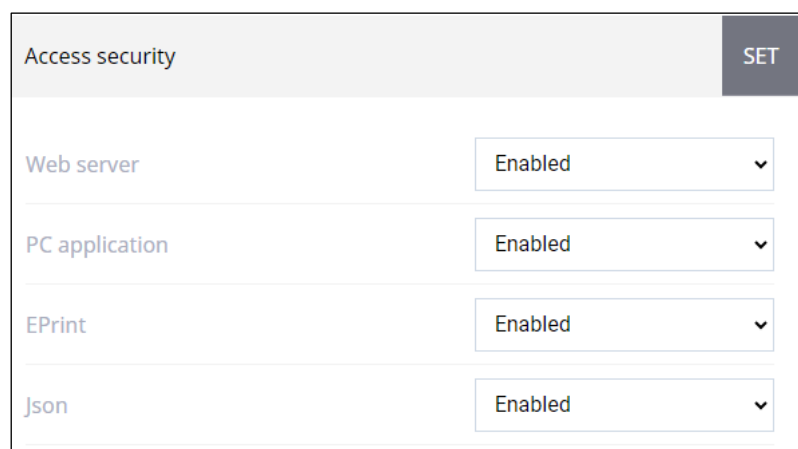

Figure 3-34: Web Interface Access Security Screen

3.8.1.1.1. Web Server

Web Server is the main method to configure IND360 settings. This function can be disabled via the web interface or local display for security purposes. Once disabled, the web interface must be enabled via the local display. Choices are:

Disabled, **Enabled** [default]

3.8.1.1.2. PC Application

PC Application refers to the functionality that allows a custom PC application to communicate with the IND360 via TCP/IP. Choices are:

Disabled, **Enabled** [default]

3.8.1.1.3. ePrint

ePrint is triggered via configured discrete input, PLC command or when the Print key on the display is pressed. When enabled, ePrint will send weight, date and time information to a PC via TCP/IP. Choices are:

Disabled, **Enabled** [default]

3.8.1.1.4. APW-Link (Precision version only)

APW-Link is a free software tool available from www.mt.com that can be used to configure and optimize the performance of APW scales. The IND360 can be used as a "pass-through" device to communicate from the PC to the Precision scale connected to the IND360 so no rewiring of the scale is needed to use the APW-Link software. Simply connect to the IP address of the service port of the IND360 in APW-Link.

3.8.1.1.5. JSON

Allows IND360 to receive JSON read requests via the Service Ethernet port. Please see the JSON section of this document for information on all currently supported JSON commands.

3.8.1.2. Port

Set the individual port numbers for web interface (recommended to keep at 80), PC application, ePrint and APW Link (Precision version only) connections.

Port		SET
Web server	<input type="text" value="80"/>	
PC application	<input type="text" value="1026"/>	
EPrint	<input type="text" value="1025"/>	

Figure 3-35: Web Interface Port Screen

3.8.1.3. Service Ethernet (TCP/IP)

Service ethernet		SET
MAC address	<input type="text" value="00:00:00:00:00:00"/>	
IP address	<input type="text" value="192.168.0.20"/>	
Subnet mask	<input type="text" value="255.255.255.0"/>	
Gateway address	<input type="text" value="192.168.0.1"/>	

Figure 3-36: Web Interface Service Ethernet Screen

3.8.1.3.1. MAC Address Service

The Media Access Control (MAC) Address cannot be edited; it is shown for informational purposes only.

3.8.1.3.2. IP Address Service

Enter the IP address for the IND360 automation indicator. The default value for the IP is 192.168.0.8.

- 3.8.1.3.3. Subnet Mask Service
Enter the subnet mask (or view when DHCP Client is enabled) for the IND360 automation indicator. The default value for the subnet mask is 255.255.255.0.
- 3.8.1.3.4. Gateway Address Service
Enter the gateway address (or view when DHCP Client is enabled) for the IND360 automation indicator. The default value for the gateway is blank.

3.8.2. Analog Output (only available when installed on IND360)

The IND360 automation indicator's analog output option provides a 4-20 mA or 0-10 V output corresponding to the scale weight. The output can be configured to represent different source values.

The resolution of the analog output is 16 bit, whereas the output of the weight over the automation interface is 32bit. Therefore, these weight values will not exactly match due to the difference in resolution and uncertainties in the A/D and D/A conversion.

The IND360's analog output will allow values below 4mA when the scale indicates weight below zero and values above 20mA when the weight is above the adjusted capacity.

3.8.2.1. Analog Output

Allows for the setting of the analog output Source, Output Type, Zero Value, and Full Scale Value.

3.8.2.1.1. Source

This parameter determines what data will be used as the source of the analog output. Selections include:

None [default]	Analog output signal disabled
Gross weight	Analog output signal corresponds to the gross weight
Displayed weight	Analog output signal corresponds to the displayed weight
ABS-displayed weight	Analog output signal corresponds to the absolute value of the displayed weight

3.8.2.1.2. Output Type

Choose the operating mode and range for the analog output signal. Selections include:

4-20 mA [default], 0-10 V

3.8.2.1.3. Zero Value

The beginning zero value for the analog output can be adjusted. In the Zero Value field, enter the weight value at which the "zero" (4mA or 0 VDC) output of the analog signal should occur.

3.8.2.1.4. Full Scale Value

The full scale span value for the analog output can be adjusted. In the Full Scale Value field, enter the weight value at which the "full scale span" (20mA or 10 VDC) output of the analog signal should occur.

3.8.2.2. Zero Adjustment

When the analog output zero value does not provide the exact output required, it may be trimmed as follows:

1. Press one of the zero output adjustment buttons to begin the zero fine-tuning operation. A warning message appears to confirm that the user would like to perform a zero output adjustment. Please note that once started, the analog output will output a zero signal regardless of the weight currently on the scale. Use the buttons that display to adjust the signal if necessary as follows:



Bump Down (fast adjustment down)



Nudge Down (slow adjustment down)



Bump Up (fast adjustment up)



Nudge Up (slow adjustment up)

2. Once zero output is adjusted satisfactorily, save the setting to the IND360.

3.8.2.3.

Full Adjustment

When the analog output full span value does not provide the exact output required, it may be trimmed as follows:

Press one of the SPAN output adjustment buttons to begin the SPAN fine-tuning operation. A warning message appears to confirm that the user would like to perform a SPAN output adjustment. Please note that once started, the analog output will output a signal corresponding to full SPAN value regardless of the weight currently on the scale. Use the buttons that display to adjust the signal if necessary as follows:



Bump Down (faster adjustment down)



Nudge Down (slower adjustment down)



Bump Up (faster adjustment up)



Nudge Up (slower adjustment up)

Once the span is adjusted satisfactorily, save the setting to the IND360.

3.8.3.

EtherNet/IP (only available when Industrial Ethernet option installed on IND360)

These parameters are used to configure the operation of the EtherNet/IP option board.

Industrial ethernet		SET
Type	EtherNet/IP	▼
Format	2 block format	▼
Data OK Mode	Standard	▼
Byte order	Automatic	▼
Supervision	Disable	▼
MAC address	00:10:52:D4:7E:C6	
DHCP	Disabled	▼
IP address	192.168.0.2	
Subnet mask	255.255.255.0	
Gateway address	0.0.0.0	

Figure 3-37: Web Interface EtherNet/IP Screen

3.8.3.1. Format EtherNet/IP

Select either **2 Block Format** [default] or 8 Block format for SAI communication to the automation system. 8 Block provides more cyclical data to the automation system at a time (e.g. provide gross weight, net weight and tare weight all in one cycle). The 2 Block format is useful for lean systems or older PLCs that have limitations of number of devices and amount of data.

3.8.3.2. Data OK Mode

Data OK Mode selects when the Data OK bit of the IND360 goes low. Options for this Mode are "Standard" or "Commercial (LFT)". It is recommended to use Standard when IND360 is not involved in a commercial, legal-for-trade weighing process. Data OK should always be monitored in the automation system in conjunction with Smart5 and any status bits critical to the performance and safety of your specific application.

3.8.3.3. Byte Order EtherNet/IP

Under normal circumstances such as communication with a Rockwell PLC, this setting must be set to automatic. When communicating to a device from another manufacturer using a different byte order this setting allows you to configure the system to the manufacturer's specification.

Choices are:

Automatic [default], Big Endian, Little Endian, Word Swap, Byte Swap

3.8.3.4. Supervision EtherNet/IP

A Smart5 alarm occurs whenever cyclic communication is not established between IND360 and the PLC. To avoid nuisance alarms, this supervision of the PLC connection can be disabled during commissioning, or when the IND360 is being used in a standalone configuration without a PLC.

Choices are:

Enabled [default], Disabled

3.8.3.5. MAC Address EtherNet/IP

The Media Access Control (MAC) Address cannot be edited; it is shown for informational purposes only.

3.8.3.6. DHCP

When DHCP (Dynamic Host Configuration Protocol) is enabled, the IP Address, Subnet Mask, and Gateway Address fields are assigned automatically by the network. They become read-only in the setup screens. When disabled, the IP address must manually be assigned in the following fields. Choices are:

Disabled [default], Enabled

3.8.3.7. IP Address EtherNet/IP

Enter the IP address (or view when DHCP Client is enabled) for the IND360 automation indicator. The default value for the IP is 192.168.0.2.

3.8.3.8. Subnet Mask EtherNet/IP

Enter the subnet mask (or view when DHCP Client is enabled) for the IND360 automation indicator. The default value for the subnet mask is 255.255.255.0.

3.8.3.9. Gateway Address EtherNet/IP

Enter the gateway address (or view when DHCP Client is enabled) for the IND360 automation indicator. After each group of digits has been entered, press ENTER to proceed to the next group. The default value for the gateway is blank.

3.8.4. PROFIBUS DP (only available when installed on IND360)

The PROFIBUS DP Interface supports discrete data transfer that enables bi-directional communication of discrete bit-encoded information or 16-bit binary word (signed integer) numerical values.

3.8.4.1. Node Address PROFIBUS DP

Each IND360 Automation indicator connected to the network represents one physical node. This address is determined by the system designer, then configured in the IND360 Automation indicator by entering the appropriate node address (1–125). The default value is 1.

3.8.4.2. Format Profibus DP

Select either **2 Block Format** [default] or **8 Block** format for SAI communication to the automation system. **8 Block** provides more cyclical data to the automation system at a time (e.g. provide gross weight, net weight and tare weight all in one cycle). The **2 Block** format is

useful for lean systems or older PLCs that are limited in the number of devices and amount of data possible.

3.8.4.3. Byte Order Profibus DP

Under normal circumstances, such as communication with a Siemens PLC, this setting must be set to automatic. When communicating to a device from another manufacturer using a different byte order, this setting allows the system to be configured to the manufacturer's specification.

Choices are:

Automatic [default], Big Endian, Little Endian, Word Swap, Byte Swap

3.8.4.4. Supervision Profibus DP

A Smart5 alarm occurs whenever cyclic communication is not established between IND360 and the PLC. To avoid nuisance alarms, this supervision of the PLC connection can be disabled during commissioning, or when the IND360 is being used in a standalone configuration without a PLC.

Choices are:

Enabled [default], Disabled

3.8.5. PROFINET (only available when Industrial Ethernet option installed on IND360)

These parameters are used to configure the operation of the PROFINET option board.

Industrial ethernet		SET
Type	Profinet	▼
Format	2 block format	▼
Data OK Mode	Standard	▼
Byte order	Automatic	▼
Supervision	Disable	▼
MAC address	00:10:52:D4:7E:C6	
IP address	192.168.0.2	
Subnet mask	255.255.255.0	
Gateway address	0.0.0.0	
Device name	ind360-1	

Figure 3-38: Web Interface PROFINET Screen

- 3.8.5.1. Format PROFINET
- Select either **2 Block Format** [default] or **8 Block** format for SAI communication to the automation system. **8 Block** can provide more cyclic data to the automation system at a time (e.g. provide gross weight, net weight and tare weight all in one cycle). The **2 Block** format is useful for lean systems or for older PLCs that have limitations of number of devices and amount of data.
- 3.8.5.2. Data OK Mode
- Data OK Mode selects when the Data OK bit of the IND360 goes low. Options for this Mode are "Standard" or "Commercial (LFT)". It is recommended to use Standard when IND360 is not involved in a commercial, legal-for-trade weighing process. Data OK should always be monitored in the automation system in conjunction with Smart5 and any status bits critical to the performance and safety of your specific application.
- 3.8.5.3. Byte Order PROFINET
- Under normal circumstances such as communication with a Siemens PLC this setting must be set to automatic. When communicating with a device from another manufacturer using a different byte order this setting allows you to configure the system to the manufacturer's specification.
- Choices are:
- Automatic** [default], Big Endian, Little Endian, Word Swap, Byte Swap
- 3.8.5.4. Supervision PROFINET
- A Smart5 alarm occurs whenever cyclic communication is not established between IND360 and the PLC. To avoid nuisance alarms, this supervision of the PLC connection can be disabled during commissioning, or when the IND360 is being used in a standalone configuration without a PLC.
- Choices are:
- Enabled** [default], Disabled
- 3.8.5.5. MAC Address PROFINET
- The Media Access Control (MAC) Address cannot be edited; it is shown for information only.
- 3.8.5.6. IP Address PROFINET
- Enter the IP address for the IND360 automation indicator. The default value for the IP is 192.168.0.2.
- 3.8.5.7. Subnet Mask PROFINET
- Enter the subnet mask for the IND360 automation indicator. The default value for the subnet mask is 255.255.255.0.
- 3.8.5.8. Gateway Address PROFINET
- Enter the gateway address for the IND360 automation indicator. The default value for the gateway is blank.

3.8.5.9. Device Name PROFINET

This setting shows the device name assigned by the automation system or allows the IND360 to set the device name used by the automation system.

3.8.6. EtherCAT (only available when Industrial Ethernet option installed on IND360)

These parameters are used to configure the EtherCAT option board.

Industrial ethernet		SET
Type	EtherCAT	▼
Format	2 block format	▼
Data OK Mode	Standard	▼
Byte order	Automatic	▼
Supervision	Disable	▼
Device ID	0	

Figure 3-39 Web Interface EtherCAT screen

3.8.6.1. Format EtherCAT

Select either **2 Block Format** [default] or 8 Block format for SAI communication to the automation system. 8 Block can provide more cyclic data to the automation system at a time (e.g. provide gross weight, net weight and tare weight all in one cycle). The 2 Block format is useful for lean systems or for older PLCs that have limitations of number of devices and amount of data.

3.8.6.2. Data OK Mode

Data OK Mode selects when the Data OK bit of the IND360 goes low. Options for this Mode are "Standard" or "Commercial (LFT)". It is recommended to use Standard when IND360 is not involved in a commercial, legal-for-trade weighing process. Data OK should always be monitored in the automation system in conjunction with Smart5 and any status bits critical to the performance and safety of your specific application.

3.8.6.3. Byte Order EtherCAT

Under normal circumstances such as communication with a Beckhoff PLC this setting must be set to automatic. When communicating with a device from another manufacturer using a different byte order this setting allows you to configure the system to the manufacturer's specification.

Choices are:

Automatic [default], Big Endian, Little Endian, Word Swap, Byte Swap

3.8.6.4. Supervision EtherCAT

A Smart5 alarm occurs whenever cyclic communication is not established between IND360 and the PLC. To avoid nuisance alarms, this supervision of the PLC connection can be disabled during commissioning, or when the IND360 is being used in a standalone configuration without a PLC.

Choices are:

Enabled [default], Disabled

3.8.6.5. Device ID EtherCAT

Sets the EtherCAT Device ID for IND360. Device ID must be unique in EtherCAT network if ID is to be used.

3.8.7. Modbus TCP (only available when Industrial Ethernet option installed on IND360)

These parameters are used to configure the settings for Modbus TCP communication.

Industrial ethernet		SET
Type	Modbus TCP	▼
Data OK Mode	Standard	▼
Byte order	Automatic	▼
Supervision	Disable	▼
MAC address	00:10:52:D4:7E:C6	
DHCP	Disabled	▼
IP address	192.168.0.2	
Subnet mask	255.255.255.0	
Gateway address	0.0.0.0	

Figure 3-40: Web Interface Modbus TCP Screen

3.8.7.1. Data OK Mode

Data OK Mode selects when the Data OK bit of the IND360 goes low. Options for this Mode are "Standard" or "Commercial (LFT)". It is recommended to use Standard when IND360 is not involved in a commercial, legal-for-trade weighing process. Data OK should always be monitored in the automation system in conjunction with Smart5 and any status bits critical to the performance and safety of your specific application.

3.8.7.2. Byte Order Modbus TCP

Under normal circumstances should be set to automatic. When communicating with a device from a manufacturer using a different byte order this setting allows you to configure the system to the manufacturer's specification.

Choices are:

Automatic [default], Big Endian, Little Endian, Word Swap, Byte Swap

3.8.7.3. Supervision Modbus TCP

A Smart5 alarm occurs whenever cyclic communication is not established between IND360 and the PLC. To avoid nuisance alarms, this supervision of the PLC connection can be disabled during commissioning, or when the IND360 is being used in a standalone configuration without a PLC.

Choices are:

Enabled [default], Disabled

3.8.7.4. MAC Address Modbus TCP

The Media Access Control (MAC) Address cannot be edited; it is shown for information only.

3.8.7.5. IP Address Modbus TCP

Enter the IP address for the IND360 automation indicator. The default value for the IP is 192.168.0.2.

3.8.7.6. Subnet Mask Modbus TCP

Enter the subnet mask for the IND360 automation indicator. The default value for the subnet mask is 255.255.255.0.

3.8.7.7. Gateway Address Modbus TCP

Enter the gateway address for the IND360 automation indicator. The default value for the gateway is blank.

3.8.8. CC-Link IE (only available when Industrial Ethernet option installed on IND360)

These parameters are used to configure the operation of the CC-Link IE option board.

Industrial ethernet		SET
Type	CC-Link IE	▼
Format	2 block format	▼
Data OK Mode	Standard	▼
Byte order	Automatic	▼
Supervision	Disable	▼
MAC address	00:10:52:D4:7E:C6	
IP address	192.168.0.2	
Subnet mask	255.255.255.0	
Gateway address	0.0.0.0	

Figure 3-41: Web Interface CC-Link IE Screen

3.8.8.1. Format CC-Link IE

Select either **2 Block Format** [default] or 8 Block format for SAI communication to the automation system. 8 Block can provide more cyclic data to the automation system at a time (e.g. provide gross weight, net weight and tare weight all in one cycle). The 2 Block format is useful for lean systems or for older PLCs that have limitations of number of devices and amount of data.

3.8.8.2. Data OK Mode

Data OK Mode selects when the Data OK bit of the IND360 goes low. Options for this Mode are "Standard" or "Commercial (LFT)". It is recommended to use Standard when IND360 is not involved in a commercial, legal-for-trade weighing process. Data OK should always be monitored in the automation system in conjunction with Smart5 and any status bits critical to the performance and safety of your specific application.

3.8.8.3. Byte Order CC-Link IE

Under normal circumstances should be set to automatic. When communicating with a device from a manufacturer using a different byte order this setting allows you to configure the system to the manufacturer's specification.

Choices are:

Automatic [default], Big Endian, Little Endian, Word Swap, Byte Swap

3.8.8.4. Supervision CC-Link IE

A Smart5 alarm occurs whenever cyclic communication is not established between IND360 and the PLC. To avoid nuisance alarms, this supervision of the PLC connection can be disabled during commissioning, or when the IND360 is being used in a standalone configuration without a PLC.

Choices are:

Enabled [default], Disabled

3.8.8.5. MAC Address CC-Link IE

The Media Access Control (MAC) Address cannot be edited; it is shown for information only.

3.8.8.6. IP Address CC-Link IE

Enter the IP address for the IND360 automation indicator. The default value for the IP is 192.168.0.2.

3.8.8.7. Subnet Mask CC-Link IE

Enter the subnet mask for the IND360 automation indicator. The default value for the subnet mask is 255.255.255.0.

3.8.8.8. Gateway Address CC-Link IE

Enter the gateway address for the IND360 automation indicator. The default value for the gateway is blank.

3.8.9. Modbus RTU (only available when installed on IND360)

These parameters are used to configure the operation of the Modbus RTU option board.

Modbus RTU		SET
Baud rate	9600	▼
Data bits	8 bits	▼
Flow control	None	▼
Parity	None	▼
Bus termination	Disabled	▼
Node address	0	
Byte order	Little endian	▼
Supervision	Disable	▼
Timeout(1-20s)	3	s

Figure 3-42: Web Interface Modbus RTU Screen

3.8.9.1. Modbus RTU

3.8.9.1.1. Baud Rate Modbus RTU

Select the baud rate for the Modbus RTU connection. Higher Baud rates are recommended when installing more than one unit on a Modbus network.

Options are:

300, 600, 1200, 2400, 4800, **9600** [default], 19200, 38400, 57600, 115200

3.8.9.1.2. Data Bits

Select the number of data bits to be used for the Modbus RTU connection. Options are:

7, **8** [default]

3.8.9.1.3. Flow Control

Select Flow Control for Modbus RTU connection. Options are:

None [default], XON/XOFF

3.8.9.1.4. Parity

Select Parity for Modbus RTU connection. Options are:

None [default], Even, Odd

- 3.8.9.1.5. Bus Termination
Select whether to enable or disable Bus Termination for the Modbus RTU connection.
- 3.8.9.1.6. Node Address Modbus RTU
Values from 000 to 255 are accepted with 000 being the default.
- 3.8.9.1.7. Byte Order Modbus RTU
Select the order in which the data bytes and words will be presented for the Modbus RTU connection. Options are:

Little Endian [default], Word Swap, Byte Swap, Big Endian

- 3.8.9.2. Supervision Modbus RTU
There is no standard supervision function for Modbus RTU as for Industrial Ethernet or Profibus DP. However, this parameter provides a possibility to supervise the Modbus RTU communication between IND360 and the PLC. Once enabled, the IND360 expects a periodic signal from the PLC. If the signal does not come within the time defined by the parameter "Timeout", a PLC communication alarm will be triggered.

- Note: The supervision only works when the PLC is programmed so that it sends periodic signals as expected. Otherwise, a communication alarm will always be triggered.

Choices are:

Disabled [default], Enabled

- 3.8.9.3. Timeout Modbus RTU
The maximum time expected between periodic signals from the PLC to the IND360.
- Note: To avoid nuisance alarms, the PLC must send the signal in a period shorter than this parameter.

Choices are:

[1s-20s]

3.8.10. Reset

The Reset setup screen restores Communication branch setup values to their factory default settings.

To initiate a reset, press the Reset button. When the reset is successful, a verification message that reads "Setting Successful" displays. If the reset was not successful, an error message that reads "Reset Failure" displays. If the reset fails, try to initiate the reset again. If the reset continues to fail, contact a local METTLER TOLEDO representative for assistance.

3.9. Maintenance

The maintenance setup branch includes the views and settings described in this section.

3.9.1. Configure/View

The Configure/View setup branch provides access to parameters for Change Log, Maintenance Log, Error Log, Alibi, and Run Flat.

3.9.1.1. Error Log

The Error Log records significant errors that occur in the weighing system. The Error Log is described in more detail in Chapter 4, Service and Maintenance. Press "Clear" to reset this error log. If the reset fails, an error message that reads "Reset Failure" displays. If the reset fails, try to initiate the reset again. If the reset continues to fail, contact a local METTLER TOLEDO service representative for assistance. Press "Export" to create a backup of the current error log. Press "Set" to save the decision to either enable or disable the Error Log.

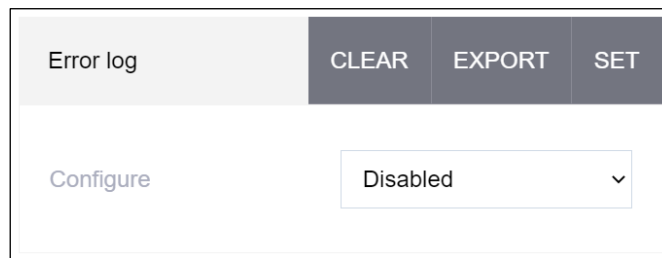

Figure 3-43: Web Interface Error Log Screen

3.9.1.1.1. Configure

Use the selection box to select Disabled or **Enabled** [default] for the Error Log.

3.9.1.2. Change Log

The change log file tracks changes to indicator configuration. Once the Change Log is full, it must be cleared or reset before additional entries (changes to settings and shared data) can be made. Press "CLEAR" to reset the change log. If the reset fails, an error message that reads "Reset Failure" displays. If the reset fails, try to initiate the reset again. If the reset continues to fail, contact a local METTLER TOLEDO service representative for assistance. Press "EXPORT" to create a backup of the current change log. Press "Set" to save the decision to either enable or disable the Change Log.

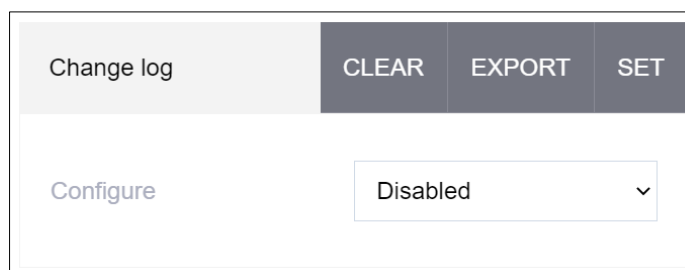

Figure 3-44: Web Interface Change Log Screen

3.9.1.2.1. Configure

Use the selection box to select Disabled or **Enabled** [default] for the Change Log.

3.9.1.3. Maintenance Log

The Maintenance Log tracks information critical for maintenance technicians. Press "Clear" to reset the Maintenance Log. If the reset fails, an error message that reads "Reset Failure" displays. If the reset fails, try to initiate the reset again. If the reset continues to fail, contact a local METTLER TOLEDO service representative for assistance. Press "Export" to create a backup of the current Maintenance Log. Press "Set" to save the decision to either enable or disable the Maintenance Log.

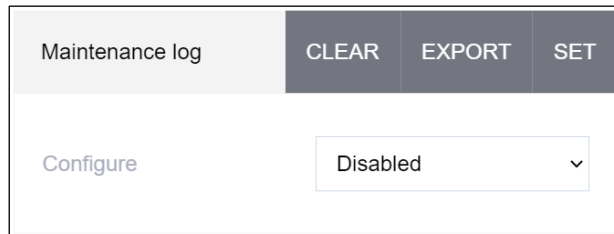

Figure 3-45: Web Interface Maintenance Log Screen

3.9.1.3.1. Configure

Use the selection box to select Disabled or **Enabled** [default] for the Maintenance Log.

3.9.1.4. Alibi

The Alibi function is used to track weighing transactions in legal for trade applications. Press the Export button to generate a log of the current entries in alibi memory.



Figure 3-46: Web Interface Alibi Memory Export Screen

3.9.1.5. RunFlat (POWERCELL® version only)

When IND360 determines that a load cell is operating out of tolerance or fails to detect communication with a single load cell, it can invoke the RunFlat algorithm to compensate for the cell's questionable readings until the cell is replaced. This algorithm is intended for processes with a constant center of gravity. Press "Set" to save the parameters below to the IND360.

Once the overload status has been triggered, it is not automatically reset until the measured weight falls below 90% of the overload threshold value. Press "Clear" to manually reset the overload status before the measured weight drops below 90% of the overload value.

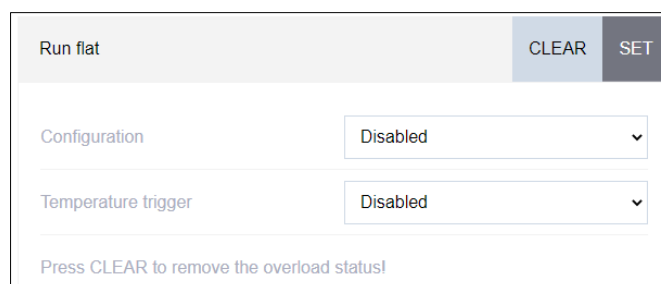

Figure 3-47: Web Interface Run Flat Screen

3.9.1.5.1. Configuration (POWERCELL® version only)

Configure RunFlat to either be off and never turned on, or set to trigger automatically as soon as load cell communication issues are detected. The indicator will automatically exit RunFlat mode once the communication issues are no longer present. Options are:

Disabled [default], Enabled

3.9.1.5.2. Temperature Trigger (POWERCELL® version only)

Use to trigger RunFlat if a load cell is found to be operating outside of its recommended temperature range. Options are:

Disabled [default], Enabled

3.9.1.6. Smart5™

Allows the user to set the limits which trigger the Smart5™ overload or underload alerts in percentage of scale capacity. Choose the value that best suits your application.

- Setting this value too low may lead to nuisance alarms, while setting it too high may lead to safety problems.

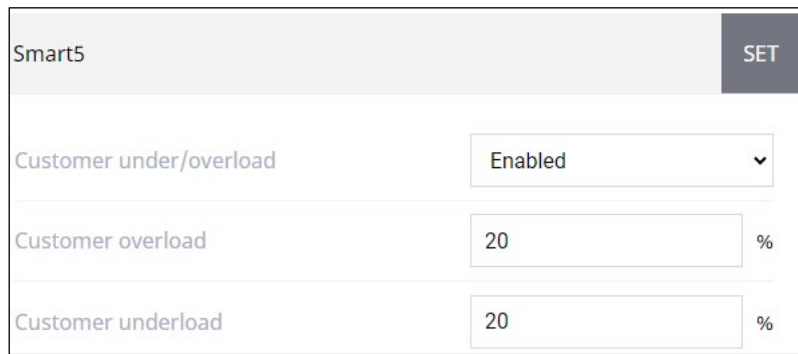

Figure 3-48: Web Interface Smart5™ Screen

3.9.1.6.1. Customer-Defined Overload

Set the percentage above the scale capacity in which the Smart5™ overload alert will be triggered.

3.9.1.6.2. Customer-Defined Underload

Set the percentage under the scale zero value in which the Smart5™ underload alert will be triggered.

3.9.1.7. LC Detection (Analog version only)

IND360 is capable of detecting the resistance of the connected analog load cells. If properly setup, this feature can be used to generate an error when the detected resistance of the load cells appreciably changes (e.g. when a load cell is no longer communicating).

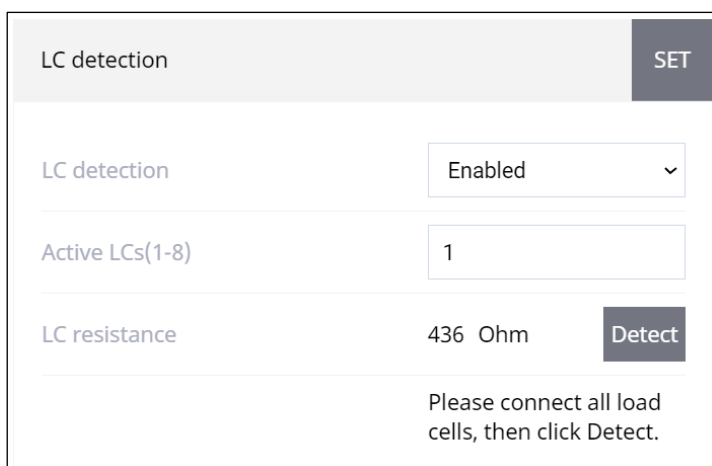

Figure 3-49 Web Interface LC Detection Screen

To setup, once all load cells are connected to IND360 and working properly, enter the number of active load cells in the system. At that point, click "Detect". IND360 will show the load cell resistance detected. Click "Set" to store this value and IND360 will generate an error if the load cell resistance is detected to change significantly in the future.

3.9.2. Run

3.9.2.1. Indicator

Displays the current measurement intervals (counts) in their raw form (no adjustments for zero and sensitivity) for the scale, the summed value for an analog scale, or individual measurement intervals for each load cell for a POWERCELL® scale. Also displays the supply voltage and current for IND360.

Terminal		
Load cell output	000936640	Counts
Supply current	1.7	mA

Figure 3-50: Web Interface Terminal Run Screen

3.9.2.2. Calibration Values

The Calibration (Adjustment) Values screen shows the current adjustment values configured for the scale. The number of test loads that are displayed is determined by the linearity adjustment setting configured for the scale.

This makes it unnecessary to recalibrate the scale with test weights. While this method is quick, it is not as accurate as placing test weights on the scale. Record these adjustment values so that they may be preserved and manually entered into a new replacement unit or board in the unlikely event of failure. As a best practice, confirm the readjustment by calibrating with a traceable test reference to prevent transcription errors.

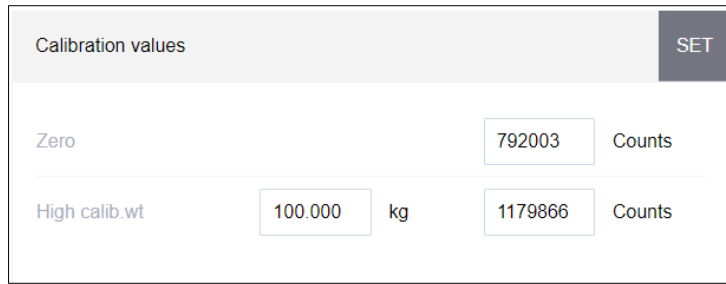

Figure 3-51: Web Interface Calibration (Adjustment) Values Screen

3.9.2.3. Statistics

Displays several read-only statistics that can be extremely useful when diagnosing scale issues.

Statistics	
Weighments	4294967040
Overloads	2
Zero commands	1
Zero failures	1

Figure 3-52: Web Interface Statistics Screen

3.9.2.3.1. Weighments

The total number of weighments (weighing cycles) completed.

3.9.2.3.2. Overloads

The number of times the scale has exceeded the over-capacity blanking value of the scale.

3.9.2.3.3. Zero Commands

The number of times a pushbutton zero command has been attempted.

3.9.2.3.4. Zero Failures

The number of times a pushbutton zero command has failed due to out of zero range or excessive motion when zero command was attempted.

3.9.2.4. Shift Adjust Values (POWERCELL® Version Only)

In a scale with four or more load cells, mechanical shift adjustment (leveling with metal shims) must be performed before performing an electronic shift adjustment, to eliminate repeatability problems.

The Shift Values screen displays the current shift adjustment values for a POWERCELL® scale. The number of shift adjustment values displayed is determined by the selection of shift adjust by cell/pair and the number of load cells addressed.

These values can be recorded and then manually entered into a new replacement board should a failure ever occur. This makes it unnecessary to shift adjust the scale again. While this method is quick, it is not as accurate as placing test weights on the scale.

3.9.2.5. Restore PowerDeck Scale Data (POWERCELL® Version Only)

Press "Start" to load the adjustment data stored in the load cells from the factory. Once this is done, the GEO code should be entered and then the PowerDeck scale is ready for use.

3.9.2.6. POWERCELL (POWERCELL® Version Only)

Displays information read from each individual POWERCELL® load cell. This information includes the serial number of the load cell, the software version, current temperature at the load cell (°C), load cell raw measurement intervals (counts), supply voltage and the gas concentration (only available with certain POWERCELL® load cells).

3.9.2.7. Leveling Guidance (POWERCELL® Version Only)

Leveling guidance for POWERCELL® type floor scales (e.g. PowerDeck®) is only available via the Panel or Harsh type local displays for IND360. This feature is not currently available via the web interface.

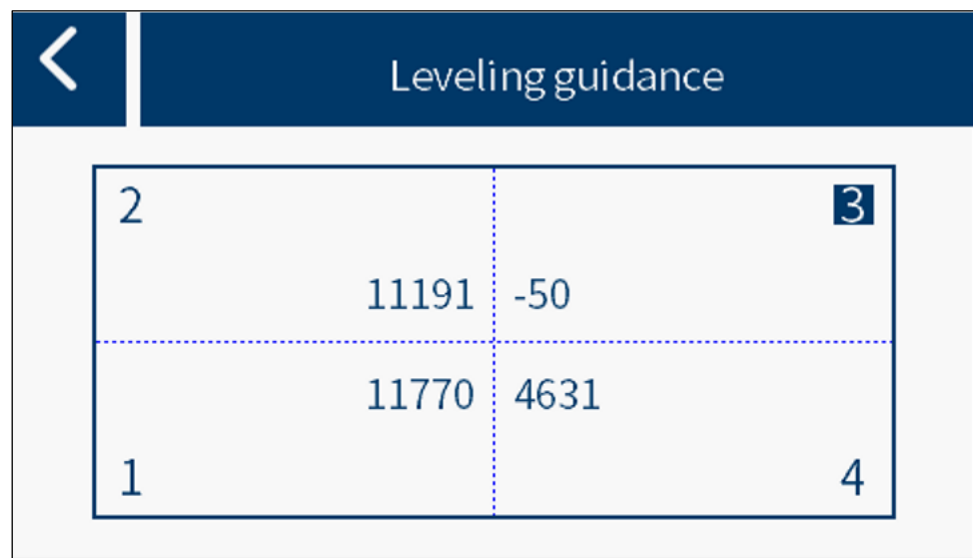

Figure 3-53 Local Display Leveling Guidance

Before using the leveling guidance, make sure you have set up your scale type to use 4 load cells and that you have completed the manual address process. When completing the calibration of the scale, make sure to complete the calibration with hysteresis.

- A bubble level should be used to initially level the PowerDeck platform before accessing the Leveling Guidance feature.

The Leveling Guidance graphic display represents a PowerDeck floor scale and assumes that the load cells are addressed as node 1 through 4 starting with the corner where the home-run cable exits and moving in a clockwise direction. The counts displayed in the center of the graphic indicate how many counts the current reading is above or below the stored factory value. The load cell with the largest negative count variance from the stored factory value is highlighted – cell 3 in the example above. This indicates that this load cell should be shimmed first. The display updates automatically as the count variances of each load cell change, so shims can be added or subtracted in an attempt to achieve an acceptable count variance. An

acceptable count variance is determined by the platform size, capacity and the number of increments as defined in the platform installation manual.

3.9.3. Error Message

Displays the error number, display message, detailed description and recommended action for any current errors detected by the IND360. When no errors are currently detected, this page will be blank. Refer to the Error Log for any past errors that have been cleared.

Error message			
No.	Alarm ID	Description	Action
1	4062	Overload	Remove load from scale
2	2011	Control network failure	Please. check the NW connection

Figure 3-54: Web Interface Error Message Screen

3.9.4. Update & Backup

Update the IND360 firmware and create a backup of the IND360 configuration from this screen.

3.9.4.1. Firmware download

The latest firmware files can always be downloaded from www.mt.com. After downloading the firmware file to your PC, press "Choose" and navigate to where the firmware file is saved on the PC. Once selected, the Filename, Hardware ID, Version and Match fields will automatically be filled. When the Match is successful, press "Update" to begin the firmware update and follow any onscreen prompts to complete. Please make sure not to power cycle the IND360 in the middle of a firmware update since this may cause an unrecoverable error.

Firmware	CHOOSE	UPDATE
Filename		
Hardware ID		
Version		
Match		

Figure 3-55: Web Interface Firmware Download Screen

3.9.4.2. Configuration

Allows the user either to create a new configuration backup or to load a previous configuration file in this section.

Configuration	CHOOSE	RESTORE	BACKUP
Filename	config (1).bck		
Hardware ID	77040023		
Version	1.00.0013.20220228		
Overwrite adjustment parameters	No		
Match			

Figure 3-56: Web Interface Configuration (Backup/Restore) Screen

3.9.4.2.1. Restore

To restore a previously saved configuration file, press "Choose" and navigate to the saved configuration file. Once selected, the Filename, Hardware ID, Version and Match fields will automatically be filled. When the Match is successful, press "Restore" to begin the restore configuration process and follow any onscreen prompts to complete.

- The restore function may overwrite the adjustment parameters, depending on the setting selected (in Figure 3-56) for **Overwrite adjustment parameters**. If **Yes** is selected, make sure to back up the parameter and to store the backup file carefully for future use.

3.9.4.2.2. Backup

To back up the current configuration of the IND360, press **BACKUP**. Name the configuration file and save it on the PC for future use. Refer to the Restore instructions above when ready to load this saved configuration in the future.

3.9.5. Application ID Generation

If an IND360 application was not selected at the time of order, a license to access an application can be generated in the field via the Application ID Generation feature.

License request code	GET
Application license type	Advanced base
Connectivity license type	None

Figure 3-57 Web Interface Application ID Generation Screen

First, select the desired application from the drop-down menu. Note that only applications not currently installed on the device will appear as options. Click "Get" to generate an Application ID. Contact your Mettler Toledo sales representative and provide them with the Application ID. Please note that there is an additional charge associated with adding applications to your IND360. Your salesperson will provide you with an Application License Activation Code. Paste that code into the IND360 webserver and click "Set". The new application will now be available on your device.

3.9.6. Update & Backup

Update the IND360 firmware and create a backup of the IND360 configuration from this screen.

3.9.7. Weight Simulator

The weight simulator allows the user to force a specific weight value that does not correspond to the weight currently on the scale. This should be used for testing purposes only. Once the weight simulator is enabled, type the desired weight value in the "weight input" and then click "Set". The entered weight value can be seen in the local IND360 display, the web interface and any connected automation system. The maximum value that can be tested is 3x the scale capacity. The minimum value is -3x the scale capacity. When the weight simulator is first enabled, the weight will immediately be forced to zero.

It is possible some values entered into the simulator are not perfectly reflected by IND360 at first. If this occurs (e.g. weight input = 100 kg, gross = 99.97 kg), simply perform a span adjustment using the simulated value. Once this adjustment is complete, it should not be needed again in the future.

- It is critical to confirm that any forced weight values will not cause damage or harm before enabling the weight simulator. Confirm you understand how your automation system will react to simulated weight values before proceeding.

Figure 3-58 Web Interface Weight Simulator Screen

3.9.8. Reset All Factory Defaults

Use the Reset All under the Maintenance branch to restore all setup parameters to factory defaults.

- The Reset All function resets all parameters in the indicator, except metrologically significant settings such as Scale type, capacity, etc.

When the Reset All screen is first accessed, a message displays that asks for confirmation that all setup parameters shall be reset to the factory default settings. To continue with the Reset All, press the Reset button. When the reset is successful, a message that reads "Setting Successful" displays. If the reset is unsuccessful, an error message that reads "Reset Failure" displays. If the

reset fails, try to initiate the reset again. If the reset continues to fail, contact a local METTLER TOLEDO representative for assistance.

4 Service and Maintenance

The IND360 indicator is designed to provide years of dependable operation. However, METTLER TOLEDO recommends that – as with any industrial equipment – the IND360 indicator and the connected scale system be serviced periodically. Timely, factory-specified maintenance and calibration by a METTLER TOLEDO service technician will ensure and document accurate and dependable performance to specifications.

4.1. Cleaning and General Maintenance

Clean the IND360 indicator's keypad and cover with a clean, soft cloth that has been dampened with a mild glass cleaner. Do not use any type of industrial solvent such as toluene or isopropanol (IPA) that could damage the indicator's finish. Do not spray cleaner directly on the indicator.



The IND360 Panel and Harsh versions are rugged stainless steel enclosed instruments; however, the front panel is a relatively thin covering over sensitive electronic switches and a lighted display. Care should be taken to avoid any punctures to this surface or vibrations or shocks to the instrument. If the front panel is punctured, immediately take appropriate steps to prevent dust and moisture from entering the unit until the indicator can be repaired.

	WARNING
	ONLY PERMIT QUALIFIED PERSONNEL TO SERVICE THE INDICATOR. EXERCISE CARE WHEN MAKING CHECKS, TESTS AND ADJUSTMENTS THAT MUST BE MADE WITH POWER ON. FAILING TO OBSERVE THESE PRECAUTIONS CAN RESULT IN BODILY HARM AND/OR PROPERTY DAMAGE.

4.2. Service

Only qualified personnel should perform installation, programming, and service to the IND360. Please contact a local METTLER TOLEDO representative for assistance.



METTLER TOLEDO recommends periodic preventative maintenance to the indicator and scale system to ensure reliability and to maximize service life. All measurement systems should be periodically calibrated and certified as required to meet production, industry and regulatory requirements. We can help you maintain uptime, compliance and quality system documentation with periodic maintenance and calibration services. Contact your local METTLER TOLEDO authorized service organization to discuss your requirements.

	 WARNING
	<p>DO NOT INSTALL, DISCONNECT OR PERFORM ANY SERVICE ON THIS EQUIPMENT BEFORE POWER HAS BEEN SWITCHED OFF AND THE AREA HAS BEEN SECURED AS NON-HAZARDOUS BY PERSONNEL AUTHORIZED TO DO SO BY THE RESPONSIBLE PERSON ON-SITE.</p>

4.3. Screen Saver

METTLER TOLEDO recommends the use of the automatic screen saver in order to maintain the clarity of the display. The IND360 screen saver is enabled within the setup menu at **Terminal > Display > Screensaver**.

4.4. Battery Replacement

	 WARNING
	<p>ONLY PERMIT QUALIFIED PERSONNEL TO PERFORM BATTERY REPLACEMENT UPDATES ON THE INDICATOR. PLEASE CONTACT A LOCAL METTLER TOLEDO REPRESENTATIVE FOR ASSISTANCE.</p>

A coin cell battery, model CR2032, is mounted on IND360 mainboard to supply power to RTC (Real Time Clock) module, used to provide Time and Date information. An alarm will be issued when this battery is low to indicate that it must be replaced. This battery should be disposed of according to local regulations. Once the battery is replaced the time and date must be reset.

When replacing the battery, power off the IND360 and then open the enclosure. Appendix A, Installation details how to open the enclosure. A socket on the mainboard, indicated in Figure 4-1, contains the battery.

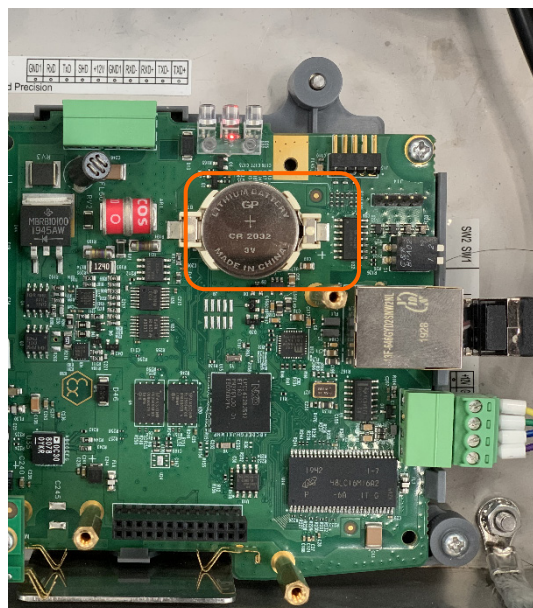

Figure 4-1: The Battery Socket on Mainboard

Pick the battery out and install a new one. Then follow the procedure to close the enclosure and power up the IND360. When the indicator starts, enter the Time and Date settings manually

either via the web interface or using the keypad and TFT display. The time and date settings page is shown in the web interface in Figure 4-2.

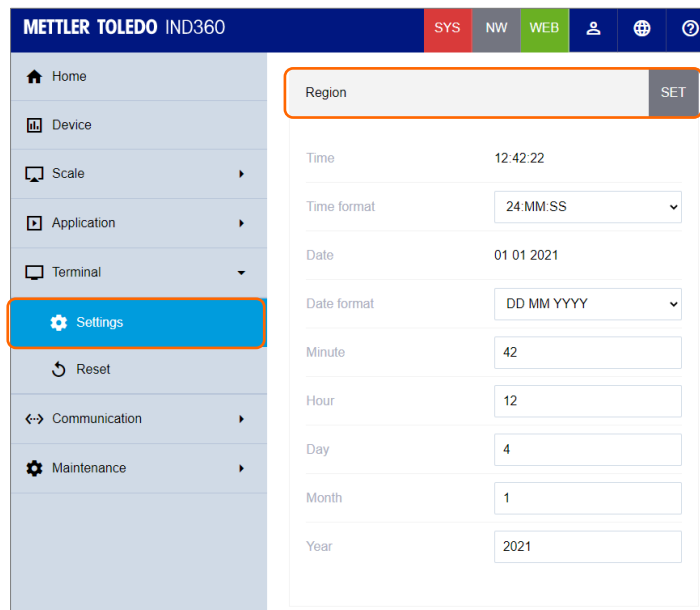

Figure 4-2: Setting Time and Date after Battery Replacement

4.5. Error Management

4.5.1. Smart5® Introduction

Smart5® is intended to harmonize events and alarms based on industry standards and common industry practice. These standards originated from the process control industry in chemistry, oil production and refining where there is a very high risk of explosion and bodily harm.

Some of the Smart5 alarms can also be observed at the PLC side; please refer to Table 4-2 for details.

4.5.1.1. Events versus Alarms

In the operation of a weighing device there are two conditions that must be monitored. First is an event. An event can be as simple as a weighing cycle or the indication of an out of tolerance condition; these are conditions that are significant enough for the system to indicate an error or inform the customer. Events are accumulated in a log file for predictive analytics, and may ultimately be escalated to a maintenance event that triggers an alarm.

The alarm is the ultimate error condition because it is used to communicate the condition to the customer immediately. An alarm condition is displayed, may be connected to a physical output, is logged in an alarm file, and is transmitted through the automation and/or IT interface to the customer.

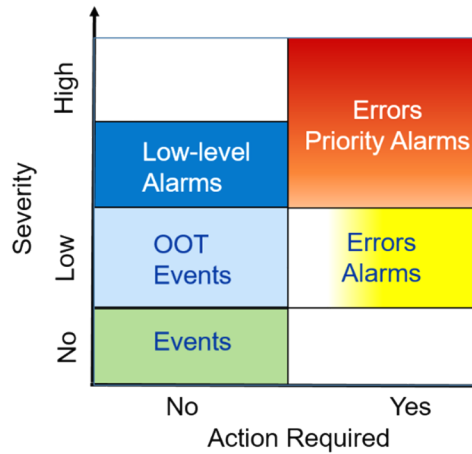







Figure 4-3: Severity and required action contrasts alarms and events

- Event** A state change, condition or Out of Tolerance (OOT); a low-level error condition that will be logged for use by predictive analytics. Events are non-critical to the operation of a weighing device and thus do not need corrective actions. Selected events which accumulate over a long period of time can lead to alarm conditions. For example 100,000 weighing transactions would drive a low level alarm signifying that a preventative maintenance, routine test or calibration must be undertaken.
- Alarm** Indicates an error as a result of an improper operator action, or an out of tolerance condition that must be logged in an alarm file and, depending on the criticality of the error, transmitted through the automation or IT interface. Depending on type, severe errors usually require a service intervention. In the worst case, at the customer’s discretion, the device would be disabled.

4.5.1.2. NAMUR Alarm / Alert Classification

Below is an adaptation of NE107 for weighing devices.

Table 4-1: Adapted NAMUR alarms

Graphical Indication	Rank	Type	Description	Result
	5	Catastrophic weighing error	Wrong weight / equipment failure	Alarm stops operation: Clearing the alarm will not reset the condition – the device must be repaired to eliminate the alarm
	4	Imminent failure	Wrong weight / equipment failure expected based on predictive algorithms and sensors like temperature, humidity.	Alarm indicates failure is imminent within a period of one week or more. The alarm can be reset but will recur each day until the cause is eliminated
	3	Out of specification	Wrong Operator Actions or device / application is operating out of specification	Alarm and log the event. Alarms are only generated / transmitted at the request of the customer
	2	Predictive Alarm	Routine test, Calibration or Preventative maintenance must be undertaken	Alarm and log the event. Alarms are only generated / transmitted at the request of the customer
	1	Normal Condition	Unit is operating correctly	No Action required

4.5.2. Error Log

The IND360 provides an Error Log which records the details of system errors. The log can save up to 500 records. Each error record includes:

- Date and time of the error.
- An error code generated with each error instance to give information about the cause of the error.
- A number in Hex represents how many times this error has been detected.
- An associated descriptive text for inclusion in reports or email alerts.

Each of these fields is separated by the pipe symbol "|", ASCII code 124(0x7C in HEX code). Figure 4-4 shows two sample records: The first indicates that the coin cell battery capacity is low, while the second shows that the network module has failed to initialize:

```
2021-02-31 21:59:01|00001004|0001|Battery low
2021-02-31 21:59:21|00002013|0001|Scale NW fail
```

Figure 4-4: Error Log Sample Records

This Log file can be exported only via the web interface, from the **Maintenance > Configure/View** screen. Click the EXPORT button and select the location on the PC to save the log file.

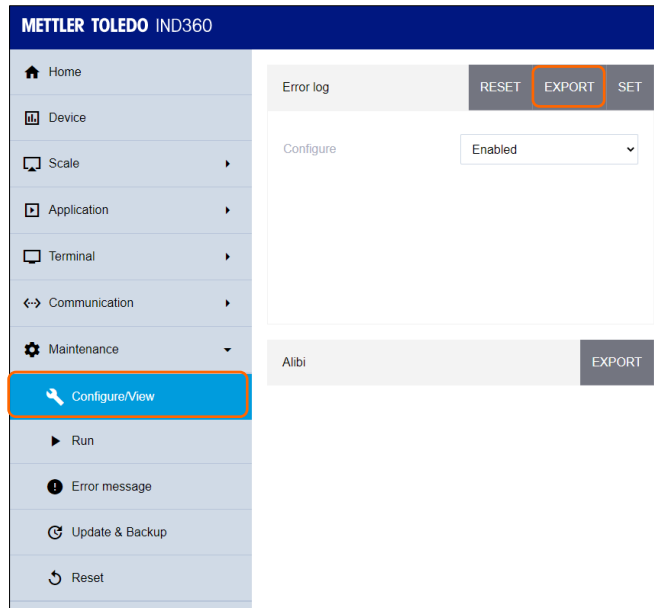

Figure 4-5: Export the Error Log File

4.5.3. Error Message

IND360 can display error messages on-screen when an abnormal condition occurs; this kind of message will differ on the OLED and 3.4" TFT screens. Refer to Table 4-2 for a list of error messages and recommended measures.

Table 4-2: IND360 Error Messages

No.	Message		Alarm Code	Namur Level	Error Log Record	SAI	LED Blink	Description	Recommended Measure
	OLED Display	TFT Display							
1	Option 1 fail	Option #1 PCB Failure	1001	5	Y	Y	SYS(Y)	Option board cannot work	Recycle power on IND360; or call MT Service
2	Option 2 fail	Option #2 PCB Failure	1002	5	Y	Y	SYS(Y)	Option board cannot work	Recycle power on IND360; or call MT Service
3	Internal NW fail	Internal NW Failure	1003	5	Y	N	SYS(Y)	Network module initialize fails	Recycle power on IND360; or call MT Service
4	Battery low	Battery Critically Low	1004	4	Y	Y	SYS(Y)	Coin cell battery power low	Replace battery
5	PLC NW fail	Control Network Failure	2011	5	Y	N	SYS(R)	The cyclic communication between IND360 and PLC has failed	Check the network connection or configuration
6	Scale missing	Scale Disconnected	2012	5	Y	Y	SYS(R)	The IND360 cannot find the Analog/Precision scale or load cell connection	Check the scale cable
7	Scale NW fail	Scale Network Failure	2013	5	Y	Y	SYS(R)	The IND360 cannot find the POWERCELL scale or load cell connection	Check the scale cable
8	LC fail #	Load Cell Missing #	2014	5	Y	Y	SYS(R)	The IND360 cannot find the POWERCELL load cell whose address is #	Check load cell # cable connection
9	Board info. err.	Board Parameter Error	3021	NA	Y	N		Some factory parameter error	Recycle power on IND360; Perform a Master Reset; or call MT Service
10	Calib. block err.	Cal Parameter Error	3022	NA	Y	N		Calibration parameter error,	Recycle power on IND360; Perform a Master Reset; or call MT Service
11	Scale block err.	Scale Parameter Error	3023	NA	Y	N		Scale menu parameter error	Recycle power on IND360; Perform a Master Reset; or call MT Service
12	Term. block err.	Terminal Parameter Err.	3024	NA	Y	N		Terminal menu parameter error	Recycle power on IND360; Perform a Master Reset; or call MT Service
13	App. block err.	App. Parameter Err.	3025	NA	Y	N		Application menu parameter error	Recycle power on IND360; Perform a Master Reset; or call MT Service
14	Com. block err.	Comm.Parameter Error	3026	NA	Y	N		Communication menu parameter error	Recycle power on IND360; Perform a Master Reset; or call MT Service
15	Maint.block err.	Statistic Parameter Err.	3027	NA	Y	N		Maintenance menu parameter error	Recycle power on IND360; Perform a Master Reset; or call MT Service
16	LC configure block error	Load Cell Parameter Err.	3028	NA	Y	N		POWERCELL load cell-related parameter error	Recycle power on IND360; Perform a Master Reset; or call MT Service

No.	Message		Alarm Code	Namur Level	Error Log Record	SAI	LED Blink	Description	Recommended Measure
	OLED Display	TFT Display							
17	LOG block err. reset?	Log Parameter Err.	3029	NA	Y	N		Log files-related parameter error	Recycle power on IND360; Perform a Master Reset; or call MT Service
18	ALW. block err. Reset?	Smart5 Parameter Err.	3030	NA	Y	N		AlertWeigh-related parameter error	Recycle power on IND360; Perform a Master Reset; or call MT Service
19	A/D fail	Analog Converter Fail	4041	5	Y	Y	SYS(R)	A-to-D converter cannot work normally, A-to-D processing task does not read AD data for more than 1s	Recycle power on IND360; or call MT Service
20	Zero failed motion	Zero Fail Motion	4042	NA	N	N		Zero is not allowed when the reading is not stable due to the load on scale changes	Make less change to the load on scale and zero again
21	Zero failed net mode	Zero Fail Net	4043	NA	N	N		Zero scale is not permitted when scale in net mode	Clear the Tare and zero again
22	Zero failed out of range	Zero Out of Range	4044	3	Y	N	SYS(R)	Zero scale is not permitted when load on scale is out of zero range	Remove load from scale or change the zero range and zero again
23	Zero failed zero disabled	Zero disabled	4045	NA	N	N		Zero scale is not permitted when Zero function is disabled in menu	Enable the function in menu and zero again
24	Tare failed motion	Tare Fail Motion	4046	NA	N	N		Tare is not permitted when the reading is not stable due to changing load on the scale	Make less change to the load on scale and tare again
25	Tare failed p.b. tare disabled	PB Tare Disabled	4047	NA	N	N		Tare is not permitted when Pushbutton Tare function is disabled in menu	Enable the function in menu and tare again
26	Tare failed prst. tare disabled	KB Tare Disabled	4048	NA	N	N		Tare is not permitted when Preset Tare function is disabled in menu	Enable the function in menu and tare again
27	Tare failed not rounded value	Tare Round Fail	4051	NA	N	N		Only a rounded value is allowed for Preset Tare	Use a rounded value for Preset Tare and tare again
28	Tare failed value too small	Tare Too Small	4052	NA	N	N		The scale is too large for this item to be tared	Change to a suitable scale; or change the increment
29	Tare failed zero not captured	Zero Init. Fail	4053	3	N	N		Tare is not permitted when Power-up Zero fails	Remove load from scale and recycle power on IND360
30	Tare failed over capacity	Tare out of Range	4054	NA	N	N		Tare is not permitted when load on scale exceeds capacity	Remove load from scale
31	Tare failed negative value	Tare Negative Fail	4055	NA	N	N		Tare is not permitted when the weight value is negative	Make the weigh value to be positive

No.	Message		Alarm Code	Namur Level	Error Log Record	SAI	LED Blink	Description	Recommended Measure
	OLED Display	TFT Display							
32	Tare failed tare disabled	Clear Tare Disabled	4058	NA	Y	N		Clear Tare function is disabled in menu	Enable the function in menu and clear again
33	Analog saturation	Analog Saturation Fail	4059	5	N	N		Weight far exceeds limit	Remove load from scale; or call MT Service
34	Factory zero not done	Factory Zero Fail	4060	NA	Y	N		Factory zero parameter lost	Call MT Service
35	Factory span not done	Factory Span Fail	4061	NA	N	N		Factory span parameter lost	Call MT Service
36	Scale overload	Overload	4062	5	Y	Y	SYS(R)	Too much load on the scale	Remove load from scale
37	Scale underload	Underload	4063	5	Y	Y	SYS(R)	The current load on scale is less than zero point	Please inspect scale for missing items or zero again
38	Scale overload – LFT	Trade Overload	4064	3	Y	Y	SYS(R)	Scale is too small for this item	Change to a suitable scale
39	Scale underload - LFT	Trade Underload	4065	3	Y	Y	SYS(R)	The current load on scale is less than zero point	Please inspect scale for missing items or zero again
40	LFT seal broken	Trade weight not valid	4066	3	Y	Y	SYS(R)	Scale not for commercial use	Scale not for commercial use
41	Sample too low	Sample size too small	4067	3	Y	Y	SYS(R)	The sample weight is too small	Choose a smaller scale for this item
42	Adjustment failure	Adjustment failure	4069	3	Y	Y	SYS(R)	Adjustment process has failed	Please attempt a new adjustment
43	MP adjustment failure	MP Adjustment Failure	4070	3	Y	Y	SYS(R)	The multi-point adjustment process has failed	Please attempt a new adjustment
44	Change log at 100%	Change Log at 100%	4071	3	Y	Y	SYS(R)	The change log file is full	Please export the log file
45	Change log at 90%	Change Log at 90%	4072	2	Y	Y	SYS(R)	The change log file is 90% full	Please export the log file
46	Scale high voltage	Load Cell Over voltage	5073	3	Y	Y	SYS(R)	The power supply voltage to POWERCELL scale or load cell is over limit	Please inspect load cables or call MT Service
47	Scale over current	Excessive Current	5074	3	Y	Y	SYS(R)	The power supply current to POWERCELL scale or load cell is over limit	Please inspect load cables or call MT Service
48	Cell enclosure breach	Cell enclosure is broken	5075	4	Y	Y	SYS(R)	The POWERCELL load cell enclosure breaks	Please inspect load cell and call MT Service
49	LC out of range - Temperature	Cell temperature exceeds limits	5076	3	Y	Y	SYS(R)	Ambient temperature is too high for accurate results	Please adjust the ambient temperature or call MT Service

No.	Message		Alarm Code	Namur Level	Error Log Record	SAI	LED Blink	Description	Recommended Measure
	OLED Display	TFT Display							
50	LC out of op range - Temperature	Load cell temperature exceeds limits	5077	3	Y	Y	SYS(R)	Ambient temperature is too high for normal operation	Please adjust the ambient temperature or call MT Service
51	Cell overload x	Cell is overloaded #xx	5078	3	Y	Y	SYS(R)	The load on POWERCELL load cell # is higher than limit	Please inspect the load on load cell # or call MT Service
52	Cell Overload x	Cell is overloaded #xx	5079	5	Y	Y	SYS(R)	The load on POWERCELL load cell # is higher than operation limit	Please inspect the load on load cell # or call MT Service
53	Wrong cell mix	Foreign Load Cell detected	5080	5	Y	Y	SYS(R)	Different POWERCELL load cell models used in the scale	Please inspect the load cell model to avoid mix use of different load cells
54	Cell underload x	Cell is underload #xx	5081	3	Y	N	SYS(R)	The load on POWERCELL load cell # is lower than operation limit	Please inspect the load on load cell # or call MT Service
55	Pairing failed.	Pairing failed.	5083	5	Y	N	SYS(R)	Shift adjust by pair fails	Perform the shift adjust again or call MT Service
56	FACT Failed. Consecutive Attempts	FACT 3 Consecutive Failed Attempts	5084	3	Y	N	SYS(R)	FACT (Fully Automatic Calibration Technology) function failed for 3 Consecutive attempts	Please inspect the connected weigh module or call MT Service

4.6. Alibi Log

The Alibi log stores transaction information in a preset format that is not changeable. The Alibi log can be enabled or disabled in setup at **Application > Alibi Memory**.

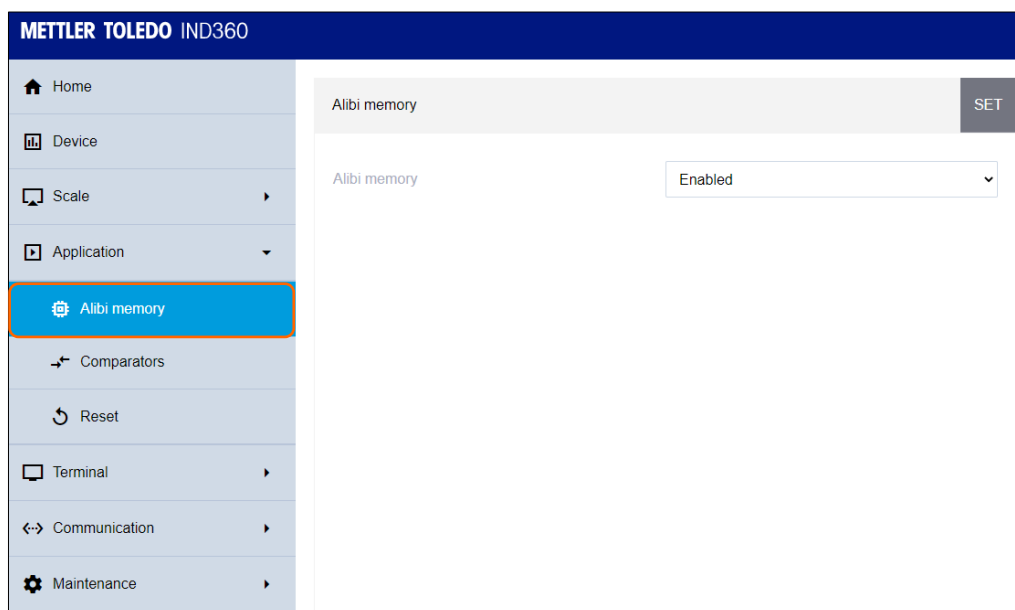

Figure 4-6: Alibi Memory Menu

4.6.1. Log File Structure

The alibi log operates by storing up to 27,000 alibi records in internal memory triggered by a print operation. When the log file is full, it starts to roll over and overwrite the oldest records. Each record in the Alibi Memory file includes:

Table 4-3: Alibi Log File Structure

Name	Description
Transaction Counter	This value is a unique numeric field that identifies the transaction
Separator	Comma
Timestamp	Date and time of Alibi record occurrence
Separator	Comma
Gross Weight	Recorded gross weight
Separator	Comma
Tare Weight	Recorded tare weight
Separator	Comma
Unit	Weighing unit
Separator	Comma
Tare mode	T: tare captured by scale; PT: preset tare

Users can export all records in the file AlibiData.csv via the Web interface at **Maintenance > Configure/View**.



Figure 4-7: Alibi Log Export Menu

	A	B	C	D	E	F
1	Transaction	Time	Gross	Tare	Unit	Tare Mode
2	1	6/25/2021 8:47	5.79	0	lb	T
3	2	6/25/2021 8:49	4.42	0	lb	T
4	3	6/25/2021 8:49	2.94	0	lb	T
5	4	6/25/2021 8:49	3.97	2.74	lb	T

Figure 4-8: Alibi Log Example

4.7. Maintenance Log

The Maintenance Log tracks service operations that an Operator or Service Technician performs on the equipment. MT Service and Validation Agencies or those who audit for them will use this log. Users can view up to 2,500 records. When the records reach 100%, the newest one will replace the oldest one. The event can be triggered by either a remote or local operation. Users could export all records by the web interface at **Maintenance > Configure/View**. A Master Reset clears the log. Users also can clear the log by selecting Reset under the log menu, or by disabling the log.



Figure 4-9: Maintenance Log Export Menu

4.7.1. Log File Structure

This log is an internal file which will be used to generate the maint.csv file. So this file is not visible for users. For IND360, the log file record structure as follows:

Table 4-4: Log File Structure

Name		Description
Timestamp		Date & time of Change
Separator		Comma
Event ID		Event Identification Code
Separator		Comma
Status		ASCII Numeric Status or Text that is unique for each logged event.

Table 4-5: Events and Status Codes

Event	Description	Status Code(s)
2	Zero calibration performed	FAILURE, SUCCESS, motion
3	Span calibration performed	FAILURE, SUCCESS, motion
4	CALFree calibration performed	FAILURE, SUCCESS
5	POWERCELL cell Shift Adjust	FAILURE, SUCCESS
6	POWERCELL cell Address	FAILURE, SUCCESS
8	Log file exported	Maintenance log, Change log, Alibi log or Error log
10	Metrology switch / electronic seal broken	SUCCESS
14	Run Flat Operation Auto Start	SUCCESS
18	Maintenance Log initialized	SUCCESS
19	Calibration values manually edited	SUCCESS
20	Shift edit manually	SUCCESS
21	Set date or time	SUCCESS
41	POWERCELL load cell enclosure break	
42	POWERCELL load cell replace	Load cell S/N

	A	B	C
1	Timestamp	Event	Status
2	2021/1/1 1:36	8	Error log
3	2021/1/1 1:41	8	Error log
4	2021/1/1 1:45	8	Error log
5	2021/2/31 23:59	8	Error log
6	2021/2/31 23:59	8	Error log
7	2021/2/31 23:59	8	Change log

Figure 4-10: Maintenance Log Example

4.8. Change Log

The Change Log is the configuration history log file that contains a complete record of the changes made to Data Center Setup, calibration fields, and to the standard Tables. It provides an audit trail of major data changes in the IND360 since its initial installation or most recent file reset. This historical record is a requirement in the pharmaceutical and food industries, where companies must prove their compliance with governmental regulations.

Users can view up to 2,500 records. When the records reach 100%, the newest one will replace the oldest one. An event can be triggered by either a remote or local operation. Users may export all records by the web interface at **Maintenance > Configure/View**. Master Reset clears the log. Users also may clear the log by selecting Reset under the log menu, or by disabling the log.

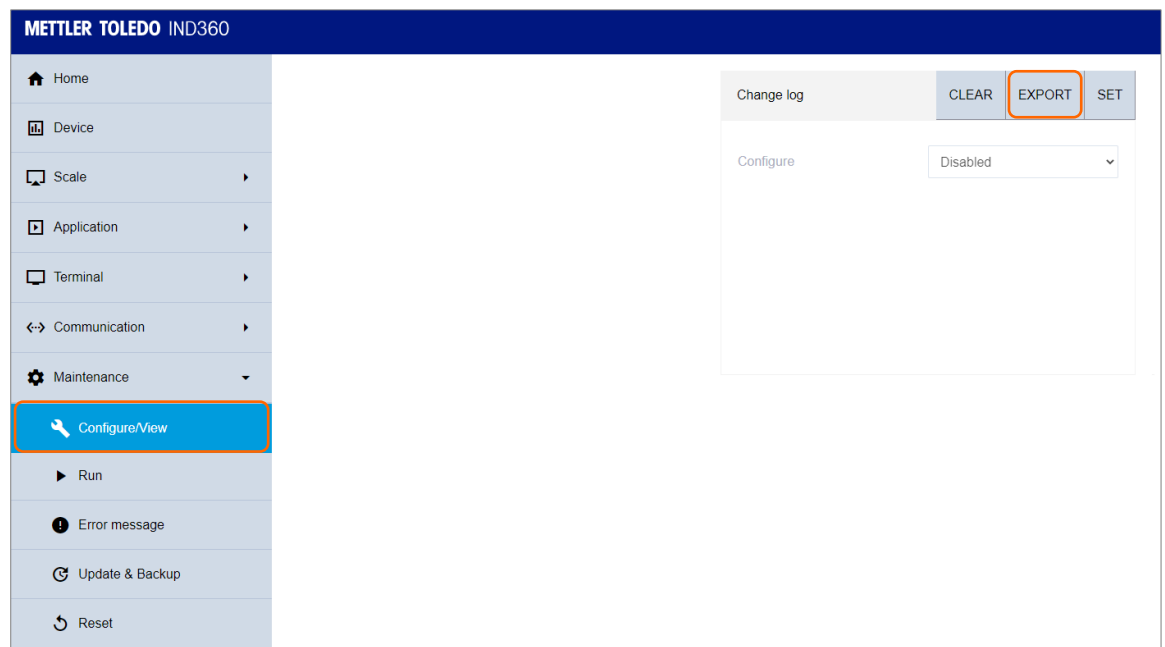

Figure 4-11: Change Log Export Menu

4.8.1. Log File Structure

This log is an internal file which will be used to generate the Change.csv file; it is not visible to users. It contains intentional changes to system configuration parameters. These include changes to setup, calibration and so on, together with new values. A Master Reset destroys all log files and table contents.

For IND360, the log file record structure as follows:

Table 4-6: Log File Structure

Name	Description
Timestamp	Date & time
Separator	Comma
Data ID	The ID represents which parameter has been changed, Vxxxxx for parameter identifier(such as V10121) or Bxxxxx for block reset(such as B00001)
Separator	Comma
Current Value	The current value of changed parameter

Table 4-7: Data ID

Data ID	Description
10121	Scale Increment index
10302	Approval Type
10303	Local Geo
10311	Blank of over capacity
10312	Primary Unit
10316	Power up Zero Range +
10317	Power up Zero Range -
10319	Auto Zero Range
10320	Blank of Under Zero
10321	PushButton Zero
10322	PushButton Zero Range +
10323	PushButton Zero Range -
10324	Auto Tare
10325	Auto Tare Threshold
10326	Auto Tare Reset Threshold
10328	Auto Clear
10329	Auto Clear Threshold
10331	Push Button Tare
10332	Preset Tare
10333	Power up Zero Mode
10334	Power up Tare Mode
10335	LowPass Filter Level
10336	LowPass Filter Environment
10337	Stability Filter
10338	Motion Range
10339	Motion Time
10340	Motion Wait Timeout
10369	Low Pass Filter (POWERCELL)
10372	Analog load cell type
10373	Analog load cell number

Data ID	Description
10375	Customer overload
10376	Customer underload
10381	Customer under/overload enable/disable
10401	Screen Save
10402	Language
10403	User Manage
10404	Password
10405	Disable Keypad
10501	Active Load cell number
10502	Dummy Load cell number
10503	Shift Mode
10504	Shift Adjustment Factor Array
10505	Load cell Type Array
10506	Current Load cell Zero Counts Array
10507	Load cell Software Version Array
10508	RunFlat Config
11101	Comparator 1 Source
11102	Comparator 1 Operation
11103	Comparator 1 Latch
11104	Comparator 1 Unit
11105	Comparator 1 Target
11106	Comparator 1 Target 2
11107	Comparator 1 Description
11108~11114	Comparator 2 Source ~ Description
11115~11121	Comparator 3 Source ~ Description
11122~11127	Comparator 4 Source ~ Description
11129~11134	Comparator 5 Source ~ Description
11136~11141	Comparator 6 Source ~ Description
11143~11149	Comparator 7 Source ~ Description
11150~11156	Comparator 8 Source ~ Description
11157~11163	Comparator 9 Source ~ Description
11164~11170	Comparator 10 Source ~ Description
11171~11177	Comparator 11 Source ~ Description
11178~11184	Comparator 12 Source ~ Description
11185~11191	Comparator 13 Source ~ Description
11192~11198	Comparator 14 Source ~ Description
11099~11105	Comparator 15 Source ~ Description
11201	Input 1 Assignment
11202	Input 2 Assignment
11203	Input 3 Assignment
11204	Input 4 Assignment

Data ID	Description
11205	Input 5 Assignment
11206	Input 1 TriggerMode
11207	Input 2 TriggerMode
11208	Input 3 TriggerMode
11209	Input 4 TriggerMode
11210	Input 5 TriggerMode
11301	Output 1 Assignment
11302	Output 2 Assignment
11303	Output 3 Assignment
11304	Output 4 Assignment
11305	Output 5 Assignment
11306	Output 6 Assignment
11307	Output 7 Assignment
11308	Output 8 Assignment
11401	Industrial Ethernet IP Address
11402	Industrial Ethernet Mask
11403	Industrial Ethernet Gateway
11405	SAI Data Format
11406	PROFIBUS Node Address
11407	Byte Order
11408	Fieldbus Ethernet DHCP
11409	Fieldbus Type
11410	Station Name (PROFINET)
11424	Modbus Baud Rate
11425	Modbus Data bits
11426	Modbus Parity
11427	Modbus Flow Control
11428	Modbus Byte Order
11429	Modbus Node Address
11430	Analog Output Zero Counts
11431	Analog Output Full Counts
11432	Analog Output Zero Value
11433	Analog Output Full Value
11434	Analog Output Source
11435	Analog Output Type
11436	Service Ethernet IP Address
11437	Service Ethernet Mask
11438	Service Ethernet Gateway
11439	Service Ethernet DHCP
11440	E-Print Port
11441	PC-Connection Port

Data ID	Description
11442	Modbus Terminator
11457	4140 RS232 Baudrate
11458	4140 RS232 Bit Number
11459	4140 RS232 Parity
11460	4140 RS232 Stop Bit
11461	4140 RS232 Flow Control
11462	4140 RS4xx Baudrate
11463	4140 RS4xx Bit Number
11464	4140 RS4xx Parity
11465	4140 RS4xx Stop Bit
11466	4140 RS4xx Flow Control
11467	4140 RS4xx Protocol Type
11469	Continuous Output RS232 Checksum
11470	Continuous Output RS4xx Checksum
11471	Continuous Output RS232 Mode
11472	Continuous Output RS4xx Mode
11474	OPC UA port
11475	Json

	A	B	C
1	Timestamp	DataID	CurrentValue
2	2021/1/1 0:01	V10305	6000
3	2021/1/1 0:01	V10306	1
4	2021/1/1 0:01	V10333	0
5	2021/1/1 0:01	V10369	1

Figure 4-12: Change Log Example

4.9. Diagnostic Information

The IND360 provides quick access to system identification and system performance information that service providers will find helpful in diagnostic and troubleshooting efforts. The following sections provide guidance on how to access this information.

4.9.1. Information Recall

Select the INFORMATION RECALL  icon on menu or the web interface at Device to access the recall information. The IND360 Model, SN, Software version, Metrology and Option relates info,

at the right side is the Service Ethernet (the web interface RJ45 port) related info, example shown in Figure 4-13.

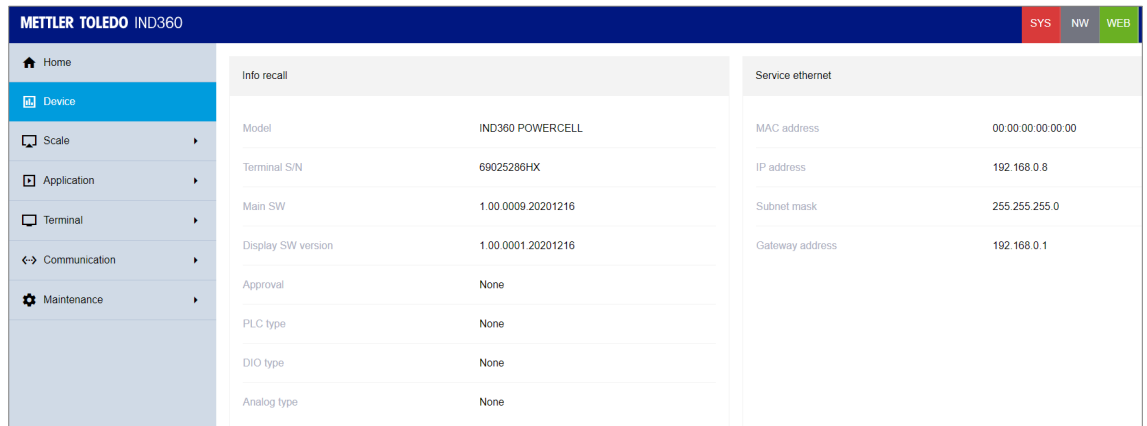

Figure 4-13: Information Recall View

4.1. Problem Diagnosis and Troubleshooting

4.1.1. Troubleshooting

The troubleshooting activities described here are intended to assist a user in identifying whether a problem is in the IND360 indicator or has an external cause.

4.1.1.1. Diagnostic LEDs

3 diagnostic LEDs on the mainboard of IND360 are externally visible in the Panel and DIN enclosure types, but not for Harsh Environment version. The Harsh version's enclosure must be opened to inspect the LEDs. When power is first applied to the IND360, the LEDs will indicate that the network is missing until a successful connection is achieved.

Table 4-8: Diagnostic LEDs

LED Indication	Description
SYS	SYS LED remains solid if everything is OK, but blinks for any abnormal states, as indicated in Table 4-2
NW1	These 2 LEDs are used to show the status of Automation bus. They have different states depending on the Automation bus profiles: for example, if PLC communication is OK, both LEDs will remain on for PROFINET, but OFF for Ethernet/IP
NW2	

There is "SYS" mark on the overlay of the DIN or Panel versions; in the Harsh version the System LED is the rightmost one from the view of an operator in front of the IND360 Harsh version.

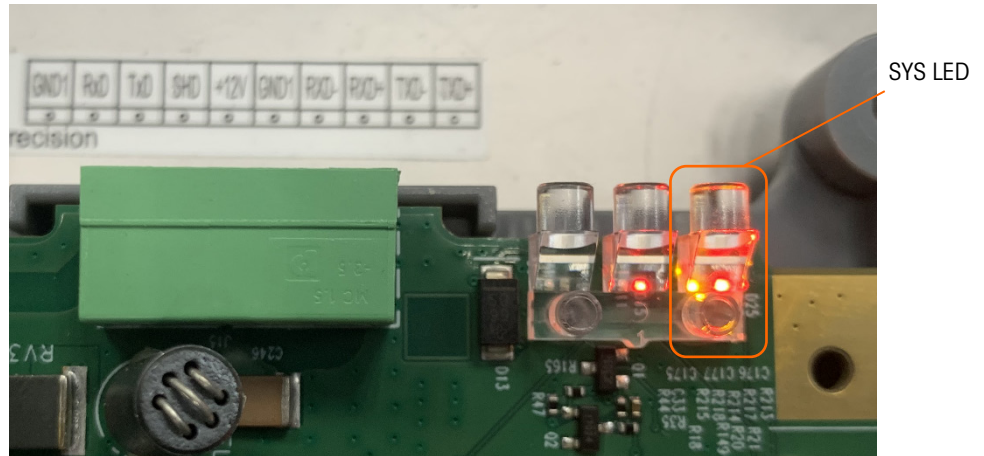

Figure 4-14: System LED Position

4.1.1.2. NW1 and NW2 LEDs

The NW1 and NW2 LEDs will behave in different ways, depending on the automation interface in use. Please refer to the following tables.

Table 4-9: NW1 and NW2 LEDs Status, PROFINET

LED	Signal	Status Description
NW1	BF (Bus Failure)	Off No error
		Flashing Red (2 Hz) No data exchange
		Solid Red No configuration; or low speed physical link; or no physical link
NW2	SF (System Failure)	Off No error
		Flashing Red (1 Hz, 3 s) DCP signal service is initiated via the bus.
		Solid Red Watchdog timeout; channel, generic or extended diagnosis present; system error

Table 4-10: NW1 and NW2 LEDs Status, EtherNet/IP

LED	Signal	Status Description
NW1	NS (Network Status)	Solid Green Connected – an IP address is configured, at least one CIP connection (any transport class) is established, and an Exclusive Owner connection has not timed out.
		Flashing Green (1 Hz) No connections – an IP address is configured, but no CIP connections are established, and an Exclusive Owner connection has not timed out.
		Flashing Green/Red/Off Self-test – the device is performing its power-up testing.
		Flashing Red (1 Hz) Connection timeout – an IP address is configured, and an Exclusive Owner connection for which this device is the target has timed out. The network status indicator returns to steady green only when all timed out Exclusive Owner connections are reestablished.
		Solid Red Duplicate IP – the device has detected that its IP address is already in use.

LED	Signal	Status Description	
		Off	Not powered, no IP address – the device does not have an IP address (or is powered off).
NW2	MS (Module Status)	Solid Green	Device operational – the device is operating correctly.
		Flashing Green (1 Hz)	Standby – the device has not been configured
		Flashing Green/Red/Green	Self-test – the device is performing its power-up testing. The module status indicator test sequence occurs before the network status indicator test sequence, according to the following sequence: <ul style="list-style-type: none"> • Network status LED off. • Module status LED turns green for approximately 250 ms, turns red for approximately 250 ms, and again turns green (and holds that state until the power-up test has completed). Network status LED turns green for approximately 250 ms, turns red for approximately 250 ms, and then turns off (and holds that state until the power-up test has completed).
		Flashing Red (1 Hz)	Major recoverable fault – the device has detected a major recoverable fault. E.g., an incorrect or inconsistent configuration can be considered a major recoverable fault.
		Solid Red	Major unrecoverable fault – the device has detected a major unrecoverable fault.
		Off	No power – the device is powered off.

Table 4-11: NW1 and NW2 LEDs Status, PROFIBUS DP

LED	Signal	Status Description
NW1	Not used	
NW2	Solid Green	RUN, cyclic communication
	Flashing Green (2 Hz)	Master is in CLEAR state.
	Flashing Red Flashing (1 Hz)	The device is not configured.
	Flashing Red (2 Hz)	STOP, no communication, connection error
	Solid Red	Wrong configuration at PROFIBUS DP Slave
	Off	Device is not switched on or supply voltage is missing.

Table 4-12: NW1 and NW2 LEDs Status as per Modbus RTU

LED	Signal	Status Description
NW1	Green (Send/Receive status indication)	Solid Green Default
		Flashing Green Data exchange: <ul style="list-style-type: none"> • When starting to receive data, turn LED ON • When data reception is complete, turn LED ON • When starting to send the data, turn LED OFF • When data transmission is complete, turn LED ON
NW2	Red	Off Default

LED	Signal	Status Description
		Solid Red <ul style="list-style-type: none"> When invalid data is received (invalid command, register address or length), turn LED ON When correct data is received, turn LED OFF

Table 4-13: NW1 and NW2 LEDs Status, EtherCAT

LED	Signal	Status Description	
NW1	ERR	Off	No error
		Flashing Red (2.5 Hz)	Invalid configuration
		Single Flash Red	Local error
		Double Flash Red	Application watchdog timeout
NW2	RUN	Off	Initial state
		Flashing Green (2.5 Hz)	The device is in PRE-OPERATIONAL state.
		Single Flash Green	device is in SAFE-OPERATIONAL state.
		Solid Green	The device is in the OPERATIONAL state.

Table 4-14: NW1 and NW2 LEDs Status, CC-Link IE Field Basic

LED	Signal	Status Description	
NW1	ERR	Solid Red	Communication error.
		Tripple Flash Red	DPM watchdog has expired.
		Off	Station is connected.
NW2	RUN	Solid Green	Station in operation and cyclic transmission in progress
		Flashing Green (2.5 Hz)	Station in operation and cyclic transmission stopped.
		Flashing Green (10 Hz)	Station not configured.
		Off	Station is disconnected.

Table 4-15: NW1 and NW2 LEDs Status, Modbus TCP

LED	Signal	Status Description	
NW1	ERR	Off	No communication error
		Flashing Red (2 Hz)	System error
		Solid Red	Communication error active
NW2	RUN	Solid Green	Connected
		Flashing Green (1 Hz)	Ready, not configured yet
		Flashing Green (5 Hz)	Waiting for Communication
		Off	Not Ready

4.1.1.3.

RJ45 LEDs

There are at most three RJ45 connectors in IND360 – the RJ45 port at the top of DIN weighing indicator is for the web interface connectivity, while the other 2 are for Industrial Ethernet (PROFINET, EtherNet/IP, or other) connectivity. Each connector has 2 embedded status LEDs: Active and Speed.

Table 4-16: RJ45 LEDs

LED Indication	Color	Description
Active	Yellow	Flickering: Communication present
Speed	Green	Solid: 100Mb/s OFF: 10Mb/s



Figure 4-15: RJ45 LEDs

4.1.2. Built-in Diagnostic Tests

The IND360 provides several internal diagnostic tests that are accessible in setup mode. Press the SETUP softkey  to view the setup menu tree. Use the DOWN navigation key to scroll down the menu tree to Maintenance. Press the RIGHT navigation key to expand the menu tree selections for Maintenance. Scroll down and expand Run. Scroll down and expand Diagnostics. Available diagnostic setup screens include:

4.1.2.1. Load Cell Output

This parameter displays the current load cell output (active weight) in internal measurement intervals (counts). In a properly functioning system these counts will increase. In an analog strain gauge system they will decrease (when weight is applied) when the signal wires are improperly connected.

View the Load Cell Output at the **Maintenance > Run** menu via the web interface screen shown in Figure 4-16.

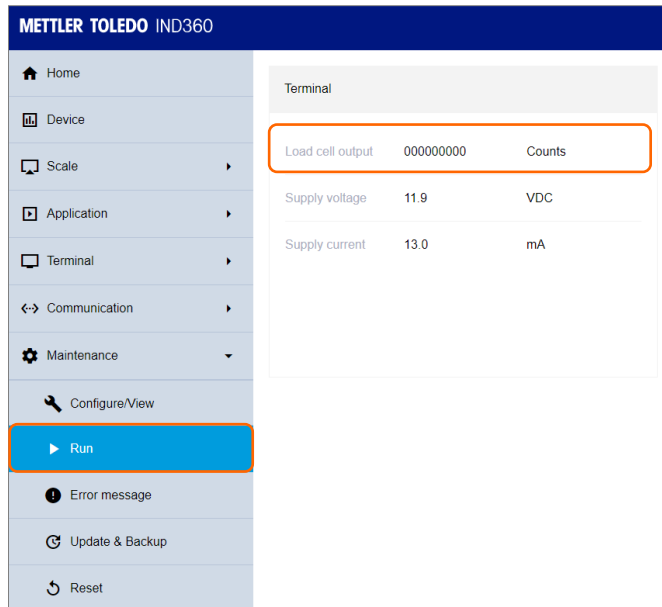

Figure 4-16: Load Cell Output Menu

4.1.2.2. Adjustment Values

This screen displays the current adjustment values for the scale. When these values are recorded after a scale adjustment, and the Main PCB is replaced in the future, the adjustment values can be entered here to transfer the previous calibration to the new Main PCB. View the Load Cell Output at the **Maintenance > Run** menu via the web interface screen shown in Figure 4-17

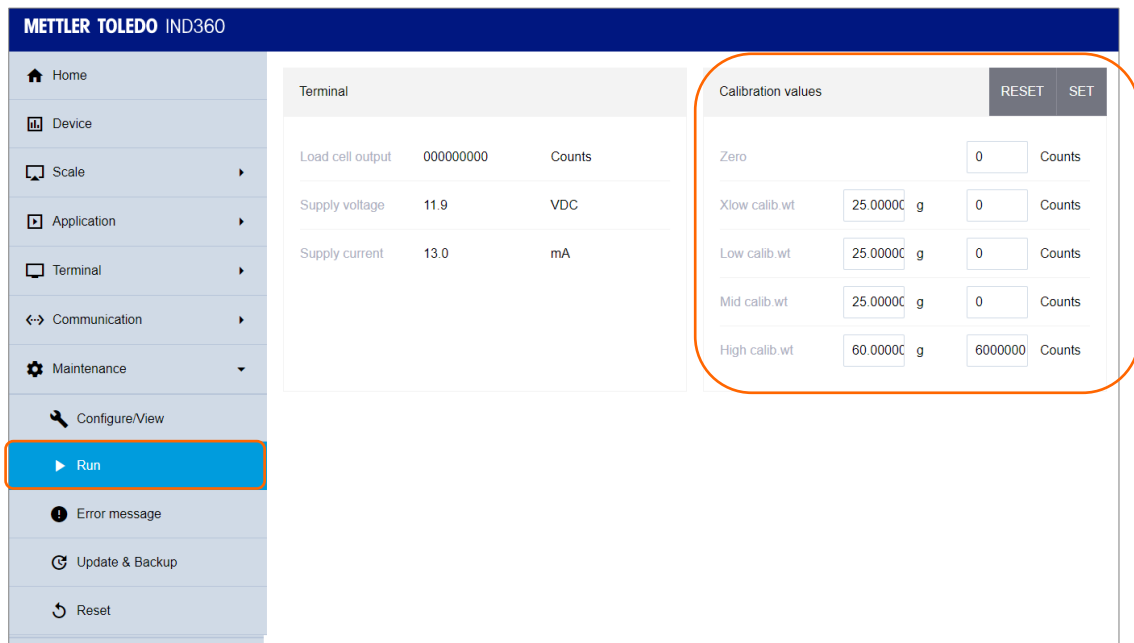

Figure 4-17: Adjustment Values Menu

4.1.2.3. Shift Values & POWERCELL Load Cell Info

This screen displays the shift adjustment values and load cell information for POWERCELL load cell scales. The shift adjust values can be both viewed and edited. Note that transcription errors of these shift values will lead to unstable performance.

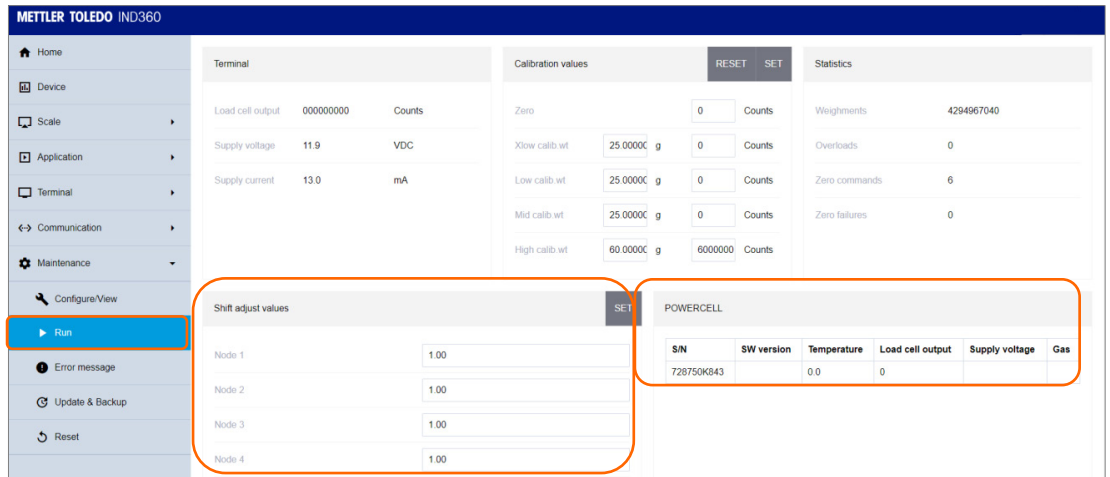

Figure 4-18: Shift Values and POWERCELL Load Cell Information Menu

4.1.2.4. Statistics

This screen displays statistical information for the scale such as the total number of weighments, the number of scale overloads, the peak weight weighed on the scale, total number of zero commands and failed zero commands. These are very helpful when diagnosing scale problems.

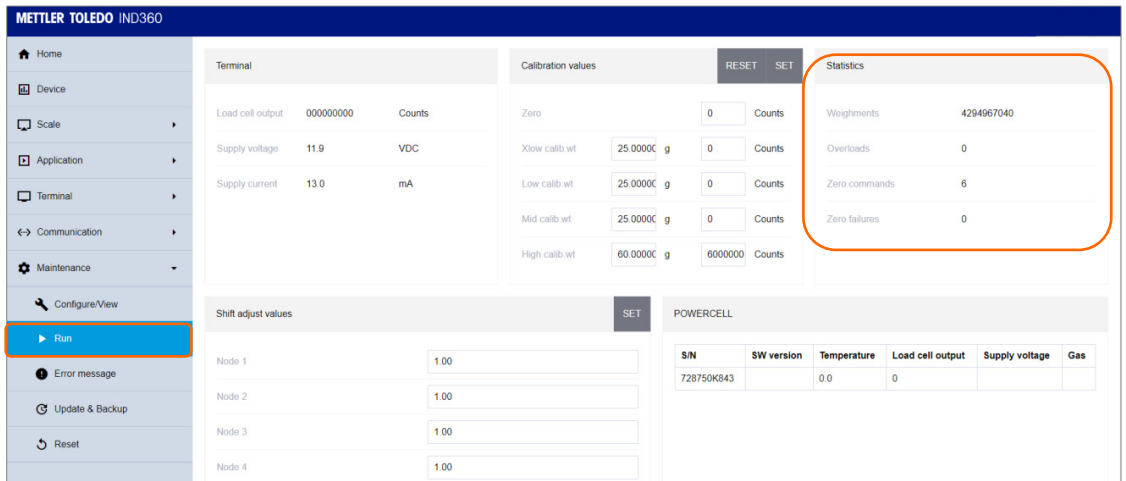

Figure 4-19: Statistics Menu

4.2. Master Reset

A master reset function is provided to allow reset of all IND360 indicator settings to the factory default settings (refer to Appendix B, **Default Settings**).

The master reset typically is performed under these circumstances:

- When a software configuration problem arises that cannot be resolved without starting from the factory default settings.
 - When user security is enabled to protect unauthorized access or use, and the "admin" account password is lost.
 - After a firmware upgrade is performed (recommended).
- **NOTE:** Ensure that indicator configuration and adjustment values are backed up before performing a Master Reset. This data can be reloaded into the indicator after the Master Reset is complete.

4.2.1. To initiate a master reset

1. Remove AC or DC power from the indicator.
2. Place both switches SW2 in the ON position, as shown in Figure 4-20.



Figure 4-20: Metrology Switch Location

- When a reset of calibration data is also required, set SW1 to OFF. The position of SW1 determines whether adjustment significant data (scale, calibration) is reset when a master reset is performed. If SW1 is set to ON, metrologically significant data will not be affected by the master reset.
3. Apply AC or DC power. During the power up sequence, the display will indicate a warning message "Master reset (W&M)?" or "Master reset?" depending on whether SW1 is set to OFF (up, in Figure 4-20) or ON.

Table 4-17: SW1 and SW2 Status in Master Reset

SW1 Position	SW2 Position	Message on Display	Description
ON	ON	"Master reset"	Resets all parameters except the metrologically significant data during the next power up sequence.
OFF	ON	"Master reset (W&M)"	Resets all parameters including the metrologically significant data during the next power up sequence.

4. Press ENTER to perform a master reset and return all settings to factory defaults. This initiates a power cycle and returns the indicator to the home screen.
 - To cancel and exit without performing a master reset, press Zero key. Remove power. Return SW1 and SW2 to their original OFF positions. Reapply AC or DC power.

5.1.2. PCBA Kit, 4-20mA, IND360 HARSH

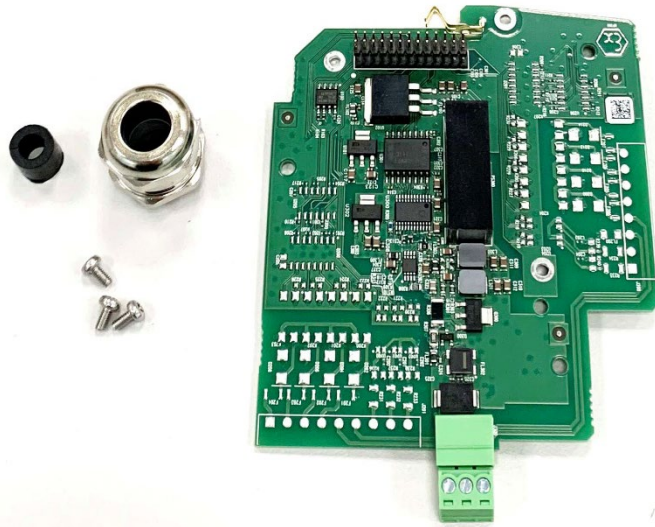

Part Description	Part No.
4-20mA/0~10V analog output PCBA kit for IND360 Harsh version	30601150

5.1.3. PCBA Kit, 4-20mA, 3I/4O IND360, DIN/PANEL

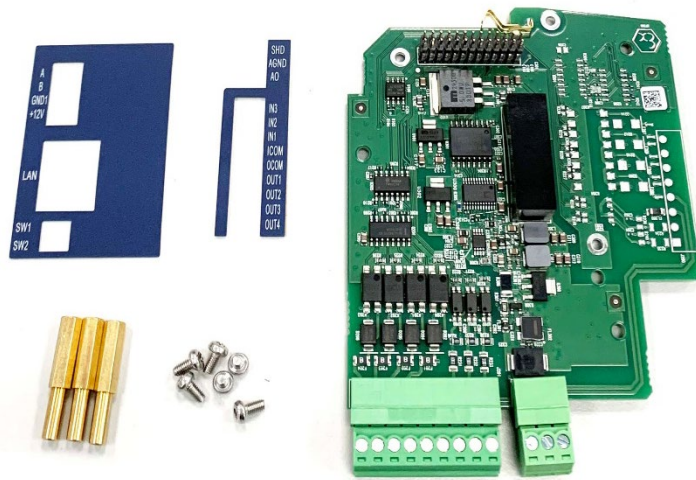

Part Description	Part No.
PCBA kit of 4-20mA/0~10V analog output, 3 discrete inputs, 4 discrete outputs (solid state) for IND360 DIN and Panel mount versions, including enclosure opening tool	30601151

5.1.6. PCBA Kit, 5I/8O, IND360 HARSH



Part Description	Part No.
PCBA kit of 5 discrete inputs, 8 discrete outputs (solid state) for IND360 Harsh version	30601154

5.1.7. PCBA Kit ext. memory 4In/4Out IND360 D/P

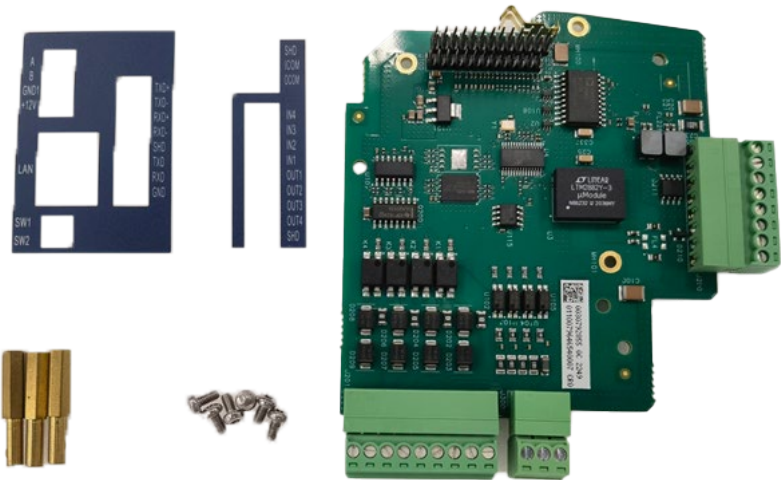

Part Description	Part No.
PCBA kit of 4 discrete inputs, 4 discrete outputs (solid state) and extended alibi memory for dynamic applications. This kit fits IND360 DIN and Panel mount versions.	30832358

5.1.8. PCBA Kit ext. memory 4In/4Out IND360 H

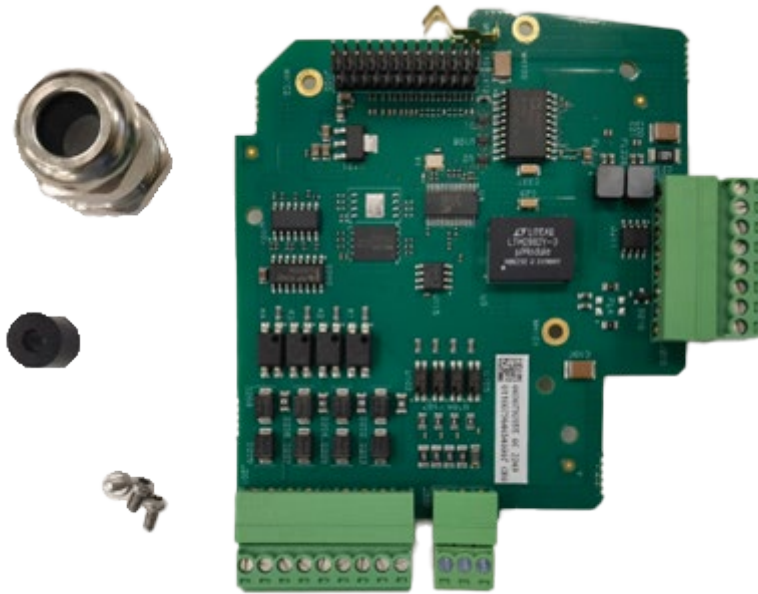

Part Description	Part No.
PCBA kit of 4 discrete inputs, 4 discrete outputs (solid state) and extended alibi memory for dynamic applications. This kit fits IND360 Harsh version.	30832359

5.1.9. PCBA Kit, Modbus RTU, IND360, DIN/PANEL

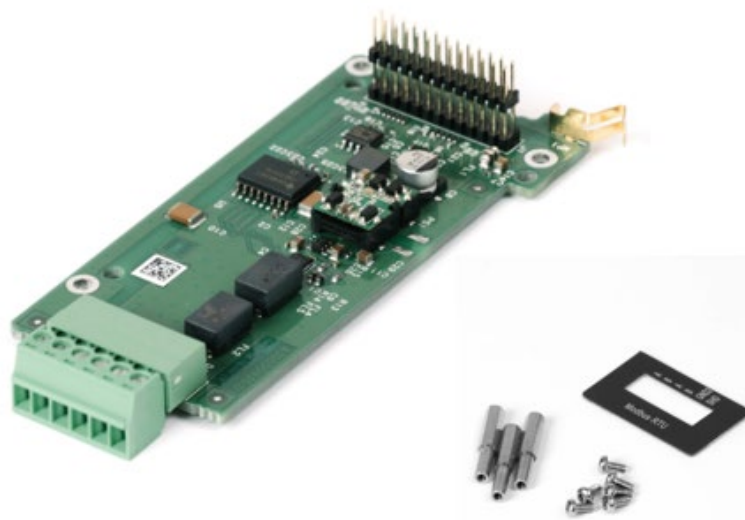

Part Description	Part No.
PCBA kit of Modbus RTU connection for IND360 DIN and Panel mount versions, including enclosure opening tool	30601159

5.1.10. PCBA Kit, Modbus RTU, IND360 HARSH



Part Description	Part No.
PCBA kit of Modbus RTU connection for IND360 Harsh version	30601160

5.1.11. PCBA Kit, Profibus DP IND360, DIN/PANEL

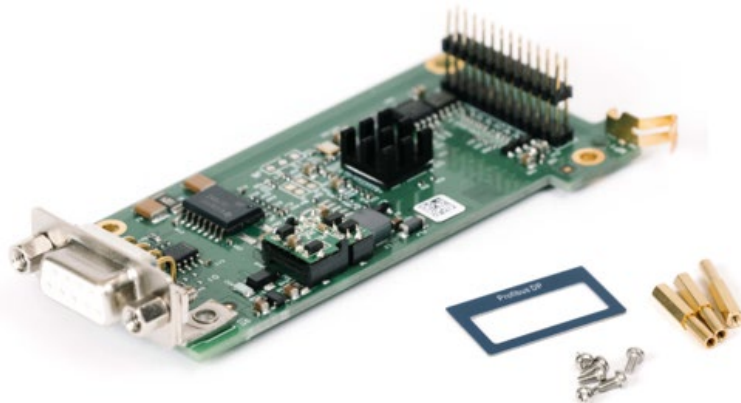

Part Description	Part No.
PCBA kit of Profibus DP connection for IND360 DIN and Panel mount versions, including enclosure opening tool	30601161

5.1.12. PCBA Kit Profibus DP IND360 HARSH



Part Description	Part No.
PCBA kit of Profibus DP connection for IND360 Harsh version	30601162

5.1.13. PCBA Kit, IE, IND360, DIN/PANEL



Part Description	Part No.
PCBA kit of Industrial Ethernet connection (PROFINET, EtherNet/IP, EtherCAT, CC-Link IE Field Basic or Modbus TCP) for IND360 DIN and Panel mount versions, including enclosure opening tool	30601155

5.1.14. PCBA Kit, IE, IND360 HARSH

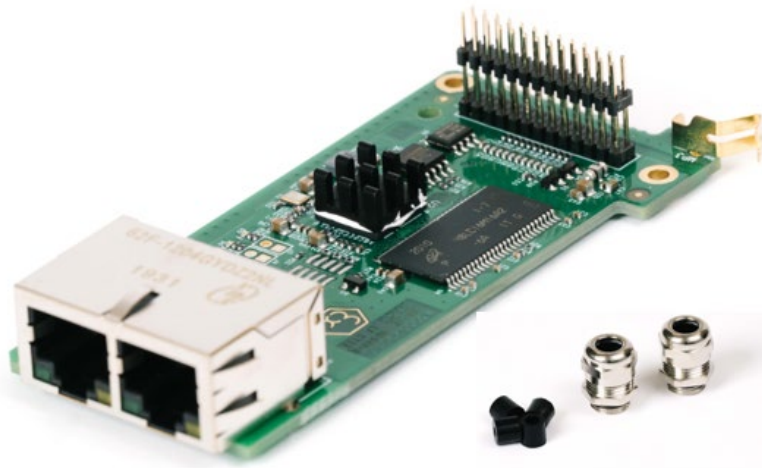

Part Description	Part No.
PCBA kit of Industrial Ethernet connection (PROFINET, EtherNet/IP, EtherCAT, CC-Link IE Field Basic or Modbus TCP) for IND360 Harsh version	30601156

5.1.15. Power Module APS324



Part Description	Part No.
AC/DC Power Module APS324.	30617714

5.1.16. Cable IND360 AC/DC to Main Board



Part Description	Part No.
Power supply cable from the APS324 power module to IND360	30617716

5.1.17. Cable, IND360, 11cm with Connector, PANEL

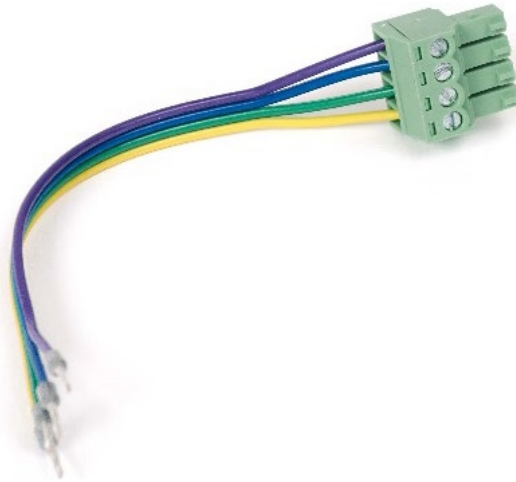

Part Description	Part No.
Display cable (11cm) from IND360 module to the panel. Use this when the IND360 module is mounted to the back of the panel.	30624030

5.1.18. Cable IND360 3m with Connector, PANEL

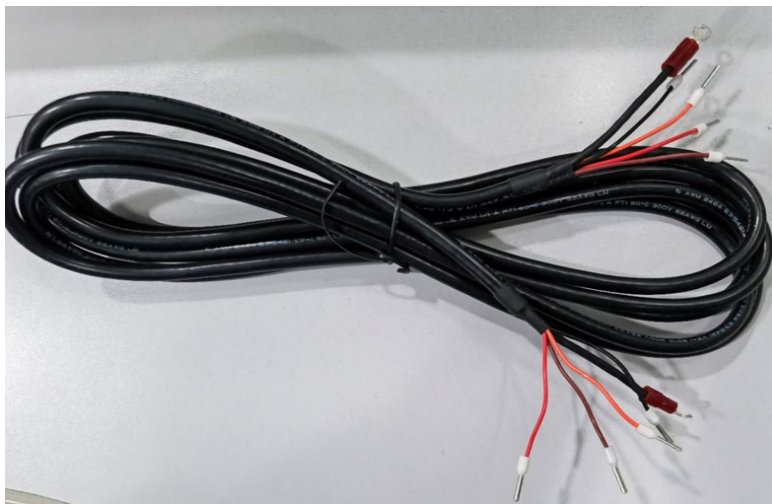

Part Description	Part No.
Display cable (3m) from IND360 module to the panel. Use this when the IND360 module is not mounted to the back of the panel.	30624029

5.1.19. Connector Kit, IND360

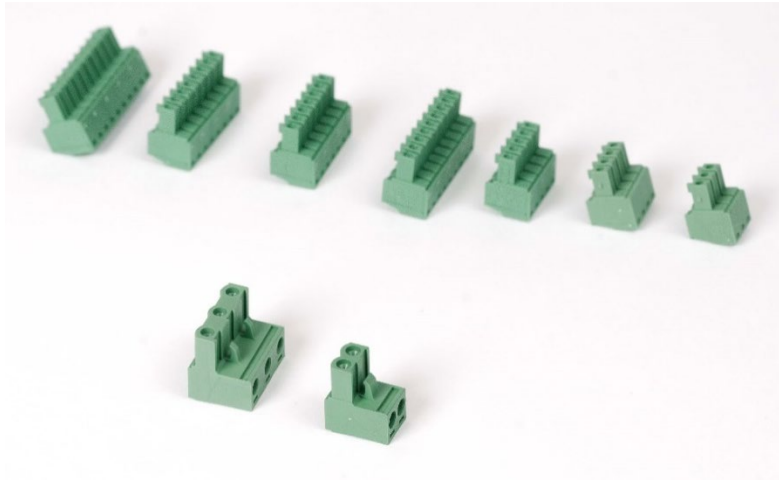

Part Description	Part No.
Complete set of IND360 connectors.	30624028

5.1.20. Opening Tool, IND360 DIN



Part Description	Part No.
Opening tool for IND360 DIN-mount version enclosure	30624077

5.1.21. Adjustable Desk Bracket VESA100



Part Description	Part No.
VESA100 Bracket to mount a IND360 Harsh version on desk or on wall	30462051

5.1.22. VESA mount 100mm x 100mm



Part Description	Part No.
Adjustable Column Bracket VESA100 for IND360 Harsh version	22020286

5.1.23. Connector G1/2"-M16 IND360 Harsh



Part Description	Part No.
G1/2"-M16 gland adapter for IND360 harsh. Required for FM approved hazardous applications.	30763036

5.1.24. Bracket Guard install Kit IND360xx Harsh



Part Description	Part No.
Bracket guard protects the connectors on the IND360 Harsh version for hazardous installations	30783230

5.1.25. Harsh External Metrology Sealing Kit



Part Description	Part No.
Weights and Measures Sealing Kit (harsh and panel) Includes 3 special screws, wire and plastic clasp/seal for W&M application. Additional plastic cover, metal bracket and 4 th unique screw are provided for W&M applications in China.	30130836
Spare wire seal	72996394

Part Description	Part No.
METTLER TOLED self-destructing security sealing label for W&M applications	68001451

5.2. Spare parts

5.2.1. M12 Cable Ethernet 5000mm



Part Description	Part No.
5m Ethernet cable M12 to RJ45	30101140

5.2.2. Display Board, IND360 P/H

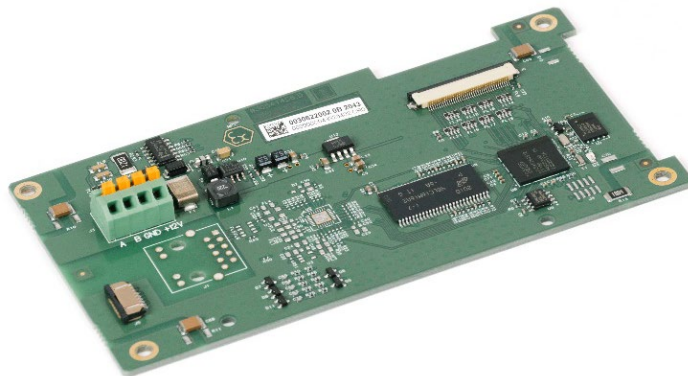

Part Description	Part No.
Display board of IND360 Panel mount and Harsh versions	30617688

5.2.3. Mainboard, IND360, Analog



Part Description	Part No.
Mainboard of IND360 for analog scales	30617689

5.2.4. Mainboard, IND360, Analog Legacy



Part Description	Part No.
Mainboard of IND360 for analog scales, legacy mode	30702041

5.2.5. Mainboard, IND360, POWERCELL



Part Description	Part No.
Mainboard of IND360 for POWERCELL® scales	30617690

5.2.6. Mainboard, IND360, Precision



Part Description	Part No.
Mainboard of IND360 for precision scales	30617691

5.2.7. AC/DC Power Board IND360



Part Description	Part No.
AC/DC power board of IND360	30617715

5.2.8. Panel, IND360, Keypad, no PCB



Part Description	Part No.
IND360 Panel display with keyboard overlay, no PCB	30617717

5.2.9. Panel Assy, IND360, with PCB



Part Description	Part No.
Complete IND360 Panel display with PCB	30617718

5.2.10. Cover IND360 Harsh without PCBAC



Part Description	Part No.
IND360 Harsh display cover with keyboard overlay, no PCB	30617719

5.2.11. Cover Assy, IND360, With PCBAC



Part Description	Part No.
Complete IND360 Harsh display cover with PCB	30617720

5.2.12. Cable, IND360, Precision M12



Part Description	Part No.
6cm cable for IND360 to connect precision scales with M12 connectors	30617721

5.2.13. Cable, IND360 PowerDeck M12



Part Description	Part No.
30cm M12 cable for IND360 to connect PowerDeck scales	30617722

5.2.14. Seal, IND360, Harsh



Part Description	Part No.
IND360 Harsh Environment version sealing	30617723

5.2.15. Seal, IND360, Panel



Part Description	Part No.
Sealing of IND360 Panel mount version	30617724

5.2.16. Overlay Kit, IND360 DIN

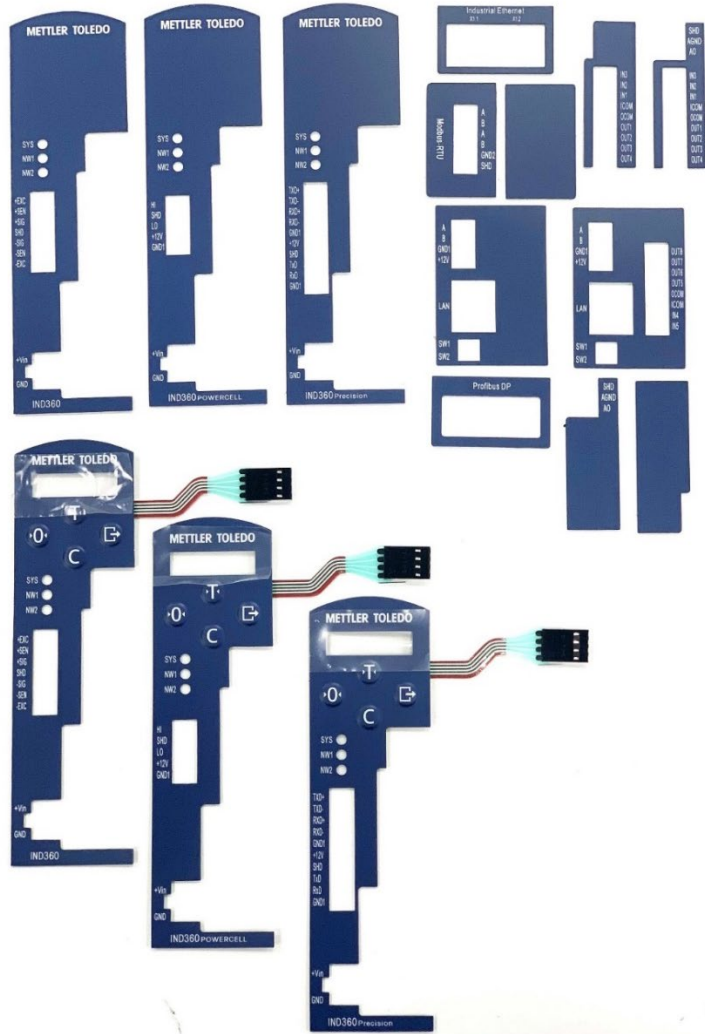

Part Description	Part No.
IND360 DIN mount version overlay kit	30624075

5.2.17. OLED Display, IND360 DIN

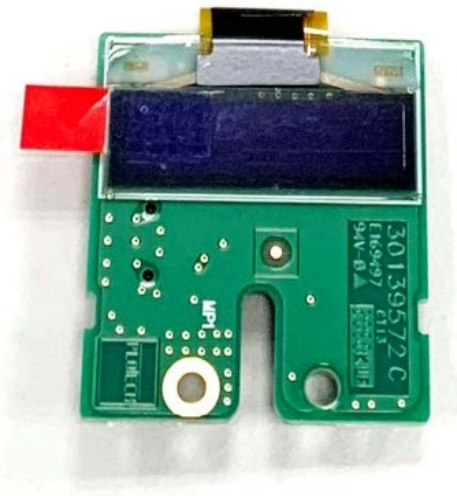



Part Description	Part No.
IND360 DIN mount version OLED display	30624076

A. Installation

This appendix provides installation instructions for the IND360 indicator DIN, panel-mount and harsh enclosures. Please read this appendix thoroughly before beginning installation.

Before installation, it must be noted that IND360 can only be installed and used in indoor environments whose Pollution Degree is 1 or 2.

	! WARNING
	DO NOT INSTALL, DISCONNECT OR PERFORM ANY SERVICE ON THIS EQUIPMENT BEFORE POWER HAS BEEN SWITCHED OFF OR THE AREA HAS BEEN SECURED AS NON-HAZARDOUS BY PERSONNEL AUTHORIZED TO DO SO BY THE RESPONSIBLE PERSON ON-SITE.
	! WARNING
	ONLY THE COMPONENTS SPECIFIED IN THE IND360 DOCUMENTATION CAN BE USED IN THIS INDICATOR. ALL EQUIPMENT MUST BE INSTALLED IN ACCORDANCE WITH THE INSTALLATION INSTRUCTIONS DETAILED IN THE INSTALLATION MANUAL. INCORRECT OR SUBSTITUTE COMPONENTS AND/OR DEVIATION FROM THESE INSTRUCTIONS CAN IMPAIR THE SAFETY OF THE INDICATOR AND COULD RESULT IN BODILY INJURY AND/OR PROPERTY DAMAGE.

A.1. Opening and Closing Enclosures

The following sections describe procedures for opening the different enclosures of IND360 indicator.

A.1.1. DIN Enclosure

The DIN-mount enclosure is only opened when option board/s are added or changed. An enclosure opening tool, shown in Figure A-1, is included in each accessory kit which requires opening the enclosure.



Figure A-1: IND360 DIN Enclosure Opening Tool (30624077)

To open the enclosure, position the two small tabs highlighted in Figure A-1 in the two holes on the rear enclosure (left of Figure A-2) and push toward the enclosure body. Repeat this

procedure for the other side. The front and rear enclosures will separate, as shown at right in Figure A-2.

- Do not use a screwdriver for this purpose because excess pressure will damage internal components.

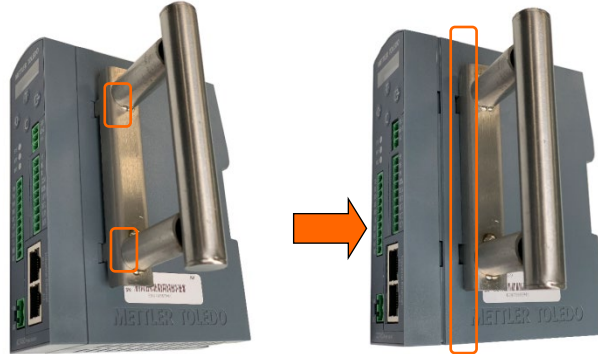

Figure A-2: Using the DIN Enclosure Opening Tool

Repeat the two steps on the other side of IND360 rear enclosure. The enclosure can then be opened as shown in Figure A-3.



Figure A-3: DIN Enclosure, Open

A.1.2. Panel-Mount Enclosure

The panel-mount version of the IND360 consists of several elements, as shown in Figure A-4. To open the DIN module or the Power Module, refer to section A.1.1.



Figure A-4: IND360 Panel-Mount Version Parts, AC Version

A.1.3. Harsh Enclosure

A.1.3.1. Opening the harsh Enclosure

The front panel of the harsh enclosure IND360 indicator is secured to the enclosure by eight Torx screws. Six screws are located at the top or bottom line of the rear enclosure. Two additional screws can be at the sides of the enclosure.



Figure A-5: Locations of Eight Torx Screws

Use a Torx screwdriver to remove or attach the Harsh enclosure's front panel.

A.2. Mounting the Indicator

The IND360 offers several mounting options:

- The DIN version IND360 indicator is intended to be installed on the standard 35mm DIN rail.
- The panel-mount enclosure is designed to mount into a cutout of a flat surface such as an instrument panel or industrial enclosure or door.
- The harsh enclosure is designed to be placed on a desktop or can be mounted to a vertical surface with the mounting brackets.

Mount the indicator where viewing is optimal, and the indicator keypad is easily accessible. Observe location and environment considerations as described in this manual. Do not install the IND360 in any position where it is difficult to operate or disconnect.

- Remove power from the unit before installation.

A.2.1. DIN-Mount Enclosure

The IND360 mounts to a standard DIN rail. The DIN mount has a three-point integral indicator grounding system, indicated in Figure A-6. The grounding points may vary, depending on the actual configuration.



Figure A-6: DIN-Mount Latch and Grounding System

To mount the IND360 on a rail, open the green latch by pulling down, then position the indicator so that its upper tabs rest on the DIN rail. Use a screwdriver to push the latch up and secure the indicator in place.

To detach the IND360 DIN version, simply put the blade of a screwdriver in the latch and press it downward.

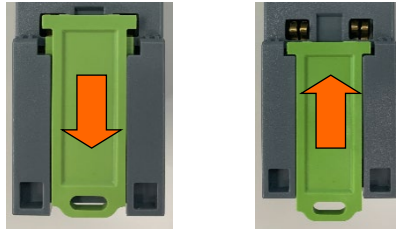

Figure A-7: DIN-Mount Latch Open (left) and Closed (right)

A.2.2. Panel-Mount Enclosure

The panel-mount version includes a panel display, 304 stainless steel bracket, four nuts, the weighing indicator module and power module (if applicable). The enclosure will mount and seal properly on panel thicknesses from 1.52 mm to 3.04mm (16 GA to 11 GA).

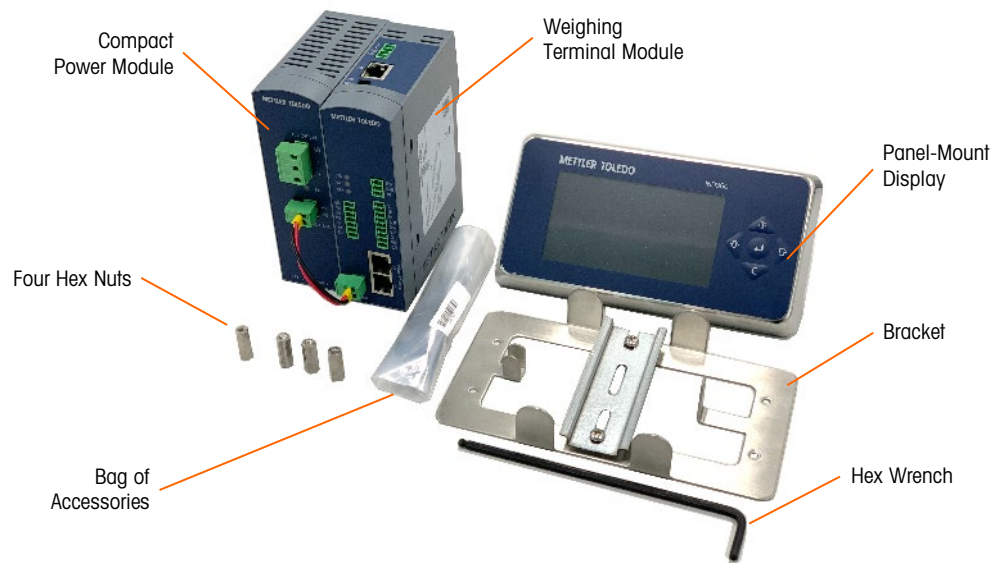

Figure A-8: IND360 Panel-Mount Version Parts, AC Version

To mount the IND360 Panel-Mount to a panel, four screw holes and one larger hole for the keyboard/video harness are required. This makes installation compatible with the IND331 Panel version. Figure A-9 shows dimensions in millimeters, as viewed from the front of the panel.

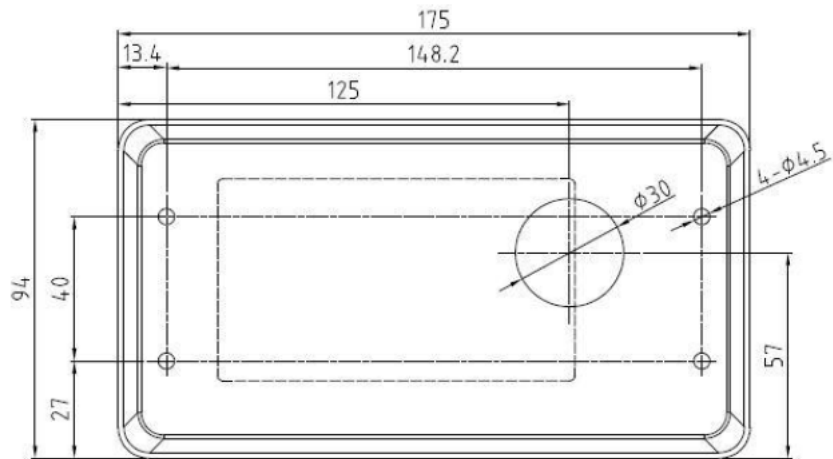

Figure A-9: Panel Mounting Template (Front View)

Next, mount the IND360 panel display to the panel. First, peel off the backing paper (shown partly and fully removed in Figure A-10) from the adhesive gasket surface.

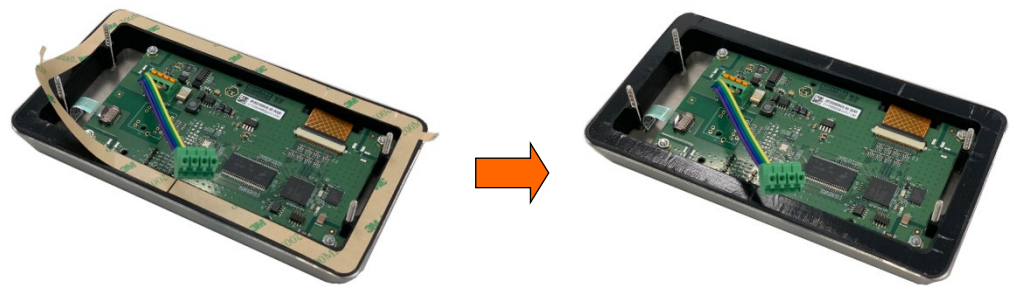

Figure A-10: Panel Mounting Template

Feed the keyboard/video harness through the larger hole in the panel. Use the adhesive rubber gasket to hold the panel display on the panel, as shown in Figure A-11.

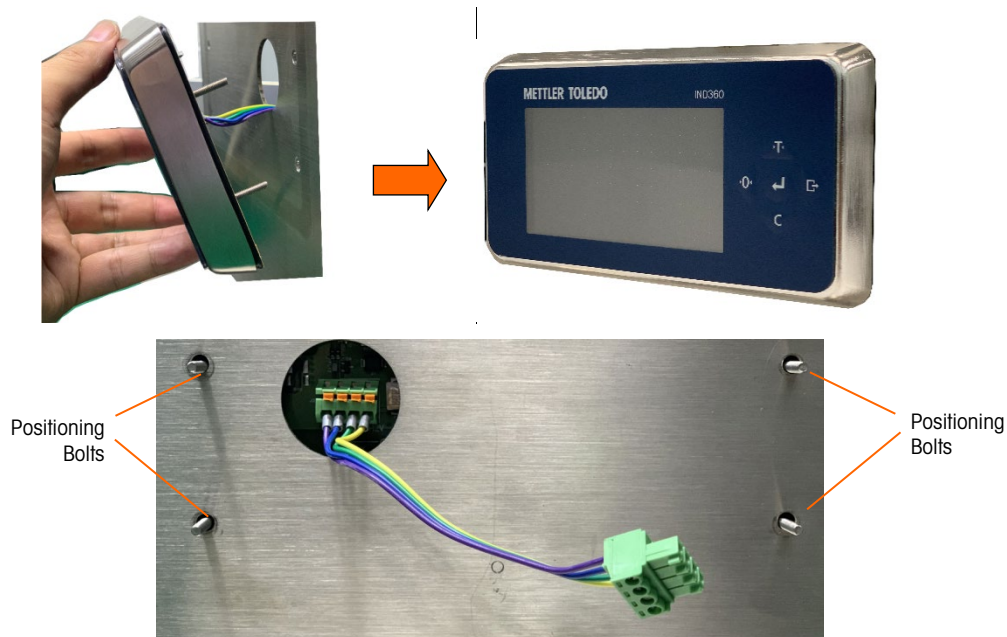

Figure A-11: Position the Panel Display on the Panel – Front (top) and Rear (bottom) Views

The standard keyboard/video harness connecting the panel-mount display operator interface assembly to the indicator module is designed to permit the weighing indicator module to mount directly to the back of the operator interface panel. This installation is described in the Direct Mounting section below and illustrated in Figure A-13 and Figure A-14.

The DIN enclosure may be mounted on the DIN bracket shown in Figure A-12, or on a separate DIN rail in the back of the enclosure. The keyboard/video harness between the operator interface and the indicator module can be replaced with a cable that extends the distance as far as 3m (10 ft). Remote mounting of the indicator module is described in the Remote Mounting section below, and shown in Figure A-15, Figure A-16 and Figure A-17.

Whichever method of mounting – direct or remote – is selected, please be noted the cabinet itself must be reliably grounded.

A.2.2.1. Direct Mounting

Install the indicator module on the bracket as shown in Figure A-12. The DIN rail supports mounting of both the indicator module and an optional APS324 AC power supply. Note that use of AC power on an enclosure door should first be confirmed with local safety authorities.

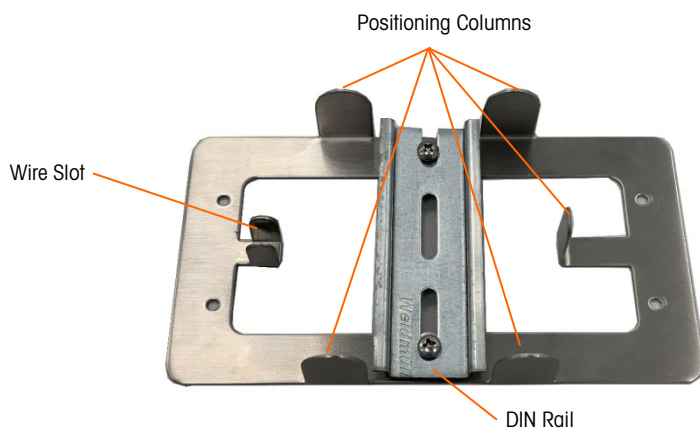

Figure A-12: IND360 Panel Bracket

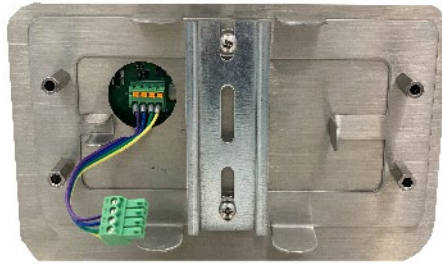

Figure A-13: Bracket Installation

Attach the bracket to the four bolts protruding through the enclosure (Figure A-13) and then mount the indicator module, or mount the weighing indicator module on the DIN rail (Figure A-14). Use a hex wrench shown in Figure A-8 to tighten the four nuts to the panel's mounting bolts.

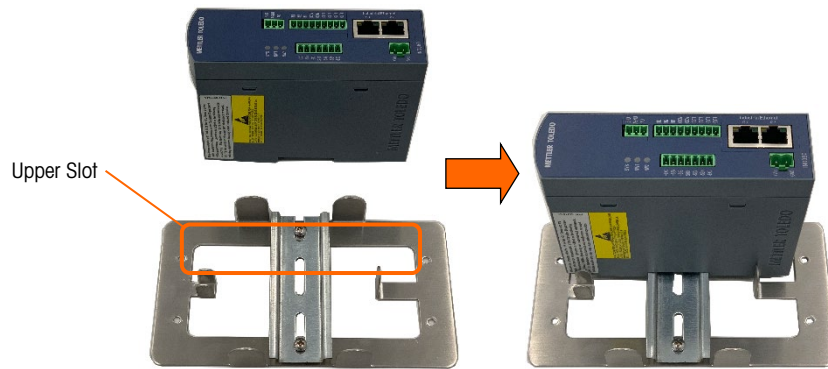

Figure A-14: Indicator Module Installation

Now, install the bracket with the indicator module to the back of the panel, locating it by the four positioning bolts (Figure A-11) on the panel display. Use the hex wrench to tighten the four nuts to hold the panel module in place.



Figure A-15: Install the Bracket on the Panel

Please note that the keyboard/video harness must pass through the wiring slot and then connect to the panel display port at the top of indicator module, as shown in Figure A-16.

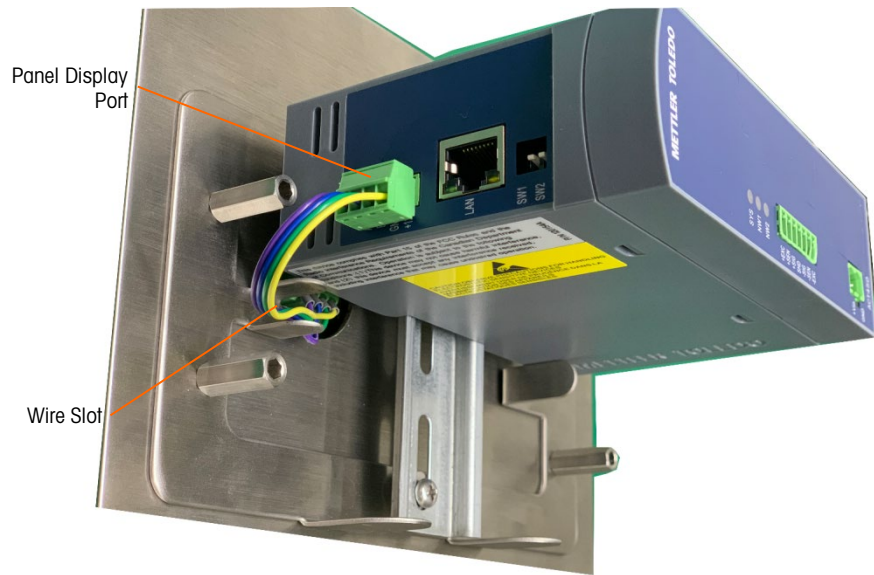

Figure A-16: Close-up to the Keyboard/Video Harness Installation

If a AC-DC power module is to be used, it should be installed after the display cable is connected. Refer to section A.2.1 to install the power module on the DIN rail.

A.2.2.2. Remote Mounting

If the indicator module is mounted at a distance from the front panel display, the panel should be secured with the four nuts as shown in Figure A-15.

With the panel module installed, remove the short harness wires from the back of the display assembly by pressing the small orange lever beside each indicator (Figure A-17) and pulling the wire out. The harness should be completely removed from the display. Remove the four-position indicator block from the other end of the harness.

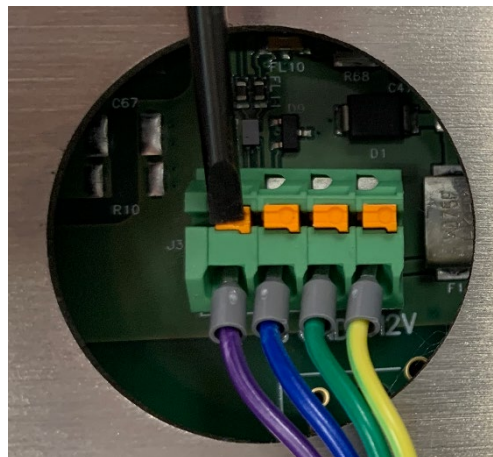
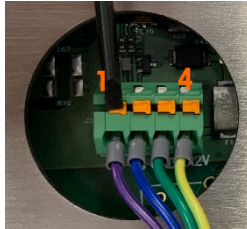

Figure A-17: Orange levers on display board connector

Install the four-position indicator block on one end of a new cable with suitable length and connect the other end to the panel display port connector located on the top of indicator module, as indicated in the following table. The cable used should be a shielded, four conductor cable in which each conductor is a minimum of 0.76 mm (22 GA). The maximum cable length for remote mounting is 15m (50 ft). To prevent electrical interference on cables

more than 2m (6 ft) long, the shield should be grounded to one of the studs on the back of the panel display.

Table A-1: Display Harness Wiring



PIN No.	MT Wire Color	Signal	PIN No.
1	Purple	A	1
2	Blue	B	2
3	Green	GND	3
4	Yellow	+12V	4
	Chassis Ground	Shield	No Connection

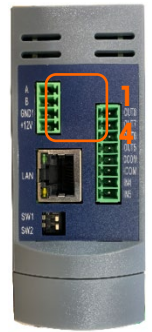

A.2.3. Harsh Enclosure

The harsh enclosure is made of 304 stainless steel with a front panel angle of approximately 10 degrees. This enclosure is designed to rest on a flat surface such as a table or desktop, or to be mounted to a vertical surface using the mounting brackets available as an optional accessory with the indicator.

A.2.3.1. Desktop Mounting

To place an IND360 on a desktop, the four rubber feet included in the package should be adhered to the bottom of the enclosure to prevent sliding. Locate the four rubber feet, remove the protective paper from the adhesive, and press the feet onto the corners of the bottom of the enclosure as shown in Figure A-18.

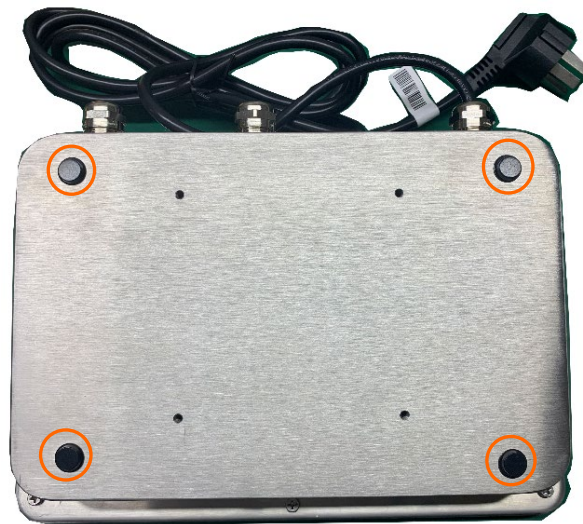

Figure A-18: Rubber Feet Attached

A.2.3.2. Wall Mounting

Two angled brackets are available as an option (material number 178057) with a harsh model IND360 for use when mounting the enclosure to a vertical surface. To wall mount the enclosure, follow these steps:

1. Bolt the two brackets to the bottom of the enclosure using the four M4 screws included with the indicator. The brackets should be attached as shown in Figure A-19.

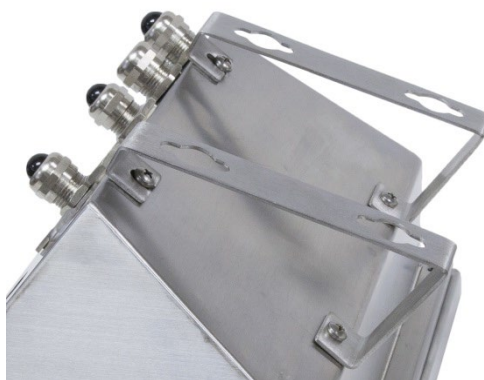

Figure A-19: Attaching the Wall-Mounting Brackets

1. If the enclosure will be mounted above eye level, proceed to step 4.
2. If the enclosure will be mounted at or below eye level, it will be necessary to reverse the front cover 180 degrees. To reverse the front cover, perform the following steps:
 - a. Open the enclosure per the instructions provided in the A.1.3.1 Opening the Enclosures section.
 - b. Loosen and remove the two nuts securing the two grounding straps (which also function as hinges for the front cover) to the indicator module, as well as disconnect the panel display port connector – see Figure A-20.

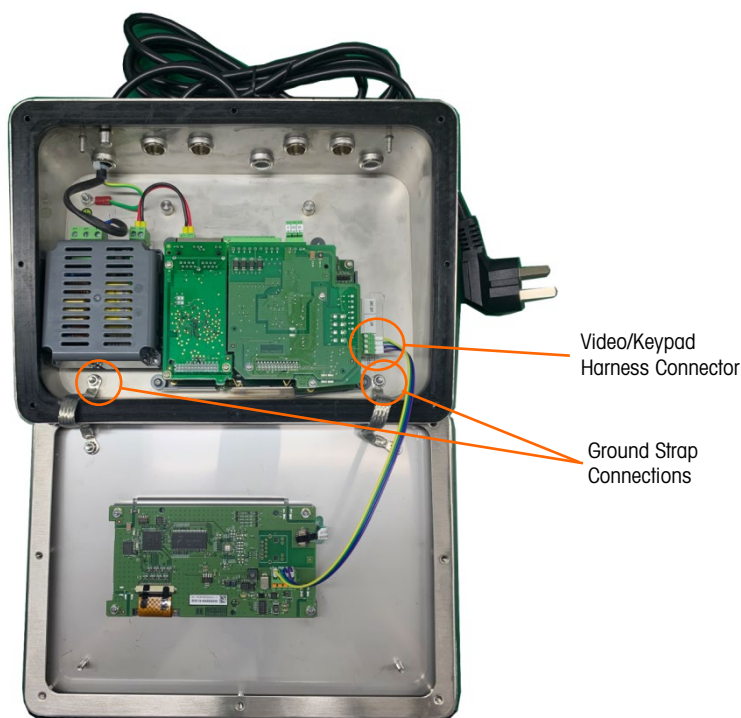

Figure A-20: Loosening the Ground Straps

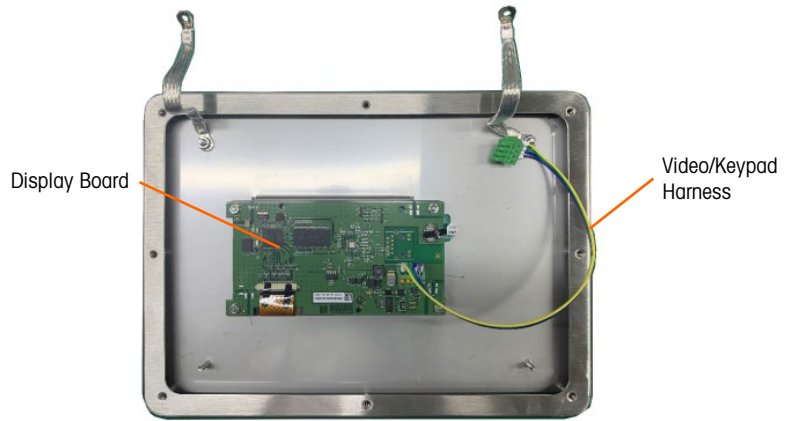

Figure A-21: Front Panel Removed

- c. Carefully rotate the front cover 180 degrees and reattach the two grounding straps to the two studs near the grip bushings using the two nuts removed in the previous step as shown in Figure A-22. Tighten the two nuts.

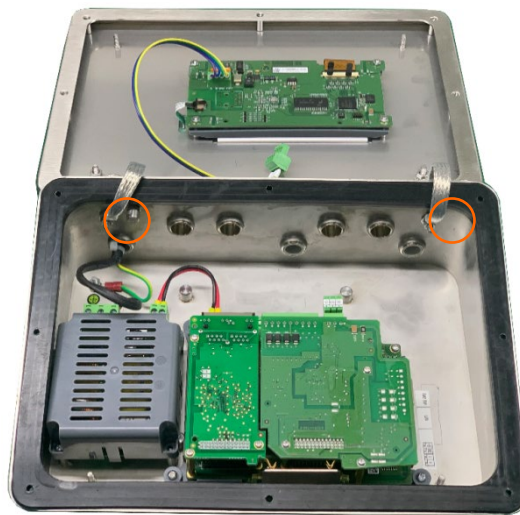

Figure A-22: Front Panel Reversed

3. Mark the position of the mounting holes on the vertical surface per the dimensions shown in Figure A-23, or by holding the indicator up to the surface and marking through the bracket holes.

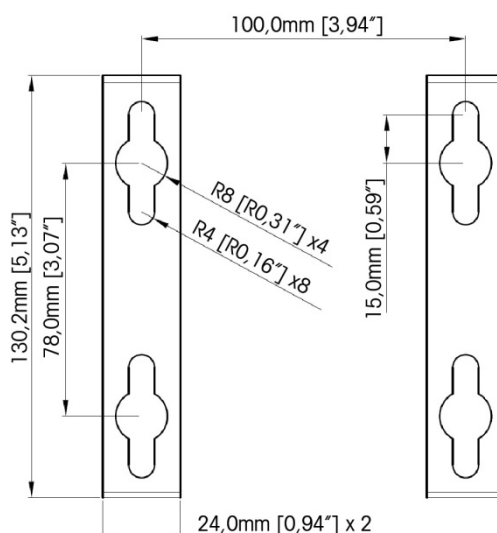

Figure A-23: VESA 100 x 100mm Wall Bracket Mounting Hole Pattern

4. The hardware to mount the indicator to the vertical surface is not included with the indicator – it must be supplied locally. Ensure that the mounting hardware is capable of supporting the weight of the indicator, which is approximately 3.6 kg (8 lb). Using the locally supplied hardware, mount the indicator to the vertical surface.

A.3. Installing Cables and Connectors

This section provides information about installing cables and connectors for the IND360 indicator, including ferrites, harsh enclosure cable glands, main board wiring connections and wiring connections for options.

Please note that the power must be switched off before installing any part or option, and before connecting the IND360 to any external device such as PLC, load cell or junction box. Once the IND360 is powered off, connectors can be unplugged.

A.3.1. Ferrites

In order to meet certain electrical noise emission limits and to protect the IND360 from external influences, it is necessary to install a ferrite core on each cable connected to the indicator. Two ferrite cores are included with the basic indicator, and additional ferrites are supplied with each of the options.

To install ferrites, simply route the cable through the center of the core and then take one wrap around the outside of the core and route the cable through again. Either the complete cable or the individual wires can be wrapped through the ferrite. This should be done as close to the enclosure as possible (Figure A-24).



Figure A-24: Installing the Ferrite Cores

A.3.2. Harsh Enclosure Cable Openings

Figure A-25 and Table A-2 show the uses of the glands and other openings on the rear of the harsh enclosure.

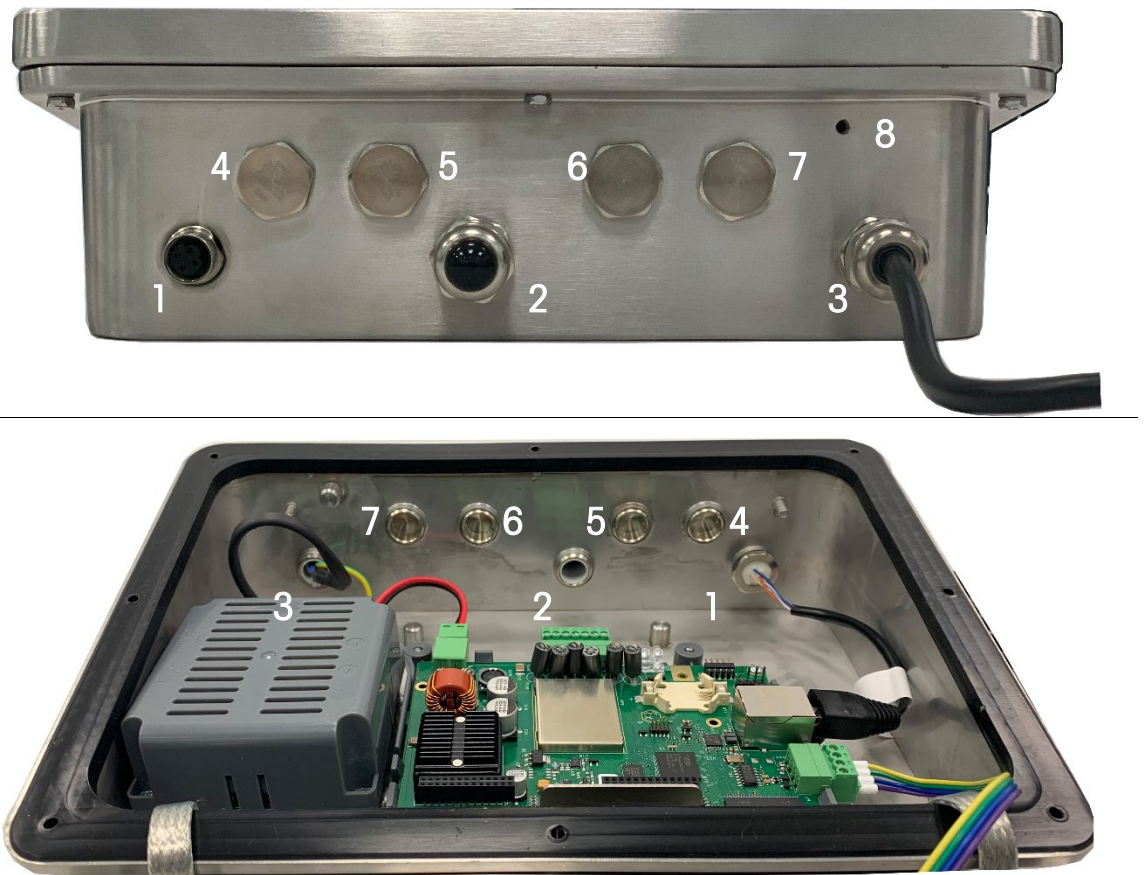

Figure A-25: Harsh Enclosure Cable Opening Assignments (External and Internal Views)

Table A-2: Harsh Enclosure Cable Openings

Number	Use	Cable Gland Size, mm
1	Service Ethernet TCP/IP, M12 connector	16
2	Load cell or Weigh Module Connection (Strain gauge, POWERCELL or Precision)	16
3	AC Power	16
4	4~20mA/O~10V analog output	16
5	DI/O	16
6/7	PLC options (PROFINET, PROFIBUS DP, EtherNet/IP, EtherCAT, CC-Link IE Field Basic, Modbus TCP or Modbus RTU)	16
8	POWERCELL PDX Outer Drain Wire Connection	

A.3.3. Harsh Enclosure Cable Glands

The IND360 harsh environment indicator is designed to withstand severe washdown environments and is certified to IP69K ingress protection. However, care must be taken when

installing cables and/or connectors that enter the indicator enclosure. To ensure a watertight seal:

1. Pass the cables through an appropriately sized cable grip before connecting the wires. Figure A-26 shows one load cell cable installed in its cable grip, and a second grip disassembled.



Figure A-26: Cable Glands

2. Depending upon the diameter of the cable to be installed, select one of the two different sized rubber grommets (if required) to properly seal around the cable. The grommets are packaged in the accessory bag.



Figure A-27: Different Sized Rubber Grommets

Table A-3: Grommet Cable Sizes

Grommet	Cable Diameter
None	7–10 mm (0.28–0.39 in.)
Larger size hole	5– 6 mm (0.20–0.24 in.)
Smaller size hole	3–4 mm (0.12–0.16 in.)

3. When making cable terminations inside the harsh enclosure, ensure that the cable length from the terminal strip/connector to the indicator housing is sufficient so that no strain is placed on the connector assembly when the housing is in the fully open position.
4. After making the wiring connections as described in the next section, ensure the nut on the cable gland is tightened properly to seal around the cable. Ensure that this seal is watertight.
5. Cable shielding should be grounded to the IND360's enclosure by spreading the shield wires as shown as step 1 in Figure A-28, then folding them back over the plastic component of the cable gland (step 2) before pressing it into the threaded body(step 3).
6. When fastening the gland back to Harsh enclosure, use a wrench to tighten to 5 N-m torque.

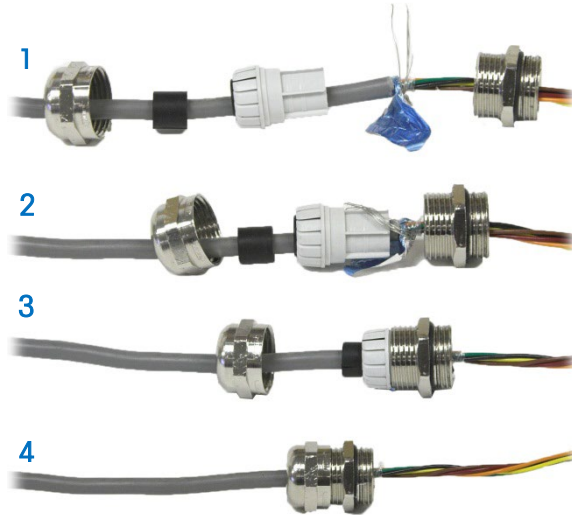

Figure A-28: Cable Shield Grounding

A.3.4. Ethernet Connection

IND360 uses Webserver over the standard Ethernet connection as the service, maintenance and configuration tool.

The default IP address is 192.168.0.8.

A.3.4.1. DIN or Panel-Mount Enclosure

The Ethernet port is located on top of the weighing indicator, as indicated in Figure A-29. It supports standard RJ45 connector.

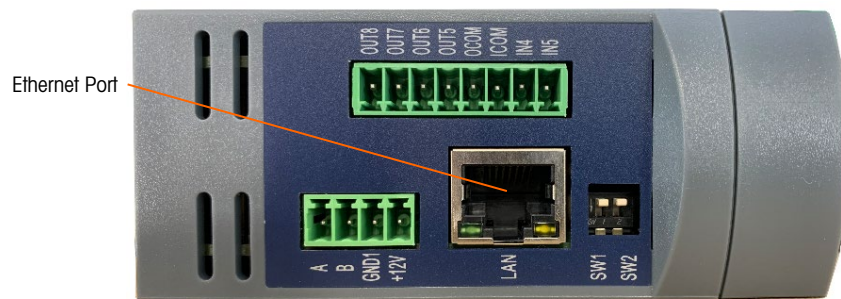

Figure A-29: Ethernet Connection – DIN or Panel-Mount Models

A.3.4.2. Harsh Enclosure

An M12 connector for the service port Ethernet connection is used for the Harsh enclosure. To connect the IND360 Harsh to Ethernet, an RJ45 to M12 converter cable is used (shown in Figure A-25 and listed in Table A-2). This cable is available as an optional accessory for IND360.



Figure A-30: Ethernet Connection – Harsh Model

A.3.5. Power Connection

- NOTE: The integrity of the power ground for equipment is important for both safety and dependable operation of the indicator and its associated scale base. A poor ground can result in an unsafe condition should an electrical short develop in the equipment. A good ground connection minimizes extraneous electrical noise pulses.
- NOTE: The IND360 should not share power lines with noise-generating equipment. To confirm ground integrity, use a commercial branch circuit analyzer. If adverse power conditions exist, a dedicated power circuit or power line conditioner might be required.



A permanently attached line cord supplies the AC power to the harsh enclosure version of the IND360 indicator. The panel-mount or DIN enclosure is not supplied with a power cord –it is designed to have AC or 24 VDC wiring brought directly to the rear of the chassis and connected to the incoming power terminal strip.

	! WARNING
	ENSURE THAT THE POWER CONNECTION TO THE IND360 MATCHES THE SPECIFIED OPERATING VOLTAGE OF THE INDICATOR. REFER TO THE DATA LABEL OF THE INDICATOR FOR THE OPERATING VOLTAGE. CONNECTING THE INCORRECT POWER SOURCE TO THE INDICATOR COULD RESULT IN DAMAGE TO OR DESTRUCTION OF THE EQUIPMENT AND/OR BODILY HARM.

A.3.5.1. AC Powered Models

When an IND360 is configured for AC power, the two AC power connections are marked “L” for line (hot) and “N” for neutral as shown in Figure A-32 (Panel-Mount) and Figure A-33 (Harsh). A loop terminal and ground screw are provided for the ground connection on the panel and harsh mount. A grounding symbol  appears next to the loop terminal. AC powered harsh models have the power ground installed with the region appropriate power cord.

No voltage or frequency settings are required since IND360 includes either a universal AC power supply that operates from 85 to 264 VAC. The AC indicator requires 85 to 264 VAC (at start-up 0.8A maximum) with a line frequency of 49 to 61 Hz of power.

	 WARNING
	<p>FOR CONTINUED PROTECTION AGAINST SHOCK HAZARD CONNECT TO PROPERLY GROUNDED OUTLET ONLY. DO NOT REMOVE THE GROUND PRONG.</p> <p>FOR THE HARSH VERSION, FOR PROTECTION AGAINST SHOCK HAZARD DO NOT USE WET HANDS TO PLUG IN OR UNPLUG THE POWER CORD FROM OUTLET.</p>

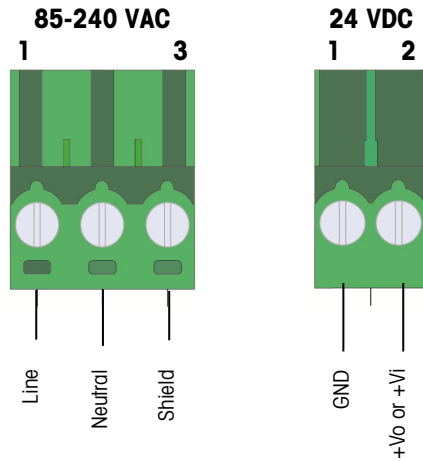

Figure A-31: Incoming Power Termination



Figure A-32: AC Power Connection on Panel Mount Power Module

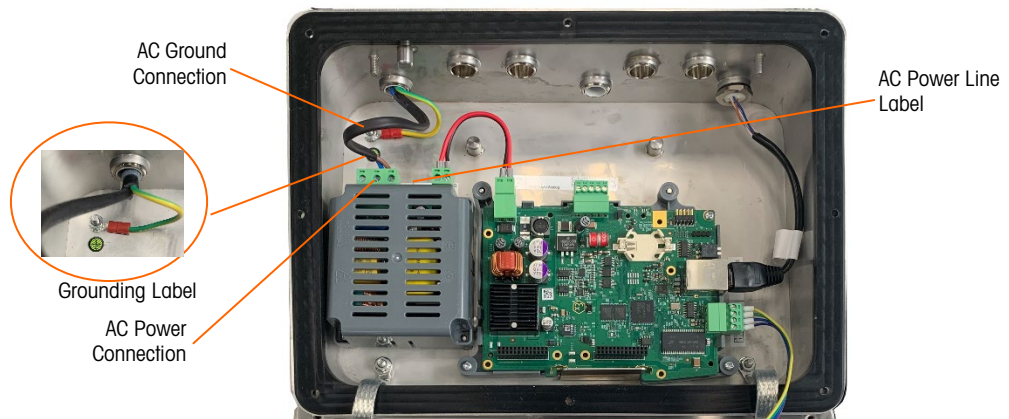

Figure A-33: AC Power Connections on Harsh Models

A.3.5.2. DC Powered Models

By selecting “DC” in the power supply option, use external 24VDC provided by user. IND360 requires in this case 24 (20 ~ 28) VDC max., 0.8A at start-up.

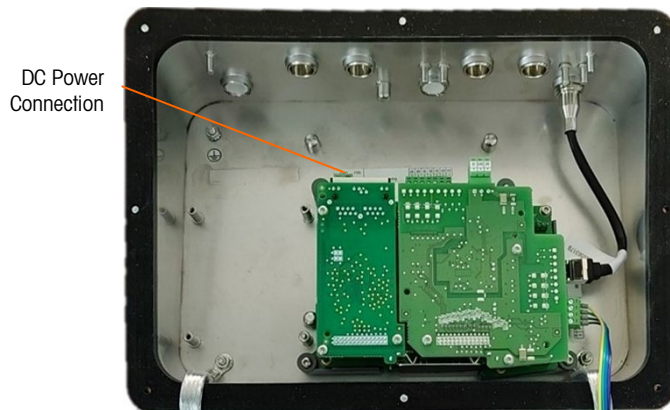

Figure A-34: DC Power Connection Harsh Models

A.3.6. Main Board Wiring Connections

Once the IND360 indicator harsh enclosure is open, connections can be made to the terminal strips on the main board, as shown in Figure A-35 to Figure A-37.

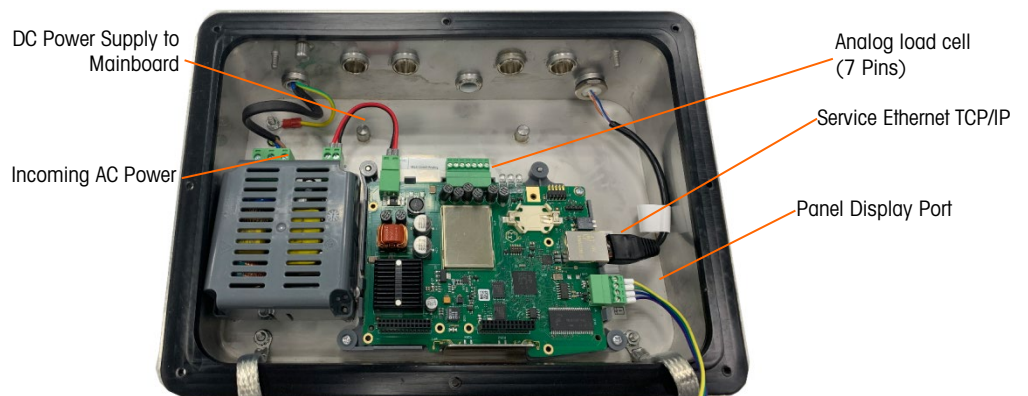

Figure A-35: Analog Main Board in Harsh Enclosure



Figure A-36: POWERCELL Main Board in Harsh Enclosure



Figure A-37: Precision Main Board in Harsh Enclosure

The IND360 Panel-Mount (at left in Figure A-38) or DIN (at right in Figure A-38) versions share the weighing electronics module, except for the OLED display. It is not necessary to open the enclosure to make these connections.

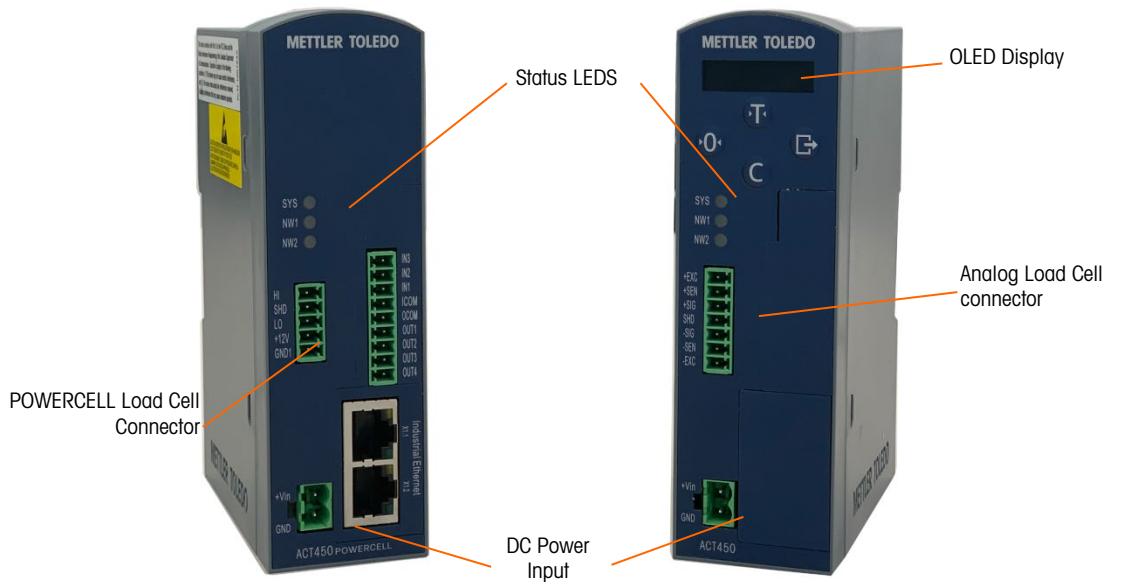

Figure A-38: Panel Mount and DIN Enclosure Connections

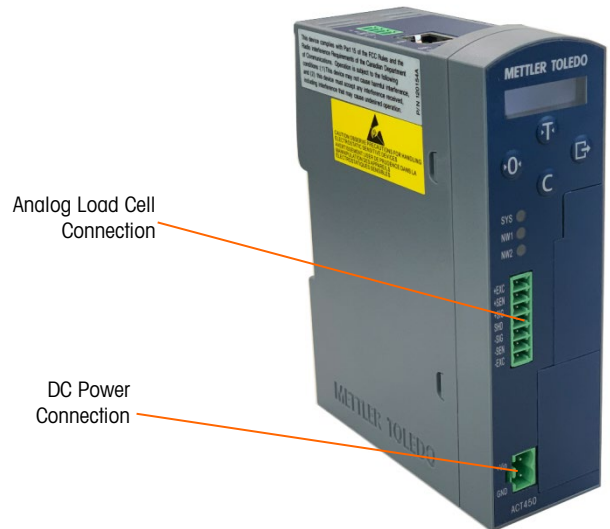

Figure A-39: DIN Model with Analog Load Cell Connection

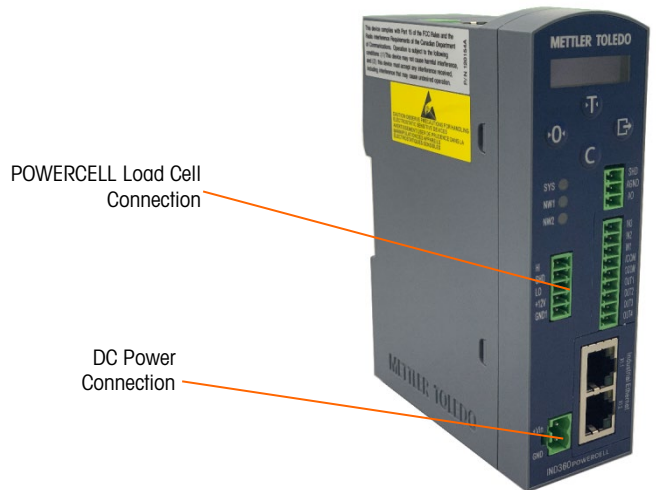

Figure A-40: DIN Model with POWERCELL Load Cell Connection

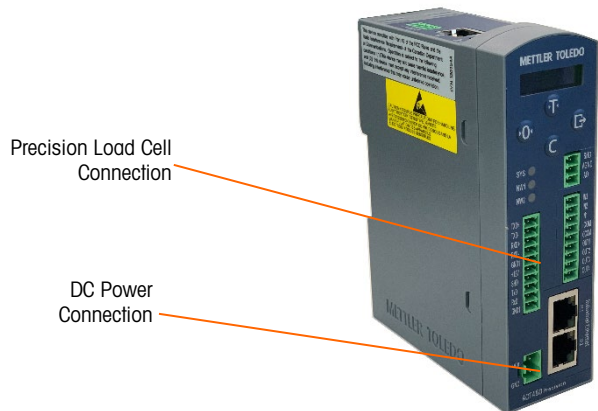

Figure A-41: DIN Model with Precision Load Cell Connection

A.3.6.1.

Analog Load Cell Connections

NOTICE

TO AVOID DAMAGE TO THE PCB OR LOAD CELL, REMOVE POWER FROM THE IND360 AND WAIT AT LEAST 30 SECONDS BEFORE CONNECTING OR DISCONNECTING ANY HARNESS.

When using an analog load cell version of the IND360, load cell connections are made to the connector located on the main board as shown in Figure A-35 and Figure A-39.



Figure A-42: IND360 Harsh Enclosure, Analog

The IND360 indicator is designed to power up to eight 350-ohm load cells (or a minimum resistance of approximately 29 ohms). To confirm that the load cell load for this installation is within limits, the total scale resistance (TSR) must be calculated. To calculate TSR:

$$\text{TSR} = \frac{\text{Load Cell Input Resistance (Ohms)}}{\text{Number of Load Cells}}$$

Ensure that the TSR of the load cell network to be connected to the IND360 has a resistance greater than 29 ohms before connecting the load cells. If the resistance is less than 29 ohms, the IND360 will not operate properly.

In addition, the maximum cable distance must be reviewed. Table A-4 provides recommended maximum cable lengths based on TSR and cable gauge.

Table A-4: Recommended Maximum Cable Lengths

TSR (Ohms)	24 Gauge (0.61mm) (meters/feet)	20 Gauge (0.91mm) (meters/feet)	16 Gauge (1mm) (meters/feet)
350	243/800	610/2000	1219/4000
87 (4-350 Ω cells)	60/200	182/600	304/1000
43 (8-350 Ω cells)	30/100	91/300	152/500

Figure A-43 shows the terminal definitions on the analog load cell terminal strip. Note that when using four-wire load cells, jumpers must be placed between the +Excitation and +Sense terminals and between the –Excitation and –Sense terminals.

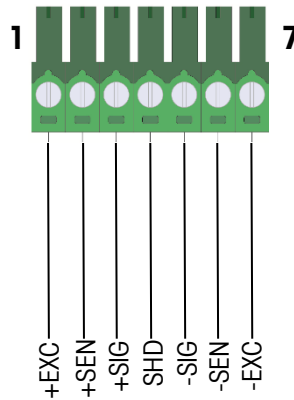

Figure A-43: Load Cell Termination

- Note that, for the standard four-wire cable, if an increase in load results in a decrease in weight display, reverse the signal wires (+SIG and -SIG).

A.3.6.2. APW Module Connections

The IND360 indicator supplies 12 VDC for APW Weigh Modules.

The Harsh version uses the center of the lower glands to connect to APW Weigh Modules.



Figure A-44: IND360 Harsh Enclosure, Precision

The precision version of the IND360 uses a 10-pin connector to connect an APW Weigh Module. Connection details are shown in Figure A-45 and Table A-5. Only wire one of the RS communication options (RS232, RS422 or RS485) according to the weigh module connected.

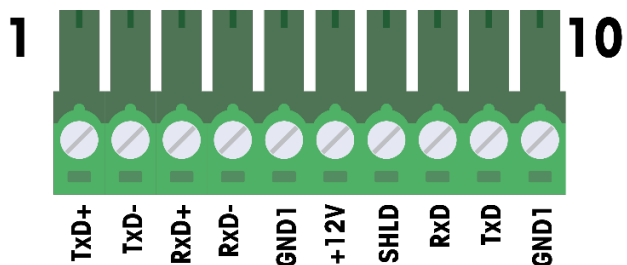

Figure A-45: Precision Connector Cell Termination

Table A-5: IND360 Precision Pin Assignments using cable 30244446 or 30244447



















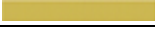







IND360 Pin		Weigh Module Signal			APW Products Examples	
Pin No.	Signal	RS232	RS422	RS485	PBK-9; PFK-9, SLF-6; WKC	Cable Colors
1	TxD+		Rx+	RS485+	Black	
2	TxD-		Rx-	RS485-	Violet	
3	RxD+		Tx+	RS485+	Orange	
4	RxD-		Tx-	RS485-	Purple	
5	GND1	GND	GND	GND	Brown Green	 
6	+12V	VDC	VDC	VDC	White	
7	SHLD	SHLD	SHLD	SHLD	Braid	
8	TxD	RxD			Pink	
9	RxD	TxD			Yellow	
10	GND1	GND			Red	

Table A-6: IND360 Precision Pin Assignments using cable 30844498 or 30838247

IND360 Pin		Weigh Module Signal			APW Products Examples	
Pin No.	Signal	RS232	RS422	RS485	PBK-9; PFK-9, SLF-6; WKC	Cable Colors
1	TxD+		Rx+	RS485+	grey/blue	 / 
2	TxD-		Rx-	RS485-	pink/black	 / 
3	RxD+		Tx+	RS485+	brown/green	 / 
4	RxD-		Tx-	RS485-	white / yellow	 / 
5	GND1	GND	GND	GND	Black White	 
6	+12V	VDC	VDC	VDC	Red	
7	SHLD	SHLD	SHLD	SHLD	Braid	
8	TxD	RxD			Pink	
9	RxD	TxD			Yellow	
10	GND1	GND			grey	

A.3.6.3. Precision Platform Connections

METTLER TOLEDO precision platforms use M12 connectors for indicators / transmitters. In this case, use the cable shown below to convert the 10-pin connector of IND360 to a M12 connector, so the precision platform can be easily connected without having to cut any wires. The cable is part of the delivery when option 4 is chosen in the SCK (refer to Figure 1-1 in Chapter 1, Introduction).

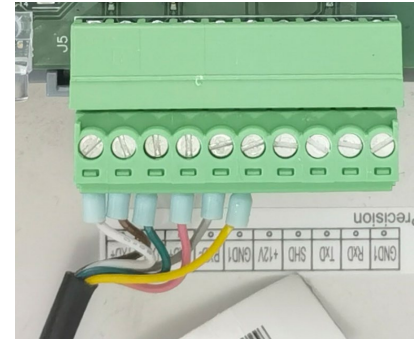



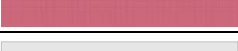
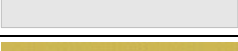



Figure A-46: M12 Cable for Precision Platforms

The wiring information is shown below:

Table A-7: M12 Cable for Precision Platforms Wire Signal Definition

IND360 Connector Pin No.	IND360 Signal	Cable Colors	
1	TXD+	White	
2	TXD-	Brown	
3	RXD+	Green	
4	RXD-	Pink	
5	GND1	Grey	
6	+12	Yellow	
7 - 10	-	Not connected	

A.3.6.4. POWERCELL Connections

The IND360 Harsh uses the center of the lower glands shown in in Figure A-47 to connect to POWERCELL load cells.



Figure A-47: IND360 Harsh Enclosure, POWERCELL

For DIN or Panel Mount enclosure types, see Figure A-38 and Figure A-40 to connect to POWERCELL load cell.

A.3.6.4.1. Harsh Enclosure

Preparing the indicator for use with POWERCELL load cells involves three phases:

- Preparation of the cable and gland
- External connection and grounding of the cable
- Internal connection and grounding of the cable.

Each of these steps must be correctly completed to ensure the correct function of the POWERCELL network.

A.3.6.4.2. Cable and Gland Preparation, Harsh Enclosure

Ground and shield terminations are a critical part of the POWERCELL PDX system’s immunity to noise and electrical surges. Prepare and install the indicator end of the POWERCELL PDX home run cable as follows – see Figure A-48 and refer to Table A-8.

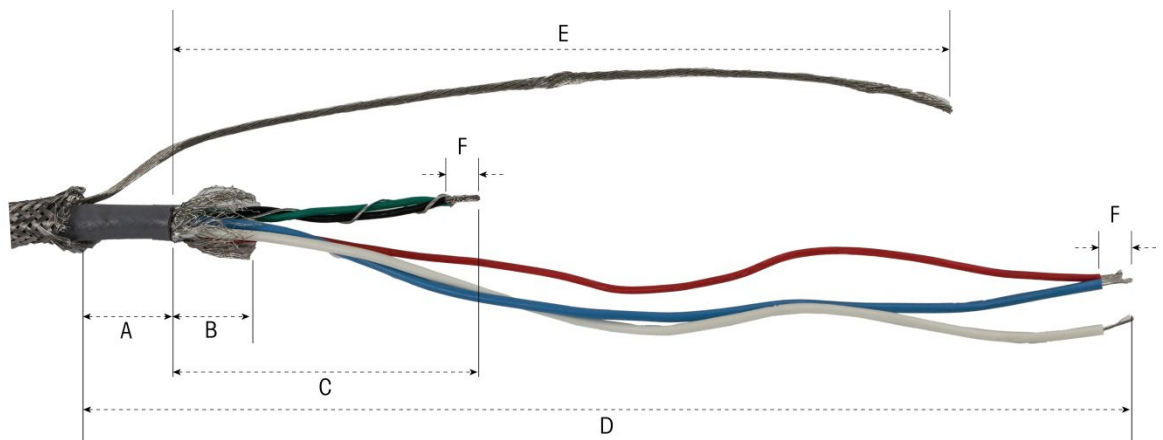

Figure A-48: POWERCELL Cable Preparation – Harsh

Table A-8: Cable Preparation Lengths – Harsh

Letter	Description	Length
A	Length of cable jacket from outer braided shield	25 mm (1.0 in)
B	Length of inner braided shield and foil	25 mm (1.0 in)
C	Length of black and green wires and of internal drain wire	70 mm (2.75 in)
D	Length of red, blue and white wires	229 mm (9 in)
E	Length of outer shield drain wire from end of cable jacket	216 mm (8.5 in)
F	Length of insulation to strip from wires	5 mm (0.2 in)

1. Make sure that the un-terminated end of the POWERCELL cable is cut cleanly.
2. Mark the exterior braided armor 255 mm (10”) from the end of the cable.
3. Use metal shears to cut along the exterior braided armor, taking care not to cut into the cable jacket or the outer drain wire.
4. Trim the exterior braided armor back to the cut mark and remove stray wires from the cut.
5. Mark the cable jacket 25 mm (1”) cm from the cut end of the exterior braided armor.
6. Using a razor knife, cut carefully around the cable jacket, without cutting into the inner braided shield.

7. Use the razor knife to cut along the cable jacket, so that it can be peeled off the wires. Again, take care to cut only the cable jacket, and not its contents: push the knife deep enough into the cable jacket until it is just possible to feel the tip of the blade drag on the inner braided shield.
8. Peel the cut jacket off the inner braided shield.
9. Mark the inner braided shield 1" (25 mm) from the cut end of the cable jacket.
10. Carefully cut around the inner shield at the cut mark, without cutting into its contents. Remove the cut portion of the inner shield from the cable.
11. Unscrew the outer sealing portion of the POWERCELL cable gland from the indicator and disassemble the cable clamp. Set the clamps and screws aside in a safe place.
12. Use two wrenches to remove the nut holding the body of the POWERCELL cable gland to the indicator enclosure and remove the gland.
13. Slide the outer sealing part of the gland down the prepared cable, keeping the outer drain wire outside the body. Position the gland against the cut end of the exterior braided armor. Note the orientation of the gland – the clamping features should be toward the exterior braided armor.

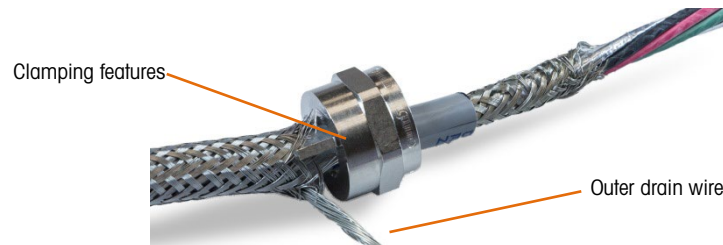

Figure A-49: Outer Portion of Cable Gland Installed on Cable

14. Slide the plastic grommet down the cable and fit it into the gland. The end of the plastic grommet should align with the end of the cable jacket.

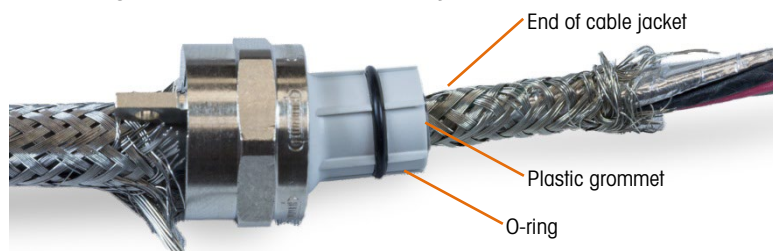

Figure A-50: Plastic Grommet Positioned in Gland

15. Unbraid the individual strands of the inner braided shield.



Figure A-51: Inner Shield Unbraided

16. Fold the individual strands of the inner braided shield back over the grommet. The individual strands should be uniformly distributed around the outer surface of the grommet.

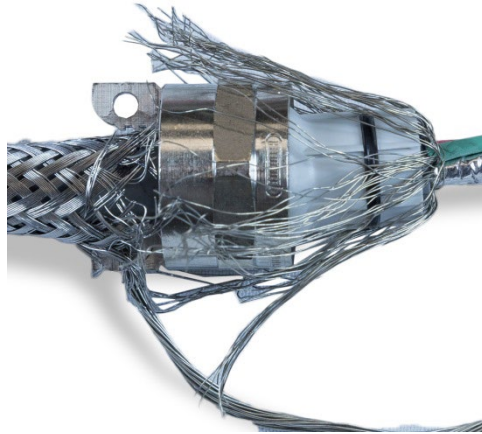

Figure A-52: Inner Braided Shield Folded Back over Grommet

17. Separate the individual wires in the cable – the green, red, and black wires, the inner drain wire, the blue and white wires and their foil wrapper. The nylon string, used only during manufacture, can be cut off.

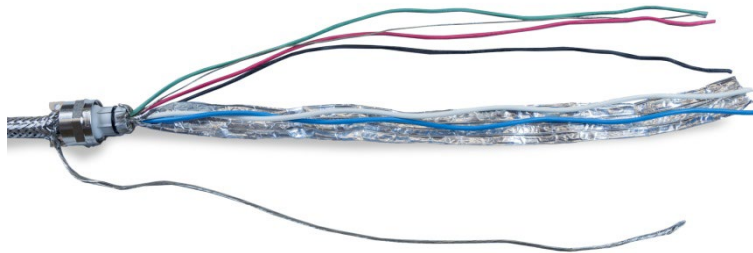

Figure A-53: Cable Components Separated

18. Cut the foil back to about an inch (25 mm) from the end of the plastic grommet. Snip lengthwise to allow it to fold back all around the grommet, and cut both foil and inner braided shield wires so that they cover the end of the plastic grommet, without covering the O-ring.



Figure A-54: Inner Braided Shield Wires and Foil Trimmed to Length and Folded Back Over Grommet

19. Slide the body of the cable gland (removed in step 12) down the wires. Note the orientation of the body of the gland.

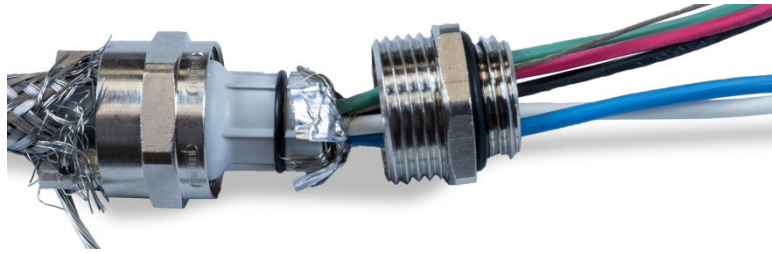

Figure A-55: Body of Gland Ready for Installation over Grommet

20. Hold the body of the gland still and screw the outer component onto it. Note that the plastic grommet is keyed and only fits into the body of the gland in specific positions. Pull back the exterior braided armor slightly to allow the outer component to rotate. This avoids twisting the shielding on the grommet. Note how the folded inner braided shield and foil are held tight against the body of the gland.

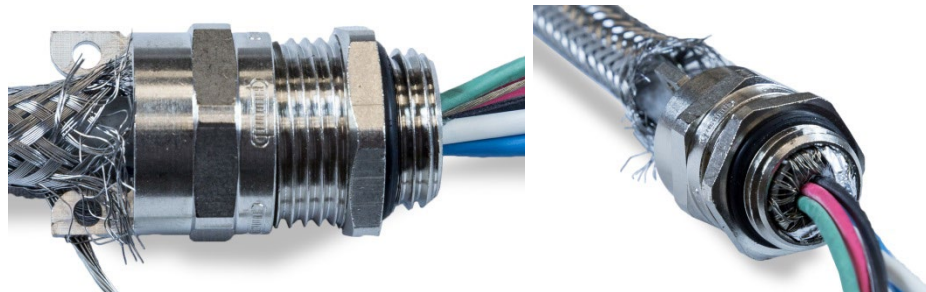

Figure A-56: Body of Gland Installed

21. Hold the body with a 20 mm wrench and use another 20 mm wrench to tighten the outer sealing part of the gland to 40 lb/in (5 Nm).
22. Push and slide the exterior braided armor up the cable so that its cut end is tight against the cable gland. Tidy up any stray wires by cutting and removing them.
23. Install the clamp disassembled in step 11. Tighten the screws evenly so that the clamps tighten symmetrically on the exterior braided armor. Note that the outer drain wire should emerge between the clamp and the cable gland.
24. Twist the green and black POWERCELL cable wires together with the internal drain wire, and crimp on one of the included ring terminals.

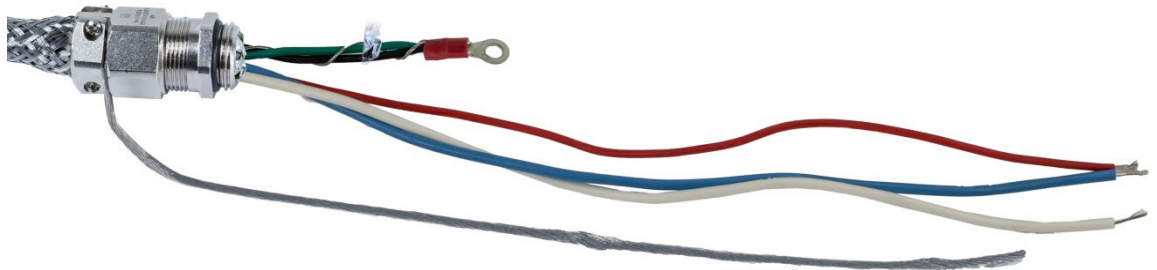

Figure A-57: Green and Black Wires with Internal Drain Wire

25. Feed the cables, except for the outer drain wire, into the enclosure through the opening from which the cable gland was removed.
26. Inside the enclosure, slide the nut removed in step 12 over the wires. Position the body of the cable gland in the opening, then install and tighten the nut to 40 lb/in (5 Nm).



Figure A-58: Cable Gland Nut Installed

27. The cable is now ready for connection and grounding.
28. Fasten the outer drain wire to the enclosure using the screw at the external grounding point indicated below.



Figure A-59: Grounding Clamp Location on Harsh Enclosure

A.3.6.4.3. Internal Cable Connection and Grounding

Figure A-60 and Table A-9 show the terminal definitions on the POWERCELL load cell terminal strip.

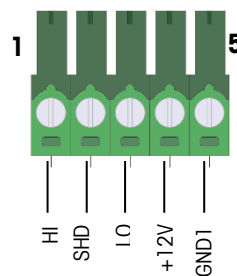

Figure A-60: POWERCELL Load Cell Termination

Table A-9: POWERCELL Cable Wire Signal Definition

No.	Definition	Description	PowerMount Homerun Cable Wire Color
1	HI	CAN High	White
2	SHD	Shield wire	Silver
3	LO	CAN Low	Blue
4	+12V	DC power supply to LCs	Red
5	GND1	Ground wire	Black

A.3.6.4.3.1. DIN or Panel Mount Enclosure

When connecting the POWERCELL PDX Homerun cable, shown in Figure A-48, the outer drain wire should be connected to the shield point of the cabinet where IND360 DIN or Panel-Mount installed. The inner drain wire should be connected to the SHD terminal in Figure A-40. Other wires should be connected as per Table A-9.

A.3.6.4.4. PowerMount Weigh Module Cabling

Figure A-61 shows the PowerMount Weigh Module Homerun cable. Please refer to Table A-9 for the wire coloring and signal mapping.

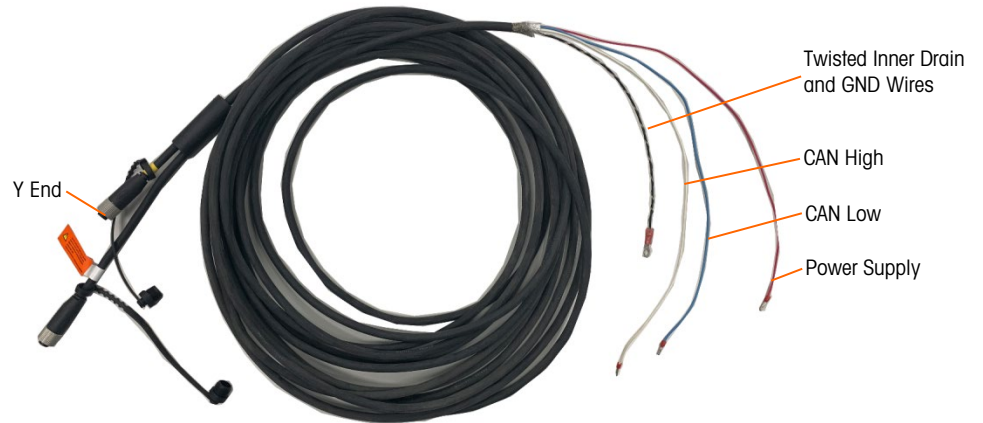

Figure A-61: PowerMount Homerun Cable

A.3.6.4.5. Harsh Enclosure

Ground and shield terminations are a critical part of the PowerMount system’s immunity to noise and electrical surges. Prepare and install the indicator end of the PowerMount cable as follows:

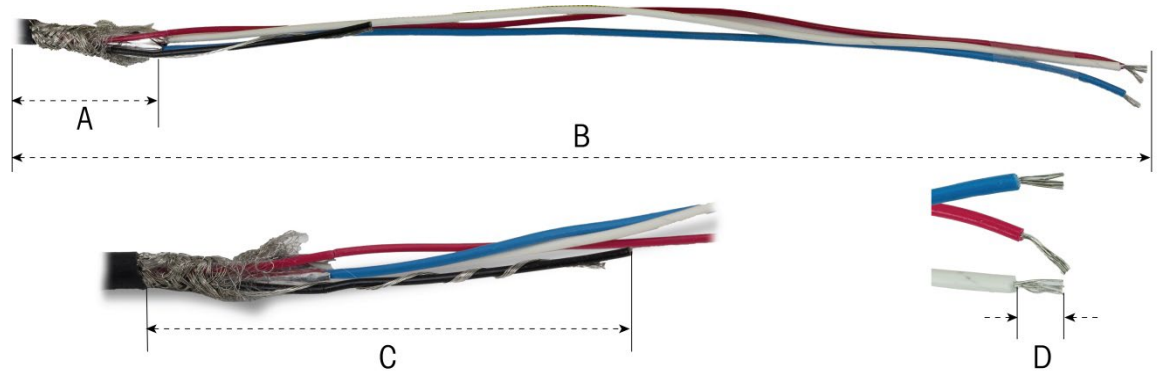

Figure A-62: Cable Preparation Measurements

Table A-10: Cable Preparation Lengths – Harsh

Letter	Description	Length
A	Length of inner braided shield	32 mm (1.25")
B	Length of red, white and blue wires	254 mm (10")
C	Length of black wire and drain wire	32 mm (1.25")
D	Amount of insulation to strip from wires	5 mm (0.2")

1. Remove the inner plastic grommet of the gland from the indicator enclosure.



Figure A-63: PowerMount Cable Gland Clamp and Grommet Disassembled

2. Slide the outer part of the gland and the plastic grommet down the cable. Fit the grommet into the gland. Position the plastic grommet so the end of it aligns with the end of the cable jacket.



Figure A-64: Cable Gland Installed on Cable

3. Unbraid the individual strands of the inner braided shield. Fold the individual strands of the inner braided shield back over the grommet. The individual strands should be uniformly distributed around the outer surface of the grommet. Trim the strands so they cover the end of the plastic grommet but not the O-ring.



Figure A-65: Inner Shield Unbraided and Folded Back over Grommet

4. Take the black and drain wires and crimp on one of the included ring terminals.



Figure A-66: Ring Terminal Crimped to Black and Drain Wires

5. Feed the cables into the enclosure through the opening from which the cable gland was removed.

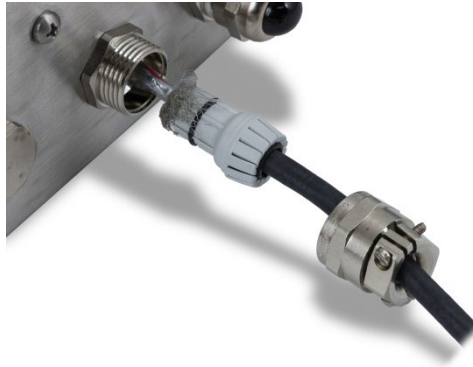

Figure A-67: Cables Entering Enclosure

6. Insert the grommet into the opening in the indicator, then screw on the gland clamp. Note that the plastic grommet is keyed so it only fits into the gland in specific positions. Tighten the clamp to 40 lb/in (5 Nm) to secure the cable.



Figure A-68: Cable Gland Installed

The cable is now ready for connection and grounding.

Cut off the ring terminal of the home run cable and connect its inner drain to the SHD terminal and the black GND wire to the GND1 terminal. Install the red, blue and white wires in the POWERCELL connector from the main board and tighten them in place. Plug the connector into the IND360 main board.

The installation is now complete.

A.3.6.4.5.1. DIN or Panel Mount Enclosure

When connecting the PowerMount Homerun cable, shown in Figure A-61, it is still necessary to cut off the ring terminal and connect the inner drain wire and black GND wire to the corresponding terminals of the connector on mainboard.

A.3.6.4.6. PowerDeck Connection

METTLER TOLEDO PowerDeck platforms use a M12 connector for indicators / transmitters for non hazardous area. (PowerDeck uses open wires for hazardous area.) In this case, use the cable shown below to convert the 5-pin connector of IND360 to a M12 connector, so that the PowerDeck platform can be easily connected without having to cut any wires. The cable is part of the delivery if option 5 is chosen in the SCK (see in chapter "Introduction").

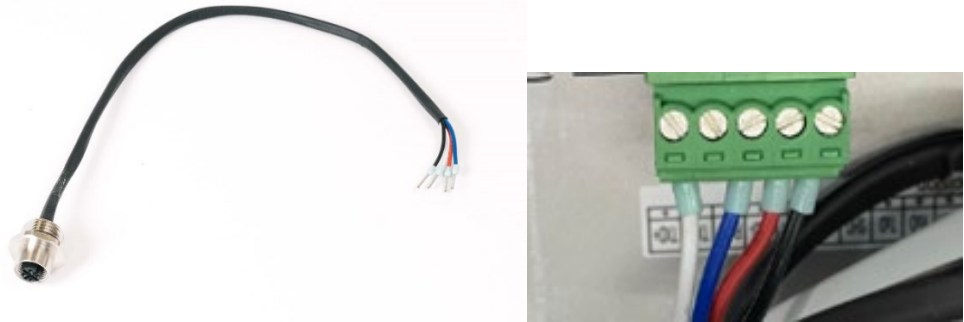





Figure A-69: M12 Cable for PowerDeck

The wiring information is shown below:

Table A-11: M12 Cable for PowerDeck Wire Signal Definition

No.	Definition	Description	Wire Colors
1	HI	CAN High	White 
2	SHD	Shield wire	Not connected
3	LO	CAN Low	Blue 
4	+12V	DC power supply to LCs	Red 
5	GND1	Ground wire	Black 

A.3.6.4.7. Maximum POWERCELL Cable Lengths

IND360POWERCELL is designed to power up to 8 POWERCELL load cells at a time. The maximum cable-to-cable length between load cells and home run cable length varies based on the load cell type and number of load cells used in the scale.

Table A-12 Maximum HR Cable Length with 3m cell-to-cell cable, SLC611D

		Number of SLC611D Load Cells		
		3	4	8
Home Run Cable Length	240m	246m		
	200m		209m	
	140m			
	100m			121m
	80m			
	60m			
	40m			
	20m			
	3m			
		6m	9m	21m
Length of Each cell-to-cell Cable: 3m				

Table A-13: Maximum HR Cable Length with 5m cell-to-cell cable, SLC611D

		Number of SLC611D Load Cells		
		3	4	8
Home Run Cable Length	210m	220m		
	165m		180m	
	100m			
	80m			115m
	50m			
	40m			
	20m			
	3m			
		10m	15m	35m
Length of Each cell-to-cell Cable: 5m				

Table A-14: Maximum HR Cable Length with 5m cell-to-cell cable, SLB615D

		Number of SLB615D Load Cells		
		4	6	8
Home Run Cable Length	150m	165m		
	100m		125m	
	70m			105m
		15m	25m	35m
Length of Each cell-to-cell Cable: 5m				

Table A-15: Maximum HR Cable Length with 10m cell-to-cell cable, SLB615D

		Number of SLB615D Load Cells		
		4	6	8
Home Run Cable Length	130m	160m		
	80m		130m	
	30m			100m
		30m	50m	70m
Length of Each cell-to-cell Cable: 10m				

Table A-16: Maximum HR Cable Length, SLC820

		Number of SLB615D Load Cells		
		4	6	8
Home Run Cable Length	300m	333m	355m	
	250m			323m
		33m	55m	73m
Total cell-to-cell cable length				

A.3.7. Wiring Connections for Options

IND360 indicator options that require external connections include the following:

- Option 1: (one of the following)
 - Analog Output
 - Digital Input/Output(5 In/8 Out)
 - Analog Output and Digital Input/Output (3 In/4 Out)
 - Digital Input/Output(4 In/4 Out), extended memory for Dynamic Application
- Option 2: (one of the following)
 - Industrial Ethernet connectivity(PROFINET, EtherNet/IP, EtherCAT, CC-Link IE Field Basic or Modbus TCP)
 - Industrial Ethernet (above) + IIoT (OPC UA)
 - PROFIBUS connectivity
 - Modbus RTU connectivity

Options are installed on the main PCB in the slots indicated in Figure A-70.

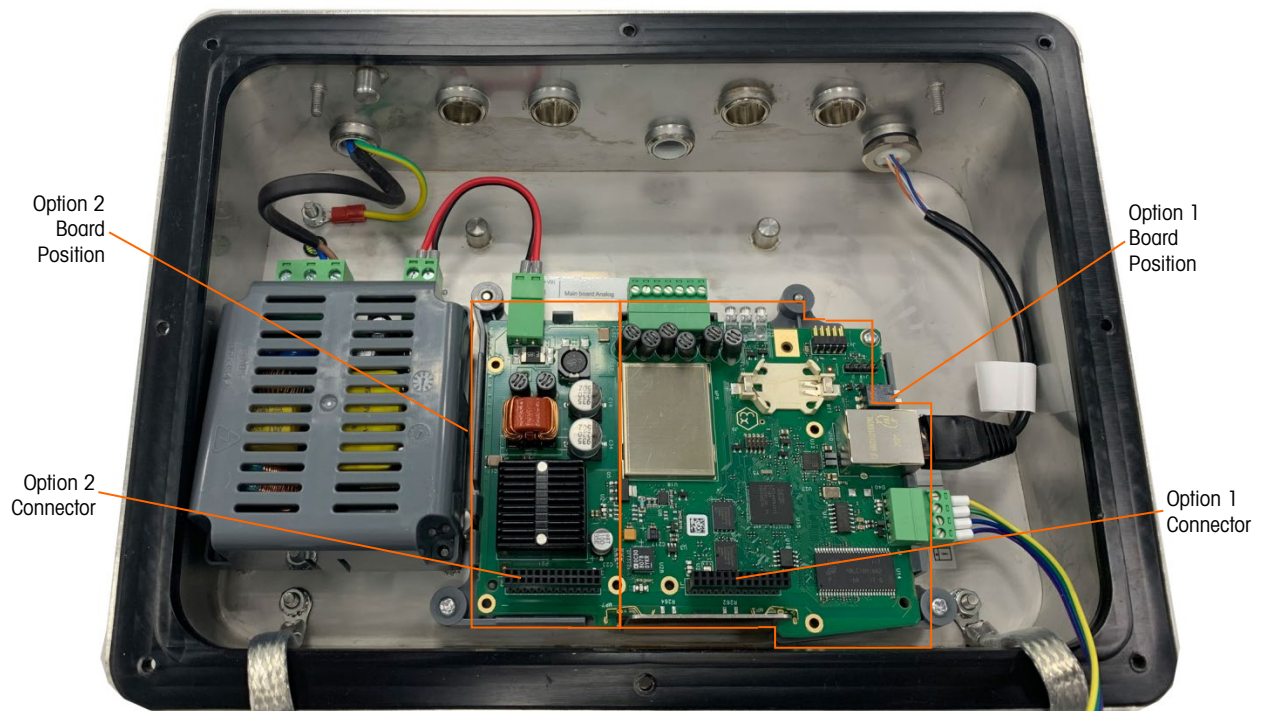

Figure A-70: Option Board Locations

A.3.7.1. Analog Output and DIO Option (3 Input/4 Output)

The Analog Output and DIO share the same option board shown in Figure A-71. Figure A-72 shows the option installed on the main board. This option provides a 4-20mA/0~10V analog signal proportional to the weight applied to the scale.

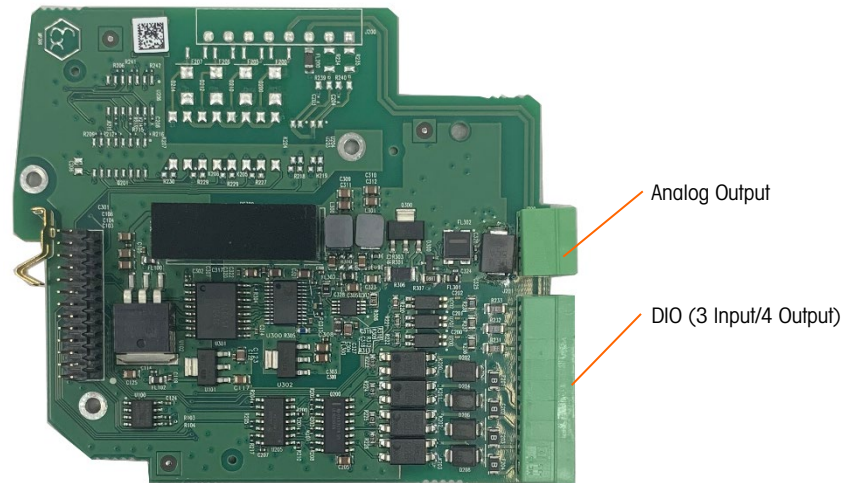

Figure A-71: Analog Output and DIO Option Board

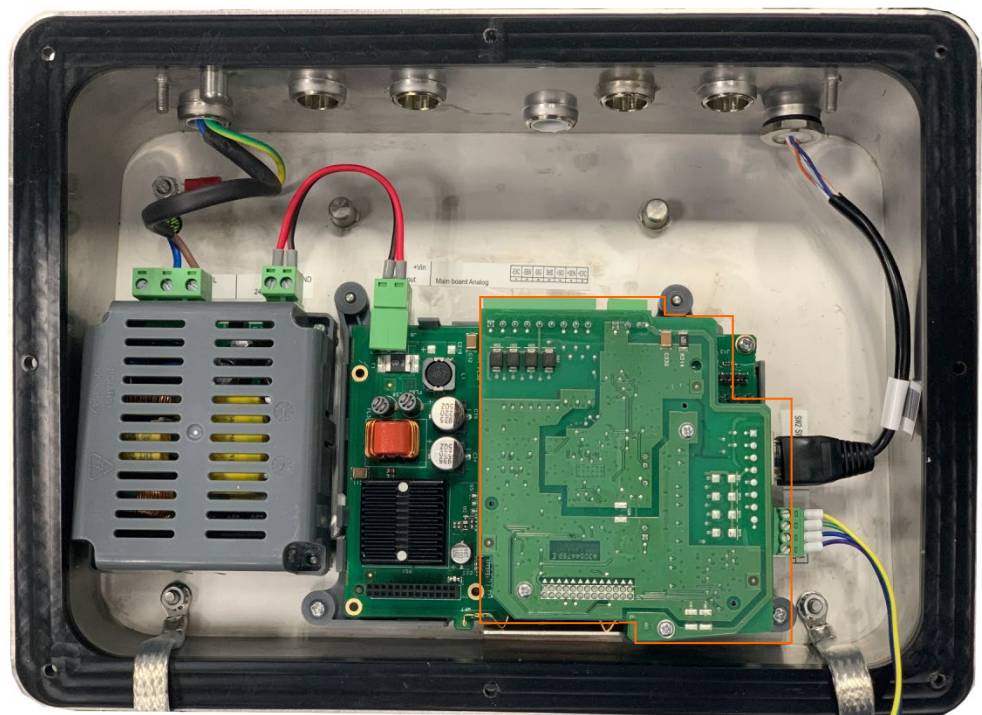

Figure A-72: Analog Output & DIO Option Board, Installed

Analog Output should be connected as shown in Figure A-73.

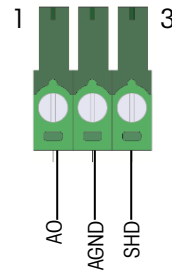

Figure A-73: Wiring to Analog Output Option

Table A-17 shows the digital input and output specifications.

Table A-17: Digital Inputs and Outputs Specification

	Input	Output
Permissible input voltage	0 ~ 24 VDC	5~30 VDC
Logical Low-level	0 ~ 3 VDC	
Logical High-level	5 ~ 30 VDC	5 ~ 30 VDC
Input resistance	>3KΩ	
Max. current of one output		150 mA
Accumulated current of all 4 outputs		600 mA
Sinking Connection	Voltage Source Common connected to ICOM	Voltage Source Common connected to OCOM
Sourcing Connection	Voltage Source connected to ICOM	Voltage Source connected to OCOM
Polarity Value	+True(Default) or -True	
Available Functionality	None, Clear Tare, Tare, Zero, Print	None, Center of Zero, Comparators (1-8), Smart5 Red, Smart5 Orange, Motion, Net, Over Capacity, Under Zero

DIO should be connected as shown in Figure A-74:

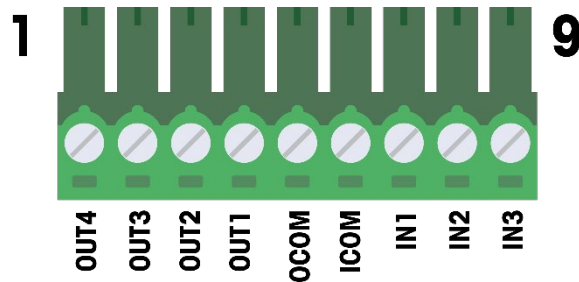

Figure A-74: Wiring to DIO Option

The DIO option supports both sinking and sourcing connection, the electrical connection instructions are shown below.

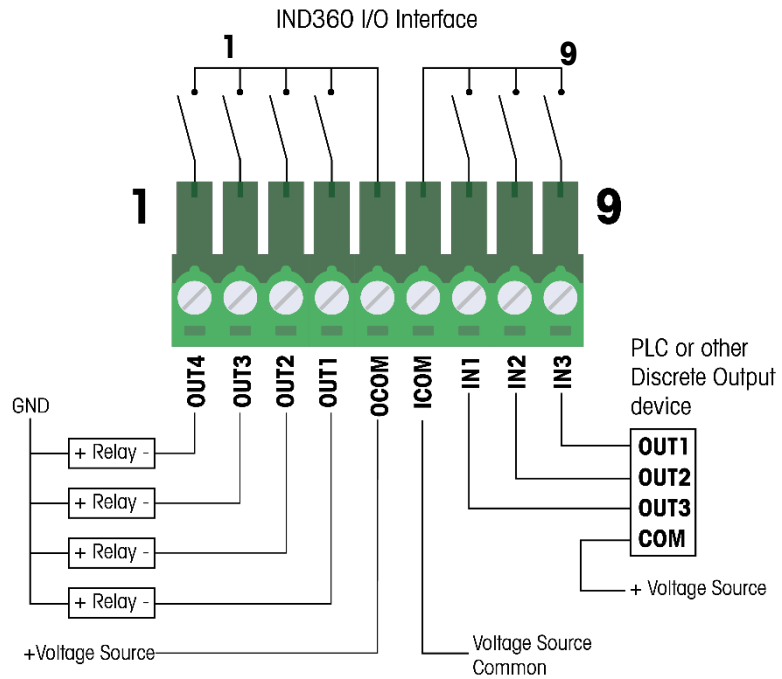

Figure A-75: Sinking Input and Sourcing Output

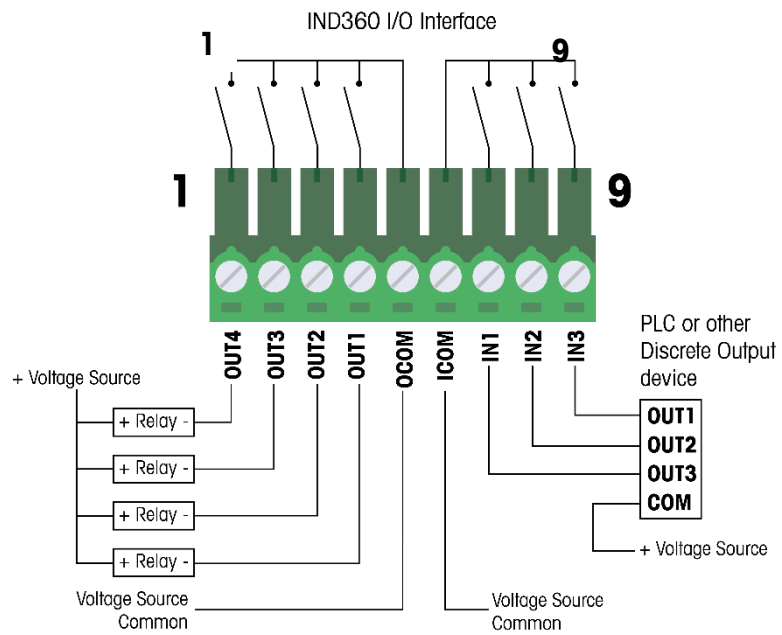

Figure A-76: Sinking Input and Sinking Output

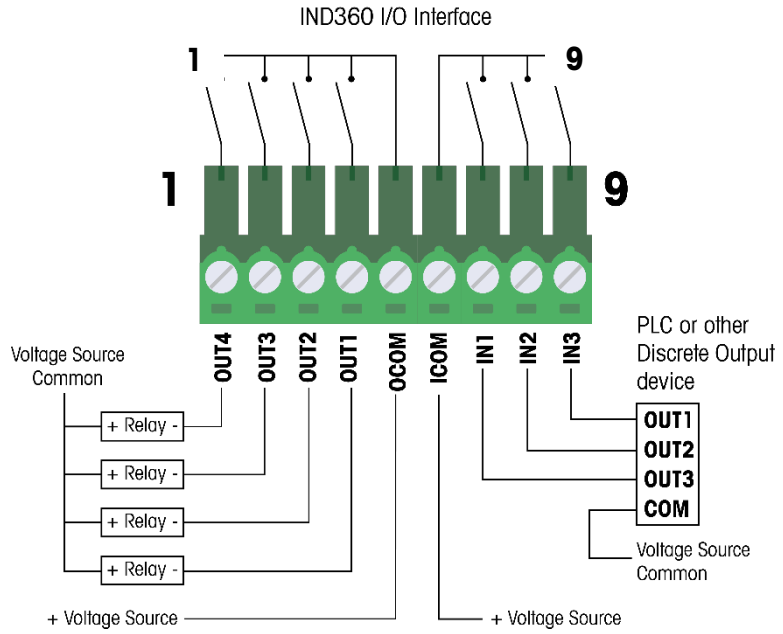

Figure A-77: Sourcing Input and Sourcing Output

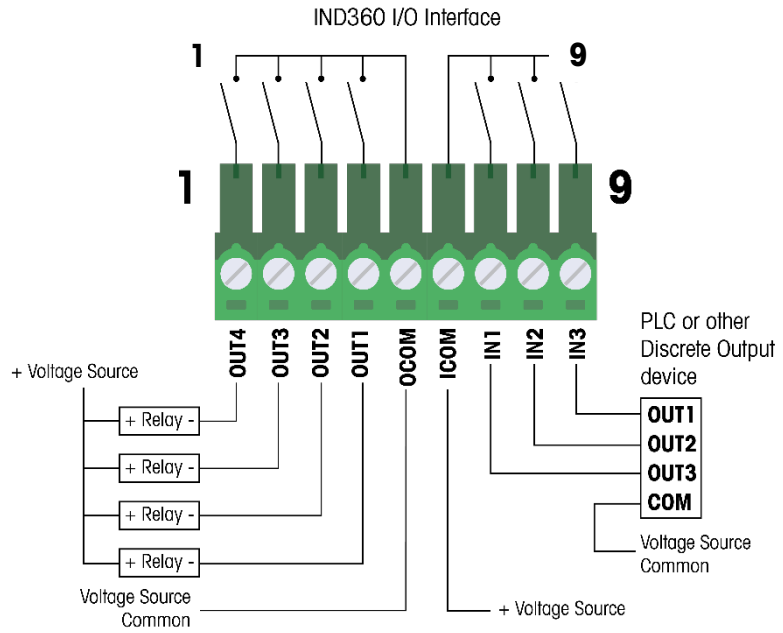

Figure A-78: Sourcing Input and Sinking Output

A.3.7.2. DIO Option (5 Input/8 Output)

The 5 Input/8 Output DIO option supports additional 2 inputs and 4 outputs compared to the Analog Output and DIO options. Refer to Figure A-75 to Figure A-78 for electronic connection.

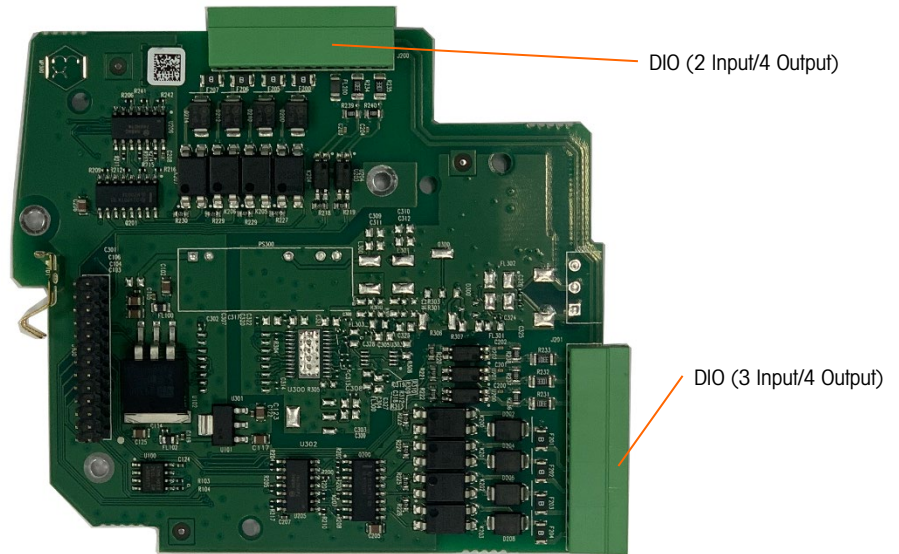

Figure A-79: DIO (5 Input/8 Output) Option Board

A.3.7.3. DIO Option (4 Input/4 Output), extended memory (for dynamic application)

This option has 4 digital input and 4 digital outputs. It has extended on-board memory, which allows storing more alibi memory when using dynamic application. Refer to Figure A-75 to Figure A-78 for electronic connection.

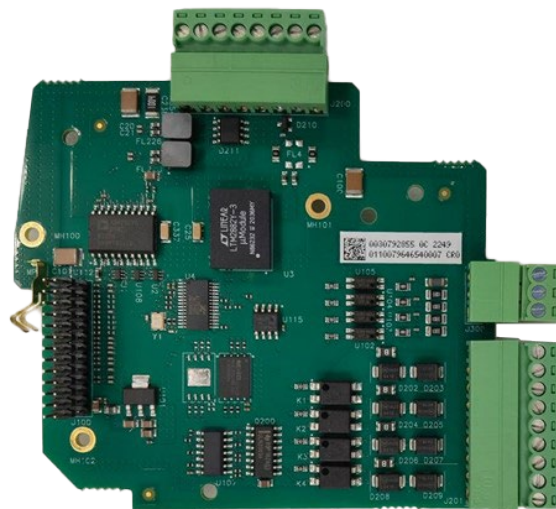

Figure A-80: DIO (4 Input/4 Output) extended memory Option Board

A.3.7.4. Industrial Ethernet Option, Industrial Ethernet + IIoT Option

The Industrial Ethernet option can be configured for PROFINET, EtherNet/IP, EtherCAT, CC-Link IE Field Basic or Modbus TCP. The dual RJ45 ports enable the Media Redundancy Protocol (MRP) or Device Level Ring (DLR). The Industrial Ethernet + IIoT option supports OPC UA

communication additionally. If you use PROFINET or EtherNet/IP, you can run OPC UA simultaneously.

The Industrial Ethernet option or Industrial Ethernet + IIoT option (Figure A-81) is installed in position 2 (Figure A-70) on the main board. To ensure communication reliability, please use Industrial Ethernet cables and connectors.



Figure A-81: Industrial Ethernet Option Board

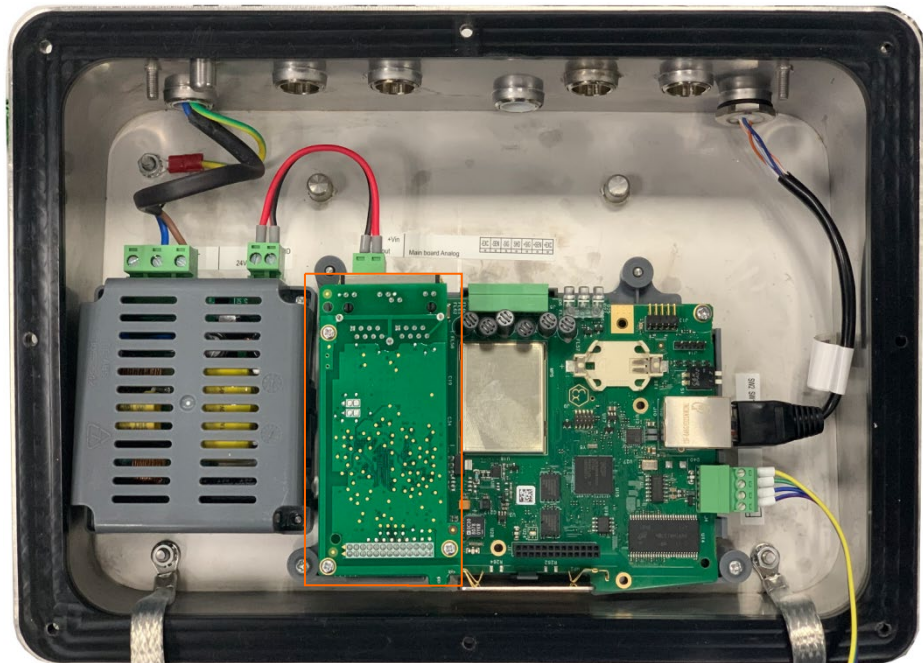

Figure A-82: Industrial Ethernet Option Board, Installed

When using EtherCAT, as shown in Figure A-83, X1.2 is the receiving port and X1.1 is the transmitting port.

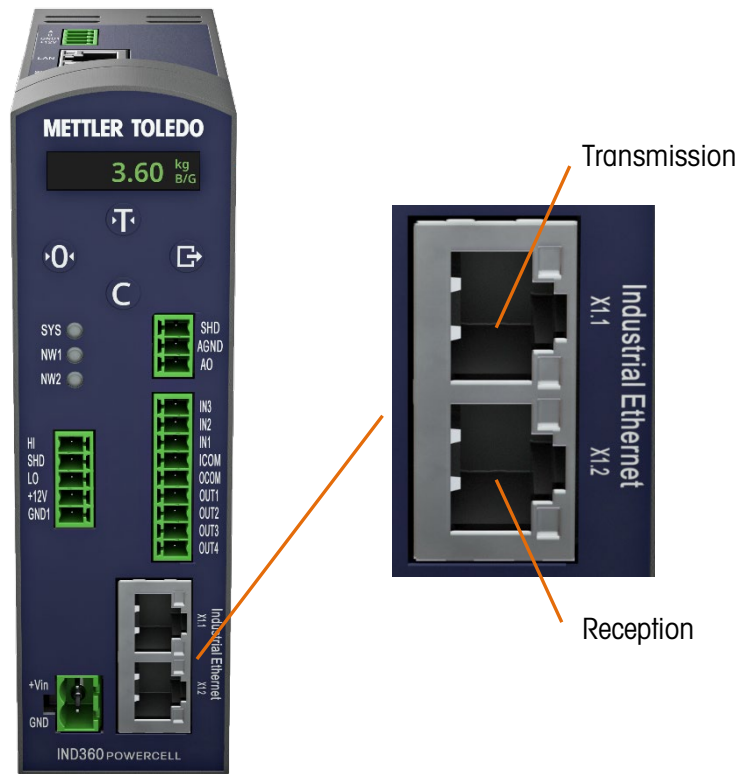

Figure A-83: EtherCAT Connections

A.3.7.5. PROFIBUS DP Option

The PROFIBUS DP option (Figure A-84) is installed in position 2 (Figure A-70) on the main board.

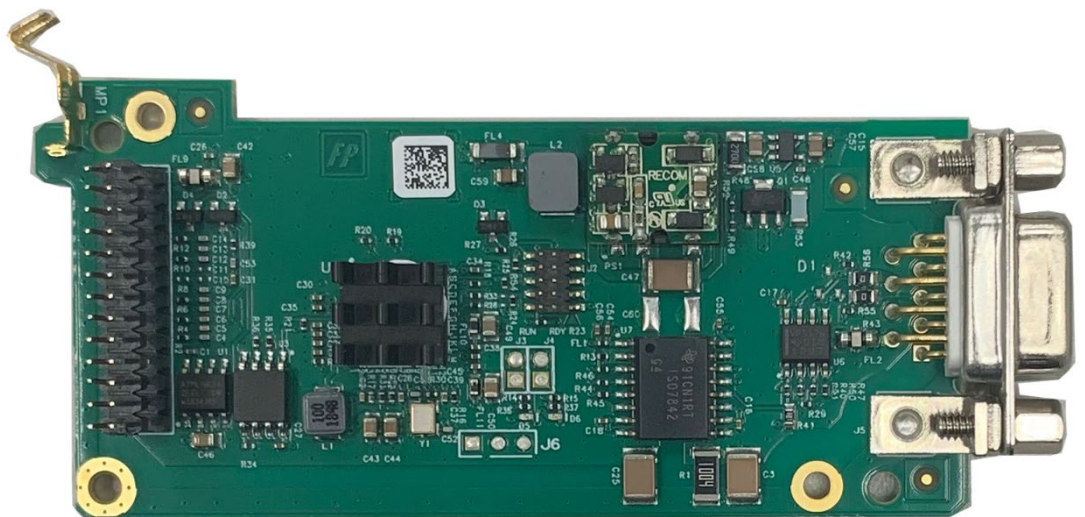

Figure A-84: PROFIBUS DP Option Board

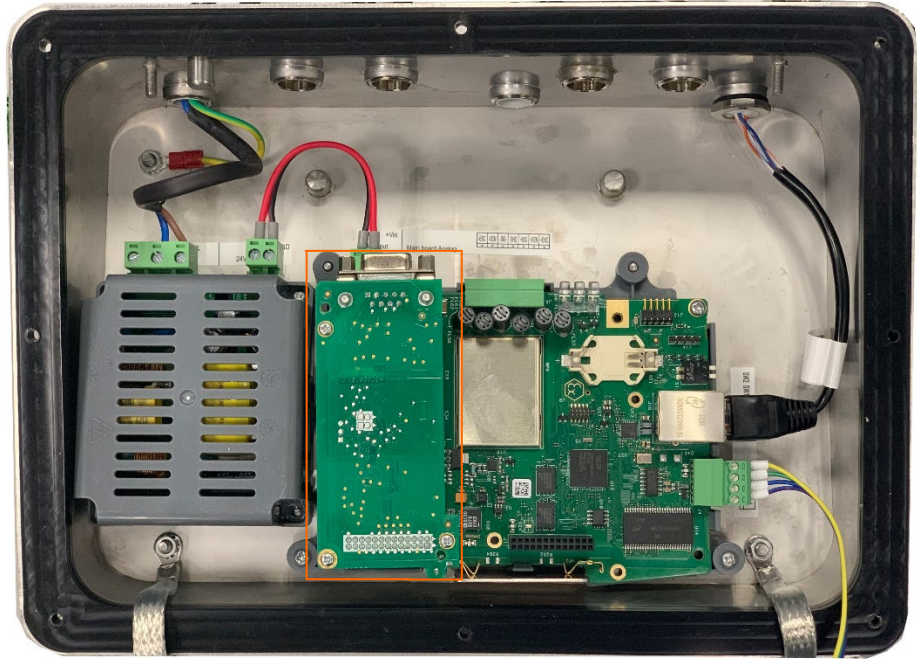

Figure A-85: PROFIBUS DP Option Board, Installed

A.3.7.6. Modbus RTU Option

The Modbus RTU option board (Figure A-86) is installed in position 2 (Figure A-70) on the main board.

To simplify wiring, IND360 provides two groups of RS485 A and B wires which are equivalent. They can be used to connect to last or next IND360 Indicators, as shown in Figure A-87 and Table A-18.

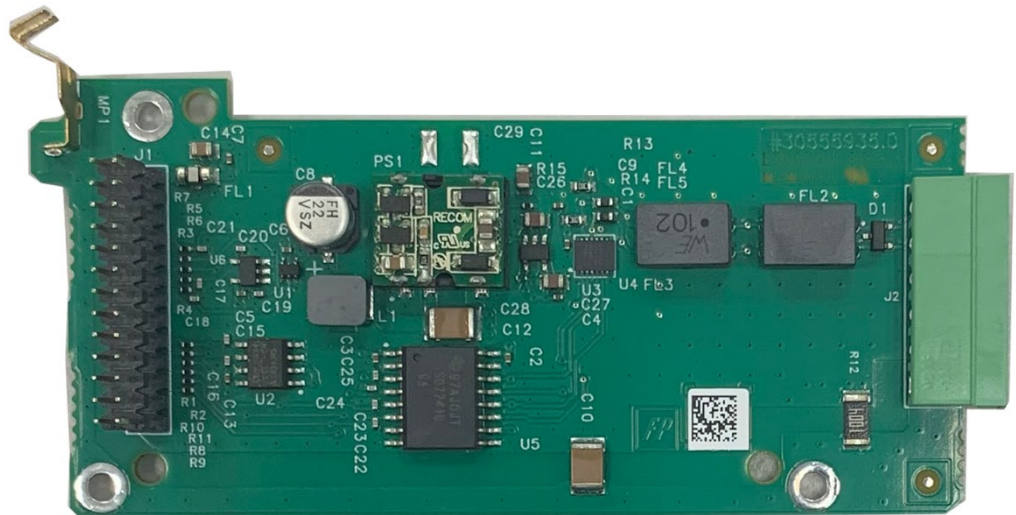

Figure A-86: Modbus RTU Option Board

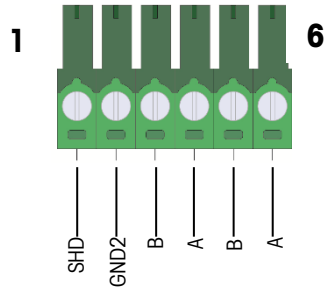

Figure A-87: Modbus RTU Option Signal

Table A-18: Modbus RTU Signal Definition

Pin No.	Signal Definition	Description	
1	SHD	The Shield of Modbus RTU cable	
2	GND2	Ground	
3	B	RS485 B	Connect to last(next) IND360 Indicator with Modbus RTU option
4	A	RS485 A	
5	B	RS485 B	Connect to next(last) IND360 Indicator with Modbus RTU option
6	A	RS485 A	

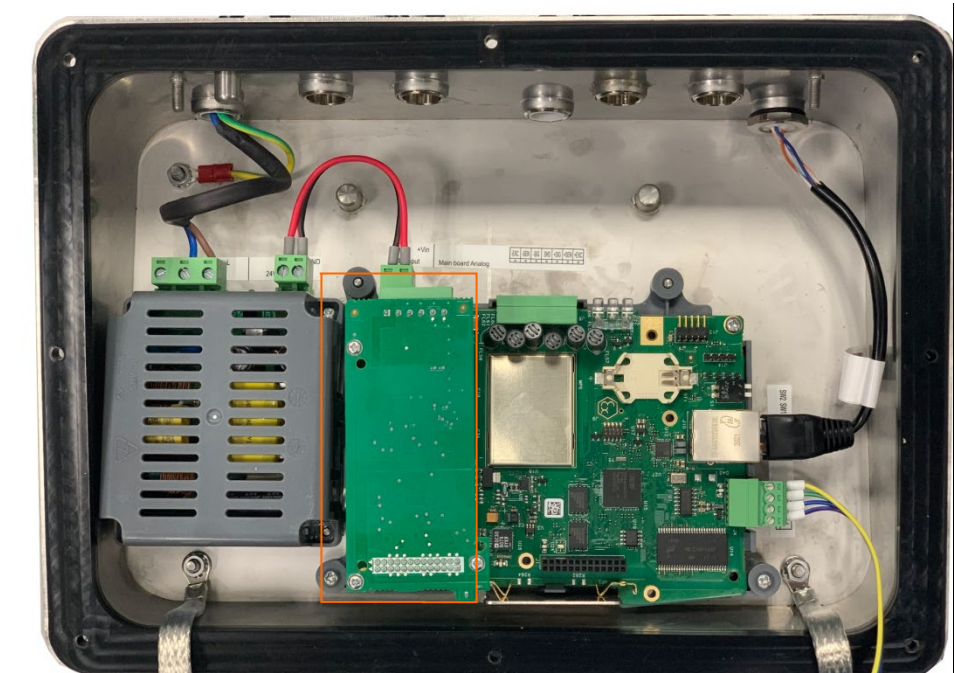

Figure A-88: Modbus RTU Option Board, Installed

A.4. PCB Switch Settings

This section describes switch settings for the main PCB.

A.4.1. Main PCB Switches

Two switches (indicated in Figure A-89, which shows the Analog version of the indicator) are located on the main PCB. They are visible on top of the DIN or Panel-Mount enclosure, or at the right of Harsh enclosure

These switches function as shown in Table A-19.

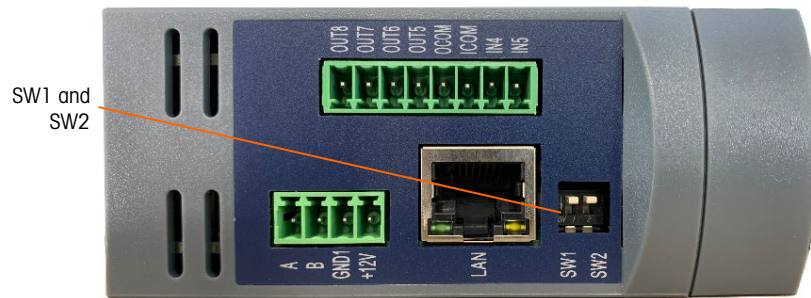

Figure A-89: SW1 and SW2 – DIN or Panel-Mount Models

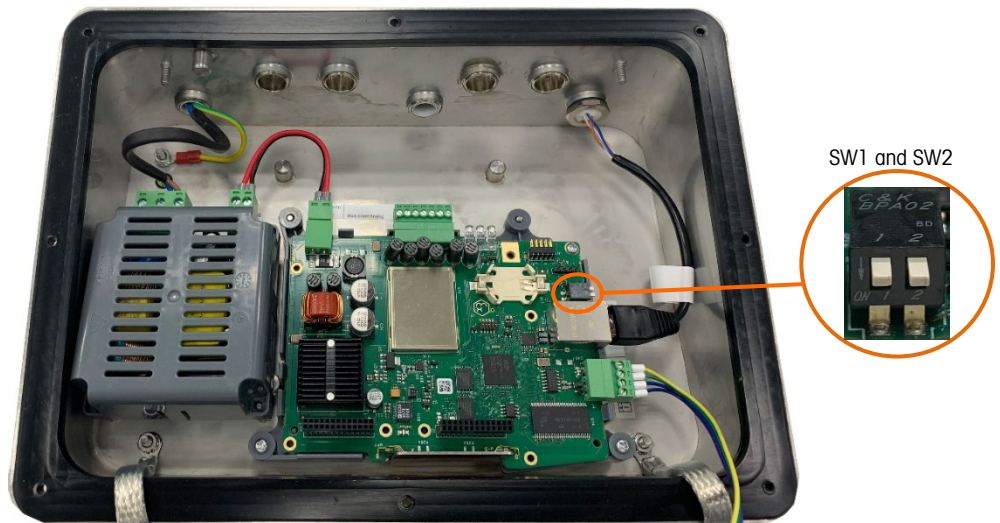

Figure A-90: Main PCB Switches

Table A-19: Functions of Main PCB Switches

Switch	Functions	
SW1	<p>Metrology Security Switch (legal for trade).</p> <p>When in the ON position, this switch reduces Administrator access to Maintenance level which prohibits access to the Scale block in the menu tree and other metrologically significant areas. This is true even if no scale approval option is selected in setup.</p> <p>Unless the application is specifically listed as legal for trade do not switch this to the "on" position.</p>	<p>When both SW1 and SW2 are set to ON and power is cycled, a Master Reset is performed. Metrologically significant data are not reset unless SW1 is also set to OFF.</p>
SW2	<p>Master reset.</p> <p>When in the ON position, IND360 will prompt message to ask for confirmation to reset parameters to default during powers up.</p>	

- When both SW1 and SW2 positioned ON and AC power is applied to the indicator, a Master Reset function will be initiated. This procedure will erase all programming in the indicator and return all settings back to factory default values. This process is described in Chapter 4, Service and Maintenance.

B. Default Settings

B.1. Default Parameter Settings

The following tables list the factory default settings of the IND360.

- Not all settings are available for all scale types. Parameters listed with dashes (--) are not available for that scale type.
- Not all settings are available on the local display.

Table B-1: Default Parameter Settings –Scale

Setup Feature	Default Value			
	Analog Scale	APW Precision Scale	SICSpro Scale	POWERCELL Scale
Scale - Type				
Name	[blank]	[blank]	--	[blank]
Scale Type	Analog	Precision	--	POWERCELL
LC Type	[Unknown]	--	--	--
Active LCs	1	--	--	1
Dummy LCs	--	--	--	0
Approval	Not Approval	(based on weigh module)	(based on weigh module)	Not Approval
Class	III	(based on weigh module)	(based on weigh module)	III
Scale – Advanced Setup Mode				
Advanced Setup Mode (ASM) is only for the SICSpro type scales. Settings such as Capacity, Increment, Zero, Tare, Filtering and Calibration are found within ASM.				
Scale – Load Cell – Single Address				
Find Cell	--	--	--	(operate button)
Serial Number	--	--	--	[blank]

Setup Feature	Default Value			
Node ID	--	--	--	[blank]
Scale – Load Cell – Manual Address				
Discovery Cells	--	--	--	(operate button)
Serial Number (1...8)	--	--	--	[blank]
Node ID (1...8)	--	--	--	[blank]
Scale – Load Cell – Shift adjust scale ("Shift Adjust" on OLED display of DIN version)				
Shift Adjust By	--	--	--	Cell
Shift Adjust	--	--	--	(operate button)
Scale – Load Cell – Single adjust by cell/pair ("Shift adj single" on OLED display of DIN version)				
Shift Adjust By	--	--	--	Cell
Adjust Cell/Pair				[blank]
Shift Adjustment	--	--	--	(operate button)
Scale – Capacity & Increment				
Primary Units	kg	--	--	kg
Capacity	60 kg	(read only based on weigh module)	(read only based on weigh module)	60 kg
Increment	0.02 kg	--	--	0.02 kg
Blank Over Capacity	99 d [disabled]	--	--	99 d [disabled]
Units	--	(based on weigh module)	(based on weigh module)	--
Readability	--	(based on weigh module)	(based on weigh module)	--

Setup Feature	Default Value			
Scale – Calibration				
Geo Code	20	--	--	20
Linearity Adjustment	None	--	--	None
Calibration Unit	kg	--	--	kg
Scale – Calibration - Zero Adjust				
Zero Adjust Procedure	(operate button)	--	--	(operate button)
Scale – Calibration - Span Adjust				
TestLoad1	[blank]	--	--	[blank]
TestLoad2	[blank]	--	--	[blank]
TestLoad3	[blank]	--	--	[blank]
TestLoad4	[blank]	--	--	[blank]
Span Adjust	(operate button)	--	--	(operate button)
Scale – Calibration - Step Calibration				
Test Load	[blank]	--	--	[blank]
Step Adjust	(operate button)	--	--	(operate button)
Scale – Calibration - CalFree				
Cell Capacity	0 kg	--	--	--
Cell Unit	kg	--	--	--
Rated cell output	3 mV/V	--	--	--
CalFree Calibration Procedure	(operate button)	--	--	--
Scale – Calibration - CalFree Plus				
CalFree Plus Calibration	--	--	--	(operate button)

Setup Feature	Default Value			
Scale – Calibration - Test				
Mode	--	[blank]	[blank]	--
Weight	--	[blank]	[blank]	--
Start Test	--	(operate button)	(operate button)	--
Scale – Calibration - Adjustment				
Mode	--	[blank]	[blank]	--
Step control	--	[blank]	[blank]	--
Weight	--	[blank]	[blank]	--
Start Adjustment	--	(operate button)	(operate button)	--
Scale – Zero - AZM&Display				
Auto Zero	Disable	--	--	Disable
Auto Zero Range	5 d	--	--	5 d
Under Zero Blanking	20 d	--	--	20 d
Scale – Zero - Ranges				
Power up Zero	Use Calibrated	--	--	Use Calibrated
Power Up Positive Range	10 %	--	--	10 %
Power Up Negative Range	10 %	--	--	10 %
Pushbutton Zero	Enable	--	--	Enable
Pushbutton Zero Positive Range	2 %	--	--	2 %
Pushbutton Zero Negative Range	2 %	--	--	2 %
Scale – Tare				
Pushbutton Tare	Enable	--	--	Enable

Setup Feature	Default Value			
Preset Tare	Enable	--	--	Enable
Power up tare	Enable	--	--	Enable
Scale – Filter				
Weight Mode	Normal	--	--	--
Environment	Standard	(based on weigh module)	--	--
Limit Frequency	5 Hz	--	--	--
LowPass Filter	--	--	--	Very Light
Stability Filter	--	--	--	Disable
Cut-off Frequency	--	(based on weigh module)	--	--
Weighing Mode	--	(based on weigh module)	--	--
Scale – Stability				
Motion Range	5 d	--	--	5 d
No-motion Interval	3 s	--	--	3 s
Timeout	3 s	--	--	3 s
Scale – Reset				
Reset branch to factory defaults	(operate button)	(operate button)	(operate button)	(operate button)

Table B-2: Default Parameter Settings – Application

Setup Feature	Default Value
Application	
Alibi Memory	Disable
Application – Comparator 1-8	
Description	[blank]
Source	None
Operator	<
Latching	Non-latching

Setup Feature	Default Value
Unit	g
Limit	0
High Limit	0
Application – Discrete Input	
Input [1...5] Trigger	RisingEdge
Input [1...5] Fun	None
Application – Discrete Output	
DIO Out[1...8] Fun	None
Application – Reset	
Reset branch to factory defaults	(operate button)

Table B-3: Default Parameter Settings – Terminal

Setup Feature	Default Value
Terminal – Device	
Model	IND360 [Analog POWERCELL Precision]
Serial Number	[Read Only]
Terminal – Display	
ScreenSaver	5 minutes
Backlight Adjustment	100 (0 – 100)
Language	[Factory setting]
Date&Time	Enable
Terminal – Format Time &Date	
Time Format	24:MM:SS
Date Format	YYYY/MM/DD
Terminal – Set Time & Date	
Hour	[Current RTC value]
Minutes	[Current RTC value]
Day	[Current RTC value]
Month	[Current RTC value]
Year	[Current RTC value]
Terminal – Keypad	
Keypad	Keypad Enable
Terminal – Reset	
Reset branch to factory defaults	(operate button)

Table B-4: Default Parameter Settings – Communication

Setup Feature	Default Value
Communication – Access Security	
Web Server	Disable
PC Application	Disable
ePrint	Disable
Communication – Service Ethernet	
MAC Address	[Factory setting]
IP Address	192.168.0.8
Subnet Mask	255.255.255.0
Gateway Address	192.168.0.1
Communication – Port	
Web Server	80
PC Application	1026
ePrint	1025
Communication – Analog Output	
Output Type	4-20mA
Source	Gross Weight
Zero Value	0 kg
Full Scale Value	50 kg
Zero Adjustment	(operate button)
Span adjustment	(operate button)
Communication – RS232	
Mode	Continuous Output
Checksum	Disable
Baud rate	9600
Data bits	8
Flow control	None
Parity	None
Stopbit	1
Communication – RS4xx	
Mode	Continuous Output
Checksum	Disable
Type	RS422
Baud rate	9600
Data bits	8
Flow control	None
Parity	None

Setup Feature	Default Value
Stopbit	1
Communication – Modbus RTU	
Buad Rate	9600
Data Bits	8
Flow Control	OFF
Parity	None
Node Address	0
Byte Order	None
Supervision	Disable
Timeout	3s
Communication – PROFIBUS DP	
Node Address	2
Format	2
Byte Order	Automatic
Supervision	Enable
Communication – Industrial Ethernet	
Type	None
Format	2
Byte Order	Automatic
Supervision	Enable
IP Address	192.168.0.2
MAC Address	[Factory setting]
Subnet Mask	255.255.000.000
Gateway Address	192.168.000.001
Device Name (PROFINET only)	[blank]
DHCP (EtherNet/IP only)	Disable
Device ID(EtherCAT only)	0
Industrial ethernet firmware version (IIOT only)	[Factory setting]
OPC UA port (IIOT only)	4840
OPC UA current session number (IIOT only)	[Read Only]
OPC UA firmware version (IIOT only)	[Factory setting]
Communication – Reset	
Reset branch to factory defaults	(operate button)

Table B-5: Default Parameter Settings – Maintenance

Setup Feature	Default Value			
	Analog Scale	APW Precision Scale	SICSpro Scale	POWERCELL Scale
Maintenance – Configure/View – Change Log				
Enable/Disable	Disable	Disable	Disable	Disable
Reset	(operate button)	(operate button)	(operate button)	(operate button)
Maintenance – Configure/View – Maintenance Log				
Enable/Disable	Enable	Enable	Enable	Enable
Reset	(operate button)	(operate button)	(operate button)	(operate button)
Maintenance – Configure/View – Error Log				
Enable/Disable	Enable	Enable	Enable	Enable
Reset	(operate button)	(operate button)	(operate button)	(operate button)
Maintenance – Configure/View – Smart5				
Customer under/overload	Enable	--	--	Enable
Over Load	20 %	--	--	20 %
Under Load	20 %	--	--	20 %
Maintenance – Configure/View – RunFlat				
Off/Automatic	--	--	--	Off
Temperature Trigger	--	--	--	Disable
Clear overload Flag	--	--	--	(operate button)
Maintenance – Configure/View – Reset				
Reset branch to factory defaults	(operate button)	(operate button)	(operate button)	(operate button)
Maintenance – Run – Terminal				
Load cell output	[Read Only]	--	--	[Read Only]
supply voltage	--	[Read Only]	[Read Only]	[Read Only]
supply current	[Read Only]	[Read Only]	[Read Only]	[Read Only]
Maintenance – Run – Calibration Values				
Zero Counts	0	--	--	0
Xlow calib.wt Weight	25g	--	--	25 g
Xlow calib.wt Counts	0	--	--	0

Setup Feature	Default Value			
Low calib.wt Weight	25 g	--	--	25 g
Low calib.wt Counts	0	--	--	0
Mid calib.wt Weight	25 g	--	--	25 g
Mid calib.wt Counts	0	--	--	0
High calib.wt Weight	60 g	--	--	60 g
High calib.wt Counts	6'000'000	--	--	6'000'000
Mid hyst.wt Counts	--	--	--	0
Low hyst.wt Counts	--	--	--	0
Xlow hyst.wt Counts	--	--	--	0
RESET	(operate button)	--	--	(operate button)
SET	(operate button)	--	--	(operate button)
Maintenance – Run – Calibration History				
Index	--	--	--	[Read Only]
Date&Time	--	--	--	[Read Only]
Zero	--	--	--	[Read Only]
Xlow calib.wt	--	--	--	[Read Only]
Low calib.wt	--	--	--	[Read Only]
Mid calib.wt	--	--	--	[Read Only]
High calib.wt	--	--	--	[Read Only]
Mid hyst.wt	--	--	--	[Read Only]
Low hyst.wt	--	--	--	[Read Only]
Xlow hyst.wt	--	--	--	[Read Only]
Clear	--	--	--	(operate button)
Prev	--	--	--	(operate button)
Next	--	--	--	(operate button)
Maintenance – Run – Statistics				
Weighments	[Read Only]	--	--	[Read Only]
Overloads	[Read Only]	--	--	[Read Only]
Zero Commands	[Read Only]	--	--	[Read Only]

Setup Feature	Default Value			
Zero Failures	[Read Only]	--	--	[Read Only]
Maintenance – Run – Shift Adjust Values				
Node1...x	--	--	--	[blank]
SET	--	--	--	(operate button)
Maintenance – Run – Restore PowerDeck Scale Data				
START	--	--	--	(operate button)
ESC	--	--	--	(operate button)
Maintenance – Run – POWERCELL 1...x				
S/N	--	--	--	[Read Only]
SW version	--	--	--	[Read Only]
Temperature	--	--	--	[Read Only]
Load cell output	--	--	--	[Read Only]
Supply voltage	--	--	--	[Read Only]
Gas	--	--	--	[Read Only]
Maintenance – Run – POWERCELL Statistic				
S/N	--	--	--	[Read Only]
Operate Range Overload	--	--	--	[Read Only]
Normal Range Overload	--	--	--	[Read Only]
Maintenance – Error Message				
No.	[Read Only]	[Read Only]	[Read Only]	[Read Only]
Alarm ID	[Read Only]	[Read Only]	[Read Only]	[Read Only]
Description	[Read Only]	[Read Only]	[Read Only]	[Read Only]
Action	[Read Only]	[Read Only]	[Read Only]	[Read Only]
Maintenance –Update & Backup – Firmware				
Choose Firmware	(operate button)	(operate button)	(operate button)	(operate button)
Update	(operate button)	(operate button)	(operate button)	(operate button)
Maintenance –Update & Backup – Configuration				
Choose File	(operate button)	(operate button)	(operate button)	(operate button)
Restore	(operate button)	(operate button)	(operate button)	(operate button)

Setup Feature	Default Value			
Backup	(operate button)	(operate button)	(operate button)	(operate button)
Overwrite adjustment parameters	No	No	No	No
Maintenance – Update & Backup – License request code				
Application license type	None	None	None	None
Connectivity license type	None	None	None	None
Activation ID	[Read Only]	[Read Only]	[Read Only]	[Read Only]
Maintenance – Update & Backup – License activation				
Activation code	[Empty]	[Empty]	[Empty]	[Empty]
Maintenance – Weight Simulator – Simulator Switch				
Set	(operate button)	(operate button)	(operate button)	(operate button)
Switch	Disable	Disable	Disable	Disable
Maintenance – Weight Simulator – Simulator				
Weight input	[blank]	[blank]	[blank]	[blank]
Gross	[Read Only]	[Read Only]	[Read Only]	[Read Only]
Maintenance – Weight Simulator – Precision Scale Parameter				
Primary units	--	(based on weigh module)	(based on weigh module)	--
Capacity	--	(based on weigh module)	(based on weigh module)	--
Increment	--	(based on weigh module)	(based on weigh module)	--
Blank Over Capacity	--	(based on weigh module)	(based on weigh module)	--
Under Zero Blanking	--	(based on weigh module)	(based on weigh module)	--
Maintenance – Reset All				
Reset all branches to factory defaults	(operate button)	(operate button)	(operate button)	(operate button)

C. TCP/IP Communication

Use the service interface (TCP/IP) port to establish a socket communication between an IND360 and an external device such as PC. This communication enables the following operations using the MT-SICS protocol:

- Request weighing results such as Gross, Tare and Net values,
- Operate Zero, Tare and Clear commands remotely,
- Read the device's Serial Number and FW Revision Number.

C.1. Socket Connection

If the SICS communication is enabled (**Communication > Access Security > PC Application** set to Enable), the user can connect to the IND360 via its IP address. The default port for SICS communication is 1026. Only one socket connection is allowed.

C.2. Introduction to MT-SICS Command

MT-SICS (METTLER TOLEDO Standard Interface Command Set) is a standardized command set by METTLER TOLEDO. Only the MT-SICS commands listed in Table C-1 are supported by IND360.

Table C-1: IND360 MT-SICS Command List

No	Command	Description
1	SIX1	Provide complete weight information to host software, several status flags beside gross, net and tare value
2	TA	Request tare value
3	SI	Request net value
4	Z	Zero the scale.
5	ZI	Zero Immediately
6	T	Tare a stable weight value
7	TI	Tare Immediately
8	TAC	Clear tare value
9	I3	Inquiry of FW Revision Number
10	I4	Inquiry of Serial Number
11	I0	Inquiry of all implemented MT-SCIS commands
12	I2	Inquiry of Scale Data
13	S	Request stable weight value

C.2.1. Command Formats of MT-SICS

Each command received by IND360 is acknowledged by a response to the host. Commands and responses are data strings with a fixed format. Commands sent to the IND360 comprise one or more characters of the ASCII character set. Enter commands only in uppercase.

The parameters of the command must be separated from one another and from the command name by a space (ASCII 32 dec., in the examples shown in this section, a space is represented as _).

Each command must be terminated by CR LF (ASCII 13 dec., 10 dec.).

The characters CR and LF, which can be input using the ENTER or RETURN key of most entry keypads, are not listed in this description. However, it is essential they be included for communication with IND360.

C.2.1.1. SICS Command Example

Command to tare the IND360:

"TA _ 20.00 _ kg" (The command terminator CR LF is not shown.)

C.2.2. Response Formats

All responses sent by the IND360 indicator to acknowledge the received commands have one of the following formats:

- Response with weight value
- Response without weight value
- Error message

C.2.2.1. Format of the Response with Weight Value

A general description of the response with weight value as follows:

ID _ Status _ Weight Value _ Unit CR LF

Table C-2: Response Format

No	Response Characters	Description
1	ID	Response identification
2	_	Space (ASCII 32 dec.)
3	Status	Status of the IND360. Refer to the description of the commands and responses in the sections below
4	Weight Value	Weighing result, shown as a number with 10 digits, including sign directly in front of the first digit. The weight value appears right justified. Preceding zeroes are uppressed with the exception of the zero to the left of the decimal point.
5	Unit	Weight unit displayed
6	CR	Carriage Return (ASCII 13 dec.)
7	LF	Line Feed (ASCII 10 dec.)

C.2.3. Example

Response with a stable weight value of 0.256 kg:

S _ S _ _ _ _ _ 0.256 _ kg

Here CR LF is not shown.

C.2.3.1. Format of the Response without Weight Value

A general description of the response without weight value is as follows:

ID _ Status _ Paramters CR LF

Table C-3: Response Format Without Weight Value

No	Response Characters	Description
1	ID	Response identification
2	_	Space (ASCII 32 dec.)
3	Status	Status of the IND360. Refer to the description of the commands and responses in the sections below
4	Parameters	Command-dependent response code
5	CR	Carriage Return (ASCII 13 dec.)
6	LF	Line Feed (ASCII 10 dec.)

C.2.3.2. Error Messages

ID CR LF

Table C-4: Response Format

No	Response Characters	Description
1	ID	Response identification, could be ES – Syntax error: IND360 has not recognized the received command. ET – Transmission error: The scale has received a “faulty” command, such as a parity error. EL – Logical error: The command is understood, the parameter is incorrect. EI – Internal Error: The command is understood but cannot be executed at this time.
2	CR	Carriage Return (ASCII 13 dec.)
3	LF	Line Feed (ASCII 10 dec.)

C.3. SIX1 Command

C.3.1. Description

SIX1 is intended to provide complete weighing information for a variety of applications. To provide complete weight information to the indicator or host software, several status flags are provided beside gross, net and tare value.

C.3.2. Syntax

The Six1 command reads parameters from IND360.

Command:

SIX1

Response:

SIX1 Sts MinW CoZ Rep Calc PosE StepE MarkE Range TM G N T Unit

C.3.3. Parameters

Table C-5: Six1 Command Response

No	Response Characters	Description
1	Sts	Status of the weighing, linked to the net value {Data type: character; encoding ASCII; range of characters see below} The statuses can have the following states: S Stable weight D Dynamic weight (unstable, not accurate) + Overload - Underload I Invalid value, device not ready
2	MinW	Always 0
3	CoZ	Center of zero status {Data type: character; encoding ASCII; range of characters see below.} The center of zero status can have the following states: Z +/- ¼ d around gross zero. N Outside the limits of +/- ¼ d around gross zero
4	Rep	Repeating indicator {Data type: character; encoding ASCII; range of characters see below.} This field indicates, if the value has already been sent or if this is a new weight update (new computed weight value). Valid values are: R Repeated value (was already sent once or more times) N New weight update (new computed weight value)
5	Calc	Always R
6	PosE	Always 0
7	StepE	Always 0

No	Response Characters	Description
8	MarkE	Always 0
9	Range	Always 1
10	TM	Tare mode (no tare, manual tare, measured tare). {Data type: character; encoding ASCII; range of characters see below} Tare modes are: N no tare M measured tare P preset tare
11	G	Gross value
12	N	Net value
13	T	Tare value
14	Unit	The displayed unit

C.3.4. Example

Command: SIX1

Response: SIX1 S 0 Z N R 0 0 0 1 N 0.00 0.00 0.00 kg

C.4. TA Command

C.4.1. Description

The TA command is used to inquire of tare weight value

C.4.2. Syntax

Command:

TA

Response:

TA _ A _ TareWeightValue _ Unit to report current Tare weight value.

TA _ I – The command is understood but cannot be executed at this time

TA _ L – Command understood, parameter wrong.

C.4.3. Example

Command:

TA

Response:

TA _ A _ _ _ _ 10.00 _ kg

C.5. S Command

Command: S – Send the current stable weight.

Response:

S _ S _ WeightValue _ Unit – Current stable weight value in current displayed units

S _ I –The command is understood but cannot be executed at this time. (IND360 indicator is currently executing another command such as taring, or stability was not reached before timeout expired.)

S _ + – IND360 in overload range.

S _ - – IND360 in underload range.

Example

Command: S – Send a stable weight value.

Response: S _ S _ _ _ _ _ 100.00 _ kg. – The current, stable weight value is 100.00 kg.

- The indicator will wait for up to 30 seconds after receiving an “S” command for no-motion. If motion does not settle within this time, the command is aborted.

C.6. SI Command

C.6.1. Description

The SI command is used to inquire the net value.

C.6.2. Syntax

Command:

SI

Response:

S _ S _ WeightValue _ Unit – Stable weight value.

S _ D _ WeightValue _ Unit – Non-stable weight value.

S _ I – The command is understood but cannot be executed at this time.

S _ + – IND360 in overload range.

S _ - – IND360 in underload range.

C.6.3. Example

Command:

SI

Response:

S _ D _ _ _ _ _ 129.07 _ kg

C.7. Z Command

C.7.1. Description

The Z command is used to zero the scale.

C.7.2. Syntax

Command:

Z

Response:

Z _ A – Zero setting performed.

Z _ I – The command is understood but cannot be executed at this time

Z _ + – Upper limit of zero setting range exceeded.

Z _ - – Lower limit of zero setting range exceeded.

C.7.3. Example

Command:

Z

Response:

Z _ A

C.8. ZI Command

C.8.1. Description

The ZI command is used to zero the scale immediately.

C.8.2. Syntax

Command:

ZI

Response:

ZI _ A – Zero the scale successfully

ZI _ I – The command is understood but cannot be executed at this time

ZI _ + – Upper limit of zero range exceeded.

ZI _ - – Lower limit of zero range exceeded.

C.8.3. Example

Command:

ZI

Response:

ZI _ A

C.9. T Command

C.9.1. Description

The T command is used to tare a stable weight value.

C.9.2. Syntax

Command:

T

Response:

T _ S _ WeightValue _ Unit – Tare performed. Stability criterion and tare range comply with settings.

Current Tare weight value in current units is returned.

T _ I – Tare not performed

T _ + – Upper limit of tare range exceeded.

T _ - – Lower limit of tare range exceeded.

C.9.3. Example

Command:

T

Response:

T _ S _ _ _ _ _ 100.00 _ kg

C.10. TI Command

C.10.1. Description

The TI command is used to store the current gross value as tare, which can be stable or non-stable as tare weight value.

C.10.2. Syntax

Command:

TI

Response:

TI _ S _ Weight Value _ Unit – Tare performed, stable tare value.

TI _ D _ Weight Value _ Unit – Tare performed, non-stable tare value.

TI _ I – The command is understood but cannot be executed at this time.

TI _ L – The command is understood, the parameter is wrong.

TI _ + – Upper limit of tare range exceeded.

TI _ - – Lower limit of tare range exceeded.

C.10.3. Example

Command:

TI
Response:
TI _ D _ _ _ _ _ 117.57 _ kg

C.11. TAC Command

C.11.1. Description

The TAC command is used to clear tare value.

C.11.2. Syntax

Command:

TAC

Response:

TAC _ A – Tare value cleared.

TAC _ I – The command is understood but cannot be executed at this time

C.11.3. Example

Command:

TAC

Response:

TAC _ A

C.12. IO Command

C.12.1. Description

The IO command is used to inquire of all implemented MT-SICS commands

C.12.2. Syntax

Command:

IO

Response:

IO _ B _ x1 _ "1.Command" – x1 = MT-SICS level

IO _ B _ x1 _ "2.Command"

...

IO _ B _ x1 _ "Last Command"

IO _ I – The command is understood but cannot be executed at this time

C.12.3. Example

Command:

IO

Response:

```
IO/B/O/"IO" – level 0 command "IO" implemented
IO/B/O/"Z" – level 0 command "Z" implemented
...
IO/B/O/"TI" – level 1 command "TI" implemented
```

C.13. I2 Command

C.13.1. Description

The I2 command is used to inquire scale data

C.13.2. Syntax

Command:

```
I2
```

Response:

```
I2 _ A _ "text" – Scale data as "text"
I2 _ I - The command is understood but cannot be executed at this time
```

C.13.3. Example

Command:

```
I2
```

Response:

```
I2 _ A _ "RPA455 7500.0g"
```

C.14. I3 Command

C.14.1. Description

The I3 command is used to inquire of FW Revision Number.

C.14.2. Syntax

Command:

```
I3
```

Response:

```
I3 _ A _ "text" – Firmware Revision number as "text"
```

C.14.3. Example

Command:

```
I3
```

Response:

```
I3 _ A _ "1.05 _ 1.1.1.17.7"
```

C.15. I4 Command

C.15.1. Description

The I4 command is used to inquire of IND360 Serial Number.

C.15.2. Syntax

Command:

I4

Response:

I4 _ A _ "Text" – Serial number as "text"

C.15.3. Example

Command:

I4

Response:

I4 _ A _ "C123456789"

D. OPC UA Communication

The optional OPC UA communication allows users to access IND360 from an external device such as a PC and execute the following operations:

- Read weighing results such as Gross, Tare and Net values
- Operate Zero, Tare and Clear commands
- Read the device's Serial Number and FW Revision Number
- Monitor the device's status such as alarms and connection status

D.1. Establishing the Connection

D.1.1. Preparation on the IND360

Set the following parameters using the web interface (recommended) or directly on the display of IND360.

1. Enable OPC UA communication:
Communication > Industrial ethernet > Type
Select **Profinet + IIoT** or **EtherNet/IP + IIoT**
2. Set the IP address of the IND360:
Communication > Industrial Ethernet > IP Address
Default value: 192.168.0.2, use proper IP address for your application
3. Set the OPC UA port of the IND360:
Communication > Industrial ethernet > OPC UA port
Default value: 4840

Connect the OPC UA client device to IND360 using IND360's Industrial Ethernet port.

D.1.2. Connection steps on OPC UA client

To setup an OPC UA connection on the client device such as a PC, use the following parameters:

- IP address: as set on the IND360 before
 - OPC UA port: as set on the IND360 before
- (sometimes IP address and OPC UA port are set in one step such as "opc.tcp://192.168.0.2:4840")
- Set "Security settings" to "None" and "Authentication" to "Anonymous"

In the following example, we use UaExpert, which is a widely used OPC UA client software.

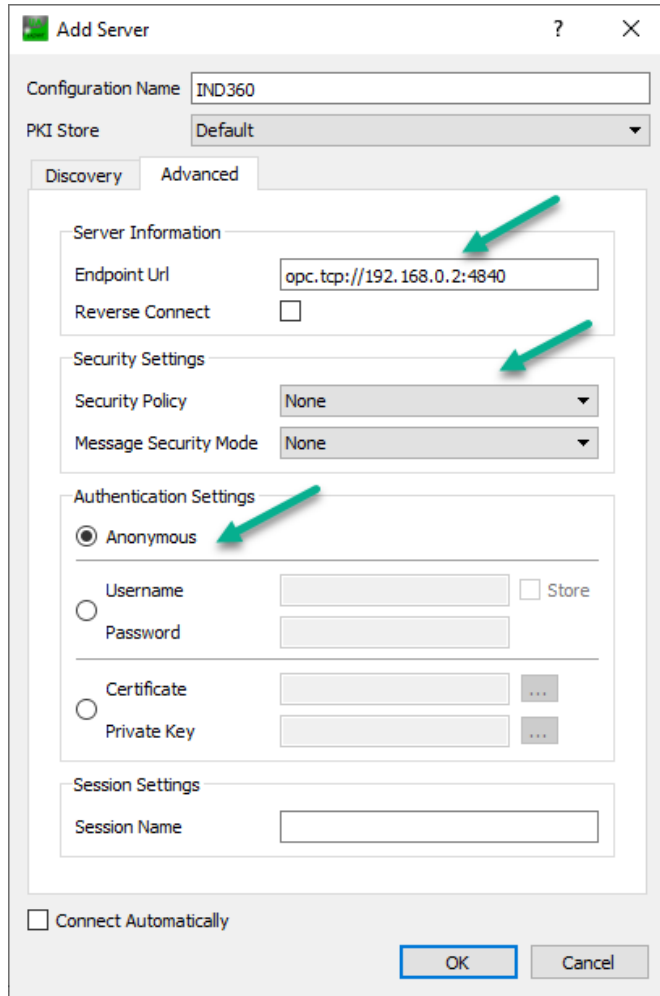

Figure D-1 Example Server Settings

When the connection is established, the IND360 Project and the IND360 Device Set are displayed as in the following example.

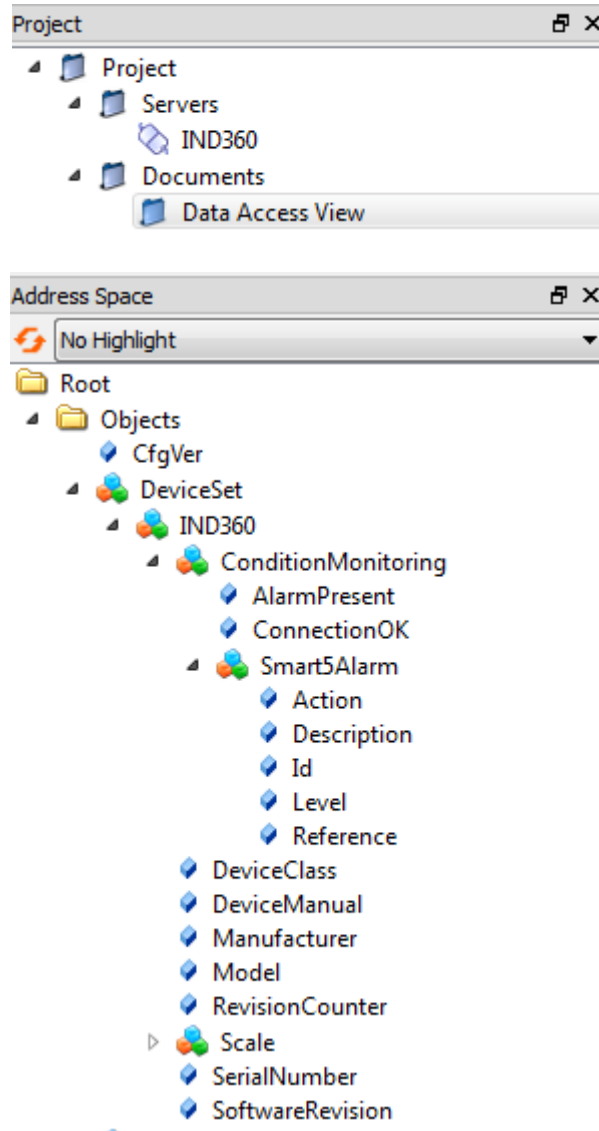

Figure D-2 Project and Address Space in UaExpert

D.2. List of Nodes of IND360

The nodes listed in the following tables are supported by IND360.

D.2.1. IND360 General nodes (device identification nodes)

Table D-1 IND360 General Nodes

Node	Data Type	Description
DeviceClass	String	For IND360: Weighing Device
DeviceManual	String	Address where to find the User Manual of the Device For IND360: www.mt.com/ind-IND360-downloads

Node	Data Type	Description
Manufacturer	LocalizedText	Localized manufacturer name For IND360: "en", "METTLER TOLEDO"
Model	LocalizedText	Localized model type, including scale interface For IND360 e.g.: "en", "IND360 POWERCELL"
RevisionCounter	UInt32	Reserved
SerialNumber	String	Serial number of the weighing terminal, 10 characters E.g. C315964864
SoftwareRevision	String	Software revision number E.g. 1.04.5203

D.2.2. IND360 ConditionMonitoring nodes

Table D-2 IND360 Condition Monitoring Nodes

Node	Data Type	Description
AlarmPresent	Byte	Number of the present alarms 0 = no alarm
Connection OK	Boolean	Connection status true / false
Smart5Alarm		
Action	LocalizedText	Action to rectify the alarm
Description	LocalizedText	Description of Smart5 Alarm
ID	UInt32	Smart5 ID
Level	Byte	Smart5 Level (1 – 5)
Reference	String	Serial number

D.2.3. IND360 Scale > CurrentWeight / RegisteredWeight nodes

Table D-3 IND360 Weight Nodes

Node	Data Type	Description
CenterOfZero	Boolean	Zero captured true / false
Definition	String	Reserved
Gross	Double	Gross weight value
Net	Double	Net weight value
Overload	Boolean	Overload condition true / false
Tare	Double	Tare weight value
TareMode	TareMode	Tare status 0 = no tare 1 = pushbutton tare 2 = preset tare

Node	Data Type	Description
Underload	Boolean	Underload condition true / false
ValuePrecision	Double	Readability E.g. 0.02
WeightStable	Boolean	Stable weight condition true / false
EngineeringUnitsMT		Weight unit
Description	LocalizedText	Description of the weight unit E.g. "en", "kilogram"
DisplayName	LocalizedText	Display name of the weight unit E.g. "en", "kg"
UnitId	Int32	Unit ID of the weight unit according to OPC UA standard 4674125 --> g 4933453--> kg 4997714 --> lb 5525061 --> t 5461070 --> ton 4280410 --> ozt 5197402 --> oz 5064525 --> mg 19779 --> ug

D.2.4. Overview of the IND360 > Scale commands

Table D-4 IND360 Scale Command Methods

Command	Data Type	Description
ClearTare	Method	Clear the tare weight
RegisterWeight	Method	Register the weight
SetPresetTare	Method	Set the tare value
SetTare	Method	Tare the scale
SetZero	Method	Set the scale to zero

D.3. Troubleshooting

If you have trouble connecting to IND360 from an OPC UA client, the root cause could be:

- No physical connection between the OPC UA client and IND360
- Access to IND360 blocked by the IT network such as a firewall or switch configuration
- Wrong network parameter settings on IND360 or on the OPC UA client

The following troubleshooting guide helps you to solve the problem step by step:

1. Verify hardware connection.

Use the industrial ethernet connector for OPC UA communication.



DIN version



Panel version



Harsh version

Figure D-3 IND360 OPC UA Physical Connection

2. Verify connection between IND360 and the OPC UA client.

Use "Ping" in the command window on the client PC to verify whether the client can access the IND360. Example: >ping 192.168.0.2. You will find the IP address of IND360 OPC UA communication under parameter "Communication > Industrial Ethernet > IP Address". Note this is **not** the same IP address as the web interface.

Ping successful

```

Command Prompt

Pinging 192.168.0.2 with 32 bytes of data:
Reply from 192.168.0.2: bytes=32 time<1ms TTL=255
Reply from 192.168.0.2: bytes=32 time=1ms TTL=255
Reply from 192.168.0.2: bytes=32 time=1ms TTL=255
Reply from 192.168.0.2: bytes=32 time=1ms TTL=255

Ping statistics for 192.168.0.2:
    Packets: Sent = 4, Received = 4, Lost = 0 (0% loss),
    Approximate round trip times in milli-seconds:
        Minimum = 0ms, Maximum = 1ms, Average = 0ms
    
```

Ping unsuccessful

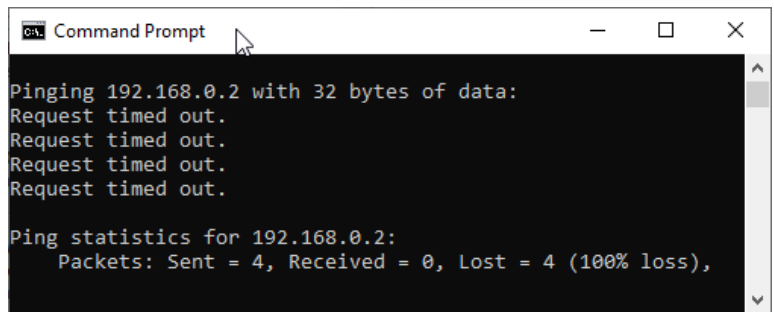

```
Command Prompt
Pinging 192.168.0.2 with 32 bytes of data:
Request timed out.
Request timed out.
Request timed out.
Request timed out.

Ping statistics for 192.168.0.2:
    Packets: Sent = 4, Received = 0, Lost = 4 (100% loss),
```

If ping is successful: go to step 3 and check whether all settings are right.

If ping is unsuccessful:

- connect a PC (or laptop) directly to IND360's industrial ethernet port (see step 1)
- adapt network settings of the PC and make sure the PC and the IND360 are in the same sub-network. For example:

IND360 IP = 192.168.0.2

PC IP = 192.168.0.15

Subnet mask = 255.255.255.0

- ping IND360 from the PC. Example: >ping 192.168.0.2
 - o If ping is successful directly from the PC:
 - Contact IT department as the IT network might be blocking the traffic.
 - o If ping is unsuccessful directly from the PC:
 - Contact METTLER TOLEDO support organization

3. Verify OPC UA related parameter setting on IND360 and the client when ping works.

Settings on IND360:

- Communication > Industrial Ethernet > Type: either "Profinet + IloT" or "EtherNet/IP + IloT" needs to be selected
- Communication > Industrial Ethernet > IP Address: set the desired IP address. Default is 192.168.0.2
- Communication > Industrial Ethernet > OPC UA port: set the desired OPC UA port number. Default is 4840

Settings on the OPC UA client:

- IP Address: set same IP address as in 3b)
- OPC UA port: set same port number as in 3c)
Sometimes IP address and OPC UA Port are included in the server Url setting, such as "opc.tcp://192.168.0.2:4840"
- Security settings: set to "None"
- Authentication setting: set to "Anonymous"

If all parameter settings are correct, IND360 answers to ping command, but OPC UA communication still cannot be established:

- check with responsible IT person, whether OPC UA communication is allowed on the IT network e.g. network port blocked
- contact METTLER TOLEDO support organization

E. REST API Communication

The REST API allows users to access IND360 from an external device such as a PC and execute the following operations:

- Read weighing results such as Gross, Tare and Net values
- Read the device's Serial Number and FW Revision Number

Note: The REST API on IND360 is currently a preview version, subject to change.

E.1. Establishing the Connection

E.1.1. Preparation of the IND360

Set the following parameters using the web interface.

1. Enable REST API communication:
Set **Communication > Service > Access Security > JSON** to **Enable**
2. Set the IP address of the IND360:
Communication > Service > Service ethernet > IP Address
Default value is 192.168.0.8, use proper IP address for your application

Connect the REST API client device to IND360 using IND360's service port.

E.2. Read Weighing Results

Enter the following address in the address line of a web browser or e.g. via Postman in the GET command line, for example:

192.168.0.8/Json/Measurement/Weight

192.168.0.8 is the default IP address, use the actual IP address in your application

The following information is received. **Example:** Analog scale

```

1  {
2    "Message": {
3      "Measurement": [
4        {
5          "Weight": [
6            {
7              "UnitOfMeasureCode": "kg",
8              "Gross": 12.94,
9              "Net": 12.94,
10             "Tare": 0,
11             "WeightStable": false,
12             "CenterOfZero": false,
13             "Overload": false,
14             "Underload": false,
15             "TareMode": 0
16           }
17         ]
18       }
19     ]
20   }
21 }

```

Figure E-1 IND360 Rest API Formatted Weight Response

Table E-1 IND360 Weight Measurement Data

Item	Data Type	Description	Possible values
Analog, POWERCELL and Precision			
UnitOfMeasureCode	String	Weight unit	Weight unit of IND360, e.g. "kg"
Gross	Number	Gross weight value	
Net	Number	Net weight value	
Tare	Number	Tare weight value	
WeightStable	Boolean	Stable weight condition	true / false
CenterOfZero	Boolean	Zero captured	true / false
Overload	Boolean	Overload condition	true / false
Underload	Boolean	Underload condition	true / false

Item	Data Type	Description	Possible values
TareMode	Number	Tare status	0 = no tare 1 = pushbutton tare 2 = preset tare
POWERCELL only: Weight of each sensor			
Weight/UnitOfMeasureCode	String	Weight unit of load cell 1	
Weight/Gross	Number	Gross weight of load cell 1	
Weight/UnitOfMeasureCode	String	Weight unit of load cell 2	
Weight/Gross	Number	Gross weight of load cell 2	

E.3. Read Device Information

Enter the following address in the address line of a web browser or e.g. via Postman in the GET command line:

192.168.0.8/Json/ConfigTransaction/DeviceComponent

192.168.0.8 is the default IP address, use the actual IP address in your application

The following information is received. **Example:** Analog scale

```

1  |
2  |   "Message": {
3  |     "ConfigTransaction": [
4  |       {
5  |         "DeviceComponent": [
6  |           {
7  |             "Base": {
8  |               "DeviceClass": "Weighing Device",
9  |               "Manufacturer": "Mettler-Toledo",
10 |               "Model": "IND360",
11 |               "SerialNumber": "C315964864",
12 |               "SoftwareRevision": "1.04.5202"
13 |             },
14 |             "Scale": [
15 |               {
16 |                 "ScaleType": "Analog",
17 |                 "Capacity": "60 kg",
18 |                 "Increment": "0.02 kg",
19 |                 "GeoCode": 20,
20 |                 "FilterEnvironment": "Standard",
21 |                 "FilterLimitFrequency": "5"
22 |               }
23 |             ]
24 |           }
25 |         ]
26 |       }

```

Figure E-2 IND360 Rest API Formatted Device Information

			Scale interface		
Item	Description	Analog	POWERCELL	Precision	
Base	DeviceClass (String)	For IND360: Weighing Device	✓	✓	✓
	Manufacturer (String)	Manufacturer name For IND360: Mettler-Toledo	✓	✓	✓
	Model (String)	Model type: IND360	✓	✓	✓
	SerialNumber (String)	Serial number of the weighing terminal, 10 characters E.g. C315964864	✓	✓	✓
	SoftwareRevision (String)	Software revision number E.g. 1.04.5202	✓	✓	✓
Scale	ScaleType (String)	Type of the weighing interface, e.g. Analog, Powercell, Precision	✓	✓	✓
	Capacity (String)	Capacity of the weighing platform	✓	✓	✓
	Increment (String)	Increment of the weighing platform	✓	✓	✓
	GeoCode (Number)	Local Geo code	✓	✓	–
	FilterEnvironment (String)	Filter adaptation according to the environment Possible settings: Very Stable, Stable, Standard [default], Unstable, Very Unstable	✓	–	✓
	FilterLimitFrequency (Number)	Marks the point at which the filtering process begins (in Hz)	✓	–	✓

E.4. Troubleshooting

If you have trouble connecting to IND360 from a REST API client, the root cause could be:

- No physical connection between the client and IND360
- Access to IND360 blocked in the IT network such as a firewall or switch configuration
- Wrong network parameter settings on IND360

The follow troubleshooting guide helps you solve the problem step by step:

1. Verify hardware connection.

Use the service port on IND360 for REST API communication.



DIN version



Panel version



Harsh version

Figure E-3 IND360 Rest API Physical Connection

2. Verify connection between IND360 and the REST API client.

First, make sure the JSON REST API function is enabled. Communication > Service > Access Security > JSON (Enable)

If you can access the IND360 web interface (type the IND360 service port IP address in Microsoft Edge, or Chrome browser), it means the connection works. In this case, if you cannot get data, contact your IT department to confirm that the REST API port is not blocked.

If you cannot access the web interface from the REST API client PC, use "Ping" in the command window on the client PC. Example: >ping 192.168.0.8. You will find the IP address of IND360 service port under parameter "**Communication > Service > Service Ethernet > IP Address**". This is the same IP address as the web interface.

Ping
successful

```
Command Prompt

Pinging 192.168.0.8 with 32 bytes of data:
Reply from 192.168.0.8: bytes=32 time=1ms TTL=60
Reply from 192.168.0.8: bytes=32 time=3ms TTL=60
Reply from 192.168.0.8: bytes=32 time=1ms TTL=60
Reply from 192.168.0.8: bytes=32 time=1ms TTL=60

Ping statistics for 192.168.0.8:
    Packets: Sent = 4, Received = 4, Lost = 0 (0% loss),
    Approximate round trip times in milli-seconds:
        Minimum = 1ms, Maximum = 3ms, Average = 1ms
```

Ping
unsuccessful

```
Command Prompt

Pinging 192.168.0.9 with 32 bytes of data:
Request timed out.
Request timed out.
Request timed out.
Request timed out.

Ping statistics for 192.168.0.9:
    Packets: Sent = 4, Received = 0, Lost = 4 (100% loss),
```

If ping is successful:

- Confirm with the IT department that accessing the REST API port is allowed

If ping is unsuccessful:

- connect a PC (or laptop) directly to IND360's service port (see step 1)
- adapt network settings of the PC and make sure the PC and the IND360 are in the same sub-network. For example:

IND360 IP = 192.168.0.8

PC IP = 192.168.0.34

Subnet mask = 255.255.255.0

- ping IND360 from the PC. Example: >ping 192.168.0.8
 - o If ping is successful directly from the PC:
 - Contact IT department as the IT network may block the traffic.
 - o If ping is unsuccessful directly from the PC:
 - Contact Mettler Toledo support organization

F. GEO Codes

The GEO code feature provided in the IND360 indicator permits calibration readjustment due to changes in elevation or latitude without reapplying test weights. This adjustment assumes a previously accurate calibration was done with the GEO code set properly for that original location and that the GEO code for the new location can be accurately determined. The procedure for using this feature is as follows.

F.1. Original Site Calibration

1. Use the GEO code chart (Table F-1) on the following pages to determine the GEO code for the current altitude and location at which the scale will be calibrated.
2. Enter that GEO value into the GEO code parameter in setup at **Scale > Calibration**.
3. Immediately after entering the GEO code, perform a zero and span adjustment using accurate test weights.
4. Exit the setup menu tree.
5. The scale can now be used in its new location.

F.2. New Site GEO Code Adjustment

When a indicator is to be reinstalled at a different geographic location, gravitational and altitude changes can be accounted for by following these steps. Note that this procedure is not necessary if an on-site recalibration is performed.

1. Use the GEO code chart (Table F-1) on the following pages to determine the GEO code for the new altitude and location at which the scale will be used.
2. Enter that GEO value into the GEO code parameter in Setup at **Scale > Calibration**.
3. Immediately after entering the GEO code, exit the setup menu tree. DO NOT perform a normal calibration.

The calibration has now been adjusted for the differences in gravity from the original site of calibration to the new site of use.

- Using the GEO code value for calibration adjustment is not as accurate as re-applying certified test weights and re-calibrating the scale in a new location.

Table F-1: GEO Adjustment Values

Latitude North or South, in Degrees and Minutes	Height Above Sea Level, in Meters										
	0	325	650	975	1300	1625	1950	2275	2600	2925	3250
	325	650	975	1300	1625	1950	2275	2600	2925	3250	3575
	Height Above Sea Level, in Feet										
	0	1060	2130	3200	4260	5330	6400	7460	8530	9600	10660
1060	2130	3200	4260	5330	6400	7460	8530	9600	10660	11730	
0° 0'–5° 46'	5	4	4	3	3	2	2	1	1	0	0
5° 46'–9° 52'	5	5	4	4	3	3	2	2	1	1	0
9° 52'–12° 44'	6	5	5	4	4	3	3	2	2	1	1
12° 44'–15° 6'	6	6	5	5	4	4	3	3	2	2	1
15° 6'–17° 0'	7	6	6	5	5	4	4	3	3	2	2
17° 10'–19° 2'	7	7	6	6	5	5	4	4	3	3	2
19° 2'–20° 45'	8	7	7	6	6	5	5	4	4	3	3
20° 45'–22° 22'	8	8	7	7	6	6	5	5	4	4	3
22° 22'–23° 54'	9	8	8	7	7	6	6	5	5	4	4
23° 54'–25° 21'	9	9	8	8	7	7	6	6	5	5	4
25° 21'–26° 45'	10	9	9	8	8	7	7	6	6	5	5
26° 45'–28° 6'	10	10	9	9	8	8	7	7	6	6	5
28° 6'–29° 25'	11	10	10	9	9	8	8	7	7	6	6
29° 25'–30° 41'	11	11	10	10	9	9	8	8	7	7	6
30° 41'–31° 56'	12	11	11	10	10	9	9	8	8	7	7
31° 56'–33° 9'	12	12	11	11	10	10	9	9	8	8	7
33° 9'–34° 21'	13	12	12	11	11	10	10	9	9	8	8
34° 21'–35° 31'	13	13	12	12	11	11	10	10	9	9	8
35° 31'–36° 41'	14	13	13	12	12	11	11	10	10	9	9
36° 41'–37° 50'	14	14	13	13	12	12	11	11	10	10	9
37° 50'–38° 58'	15	14	14	13	13	12	12	11	11	10	10
38° 58'–40° 5'	15	15	14	14	13	13	12	12	11	11	10
40° 5'–41° 12'	16	15	15	14	14	13	13	12	12	11	11
41° 12'–42° 19'	16	16	15	15	14	14	13	13	12	12	11
42° 19'–43° 26'	17	16	16	15	15	14	14	13	13	12	12
43° 26'–44° 32'	17	17	16	16	15	15	14	14	13	13	12
44° 32'–45° 38'	18	17	17	16	16	15	15	14	14	13	13
45° 38'–46° 45'	18	18	17	17	16	16	15	15	14	14	13
46° 45'–47° 51'	19	18	18	17	17	16	16	15	15	14	14
47° 51'–48° 58'	19	19	18	18	17	17	16	16	15	15	14

Latitude North or South, in Degrees and Minutes	Height Above Sea Level, in Meters										
	0	325	650	975	1300	1625	1950	2275	2600	2925	3250
	325	650	975	1300	1625	1950	2275	2600	2925	3250	3575
	Height Above Sea Level, in Feet										
	0	1060	2130	3200	4260	5330	6400	7460	8530	9600	10660
1060	2130	3200	4260	5330	6400	7460	8530	9600	10660	11730	
48° 58'–50° 6'	20	19	19	18	18	17	17	16	16	15	15
50° 6'–51° 13'	20	20	19	19	18	18	17	17	16	16	15
51° 13'–52° 22'	21	20	20	19	19	18	18	17	17	16	16
52° 22'–53° 31'	21	21	20	20	19	19	18	18	17	17	16
53° 31'–54° 41'	22	21	21	20	20	19	19	18	18	17	17
54° 41'–55° 52'	22	22	21	21	20	20	19	19	18	18	17
55° 52'–57° 4'	23	22	22	21	21	20	20	19	19	18	18
57° 4'–58° 17'	23	23	22	22	21	21	20	20	19	19	18
58° 17'–59° 32'	24	23	23	22	22	21	21	20	20	19	19
59° 32'–60° 49'	24	24	23	23	22	22	21	21	20	20	19
60° 49'–62° 9'	25	24	24	23	23	22	22	21	21	20	20
62° 9'–63° 30'	25	25	24	24	23	23	22	22	21	21	20
63° 30'–64° 55'	26	25	25	24	24	23	23	22	22	21	21
64° 55'–66° 24'	26	26	25	25	24	24	23	23	22	22	21
66° 24'–67° 57'	27	26	26	25	25	24	24	23	23	22	22
67° 57'–69° 35'	27	27	26	26	25	25	24	24	23	23	22
69° 5'–71° 21'	28	27	27	26	26	25	25	24	24	23	23
71° 21'–73° 16'	28	28	27	27	26	26	25	25	24	24	23
73° 16'–75° 24'	29	28	28	27	27	26	26	25	25	24	24
75° 24'–77° 52'	29	29	28	28	27	27	26	26	25	25	24
77° 52'–80° 56'	30	29	29	28	28	27	27	26	26	25	25
80° 56'–85° 45'	30	30	29	29	28	28	27	27	26	26	25
85° 45'–90° 00'	31	30	30	29	29	28	28	27	27	26	26

METTLER TOLEDO Service

To protect your product's future:

Congratulations on choosing the quality and precision of METTLER TOLEDO. Proper use according to these instructions and regular calibration and maintenance by our factory-trained service team ensure dependable and accurate operation, protecting your investment. Contact us about a service agreement tailored to your needs and budget.

We invite you to register your product at www.mt.com/productregistration so we can contact you about enhancements, updates and important notifications concerning your product.

www.mt.com/IND360

For more information

Mettler-Toledo, LLC
1900 Polaris Parkway
Columbus, OH 43240

© 2023 Mettler-Toledo, LLC
30654701 Rev. 05, 10/2023



30654701